

Bisectrices de Ángulos (C)

Construya la bisectriz de cada ángulo.

1.

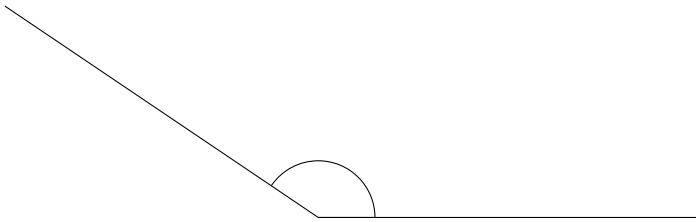

2.

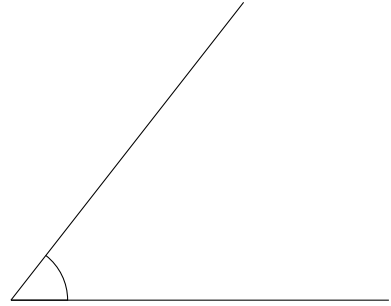

3.

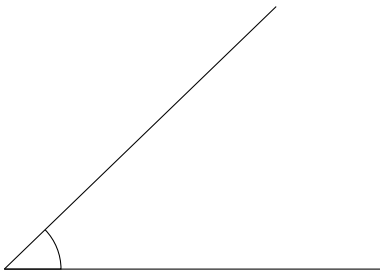

4.

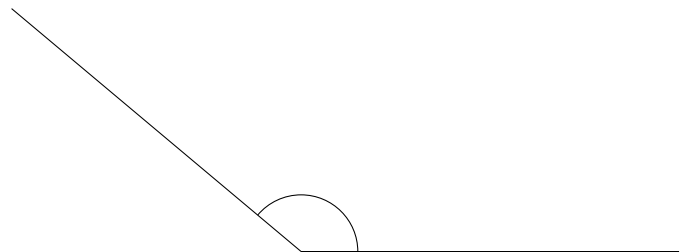

Bisectrices de Ángulos (C) Respuestas

Construya la bisectriz de cada ángulo.

1.

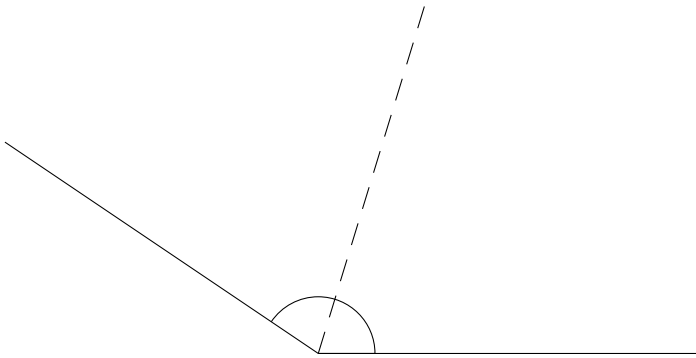

2.

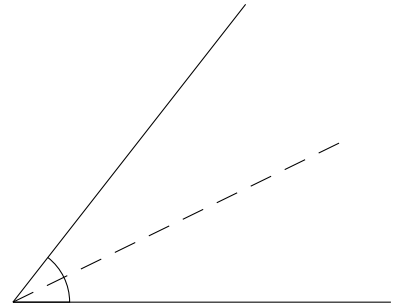

3.

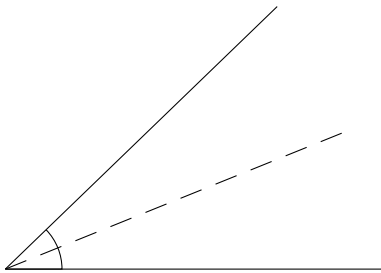

4.

