

# Bisectrices de Ángulos (A)

Construya la bisectriz de cada ángulo.

1.

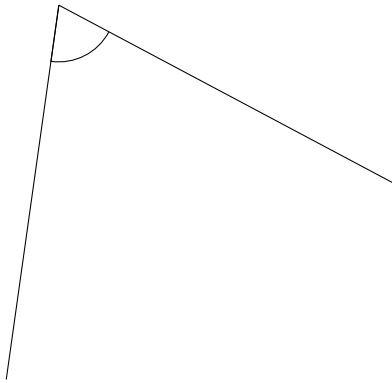

2.

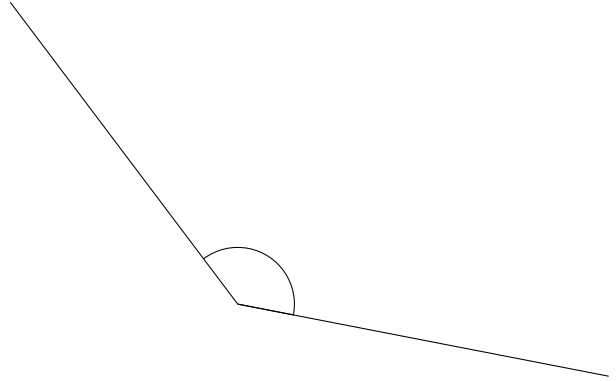

3.

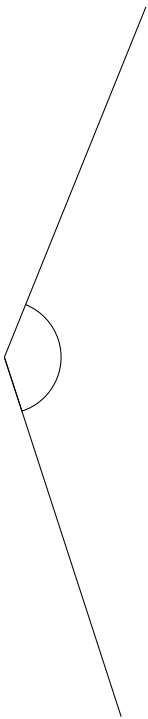

4.

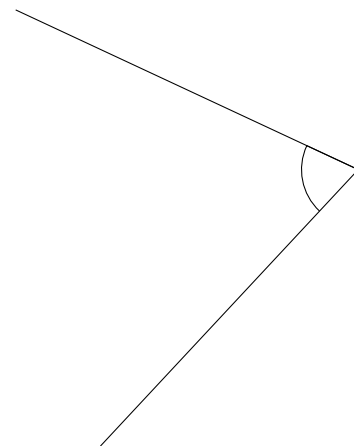

# Bisectrices de Ángulos (A) Respuestas

Construya la bisectriz de cada ángulo.

1.

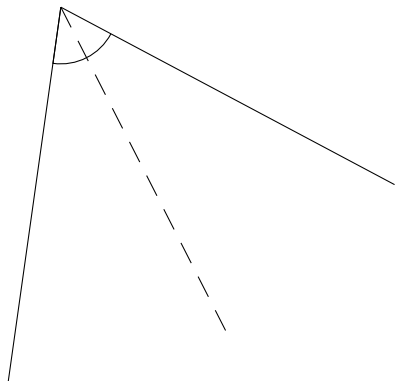

2.

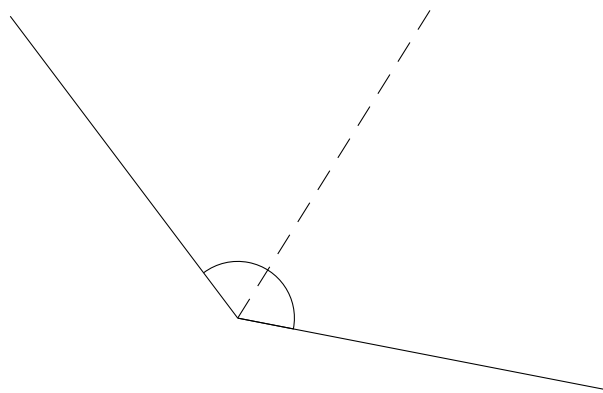

3.

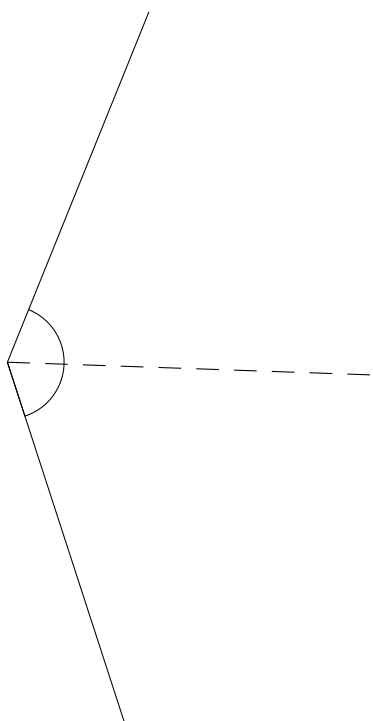

4.

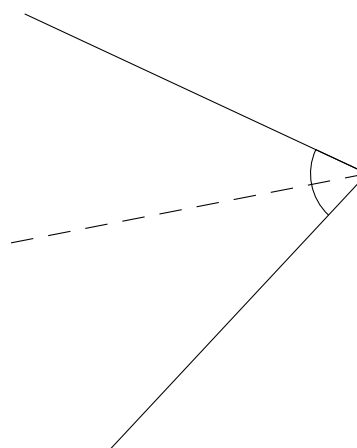

# Bisectrices de Ángulos (B)

Construya la bisectriz de cada ángulo.

1.

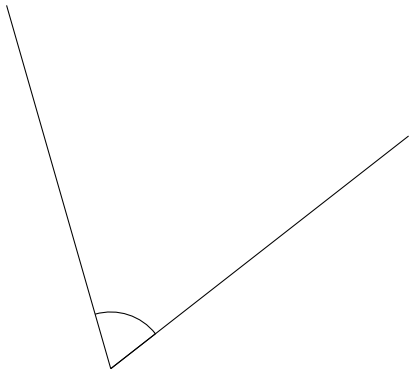

2.

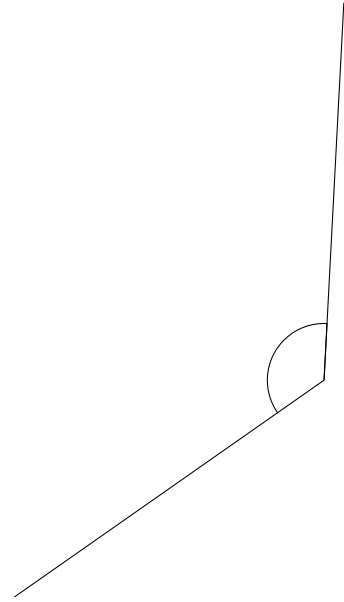

3.

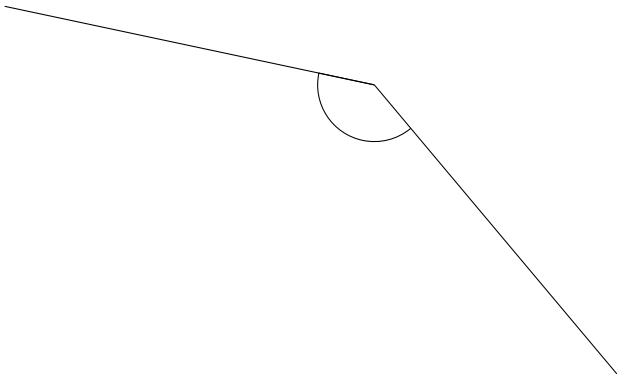

4.

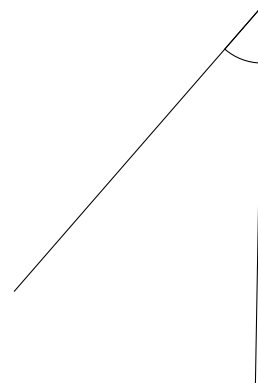

# Bisectrices de Ángulos (B) Respuestas

Construya la bisectriz de cada ángulo.

1.

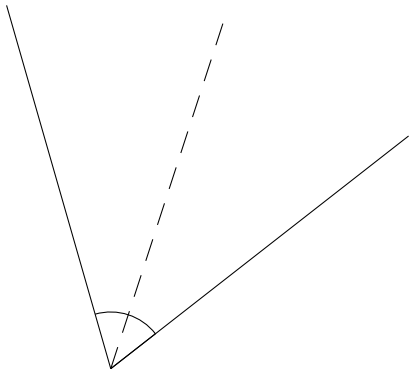

2.

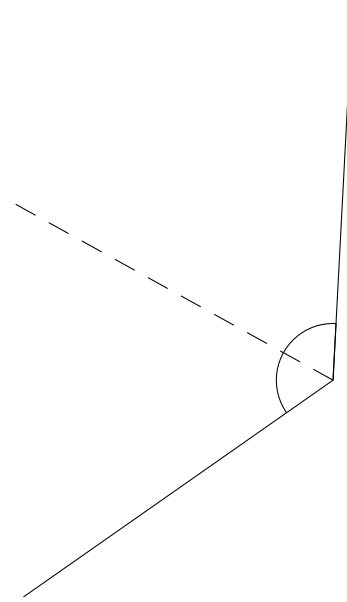

3.

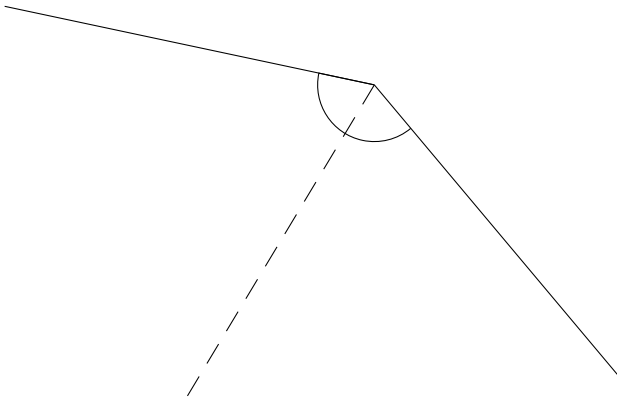

4.

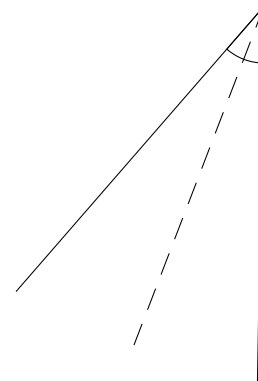

# Bisectrices de Ángulos (C)

Construya la bisectriz de cada ángulo.

1.

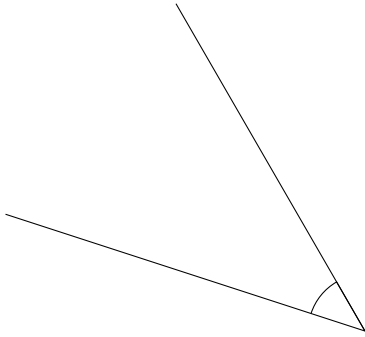

2.

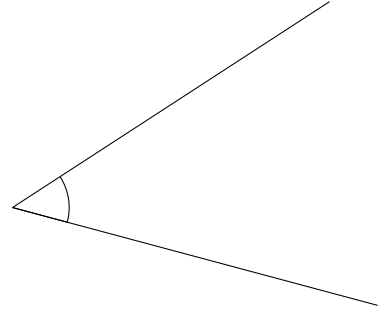

3.

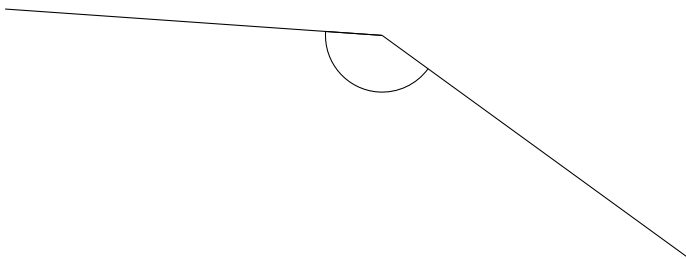

4.

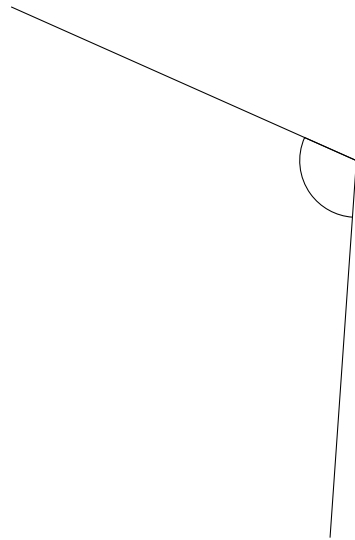

# Bisectrices de Ángulos (C) Respuestas

Construya la bisectriz de cada ángulo.

1.

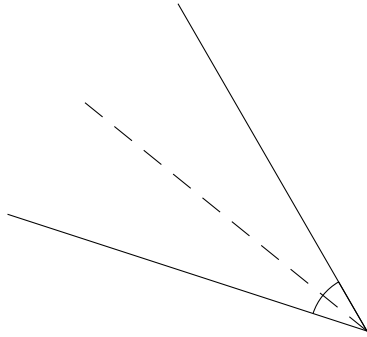

2.

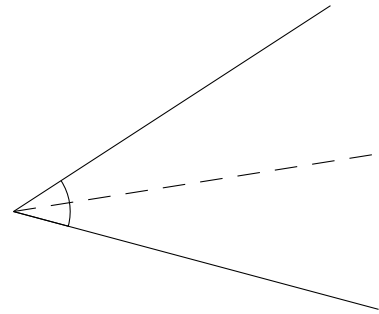

3.

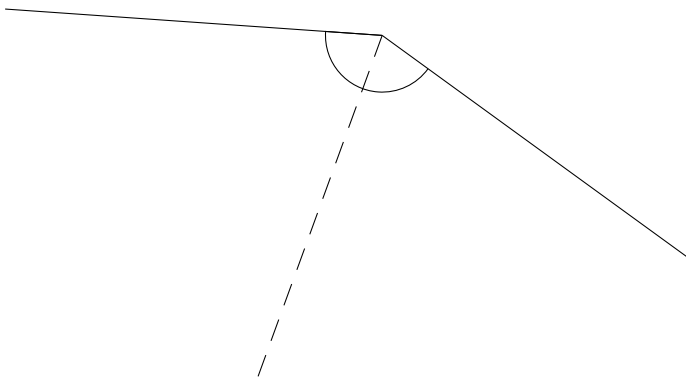

4.

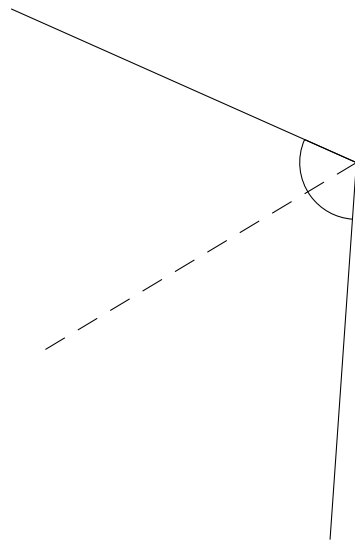

# Bisectrices de Ángulos (D)

Construya la bisectriz de cada ángulo.

1.

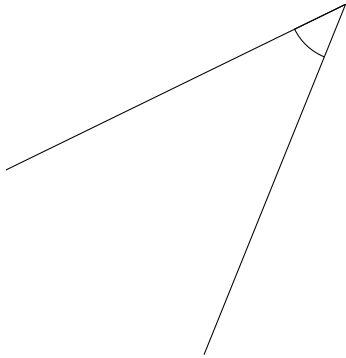

2.

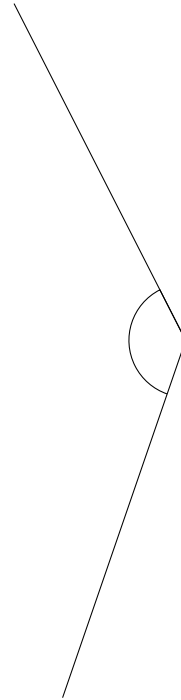

3.

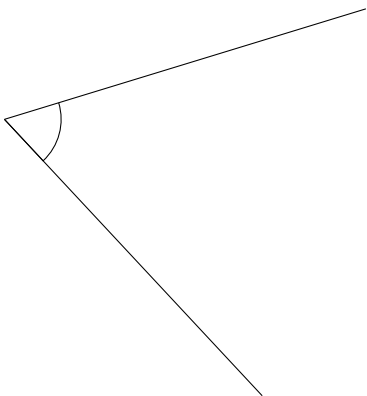

4.

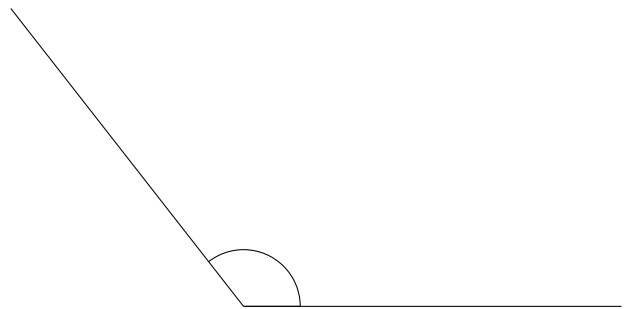

# Bisectrices de Ángulos (D) Respuestas

Construya la bisectriz de cada ángulo.

1.

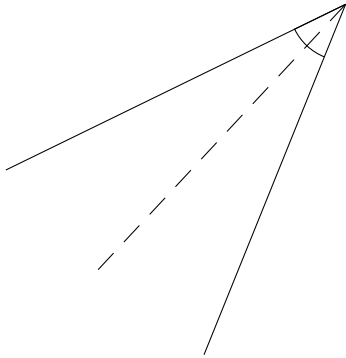

2.

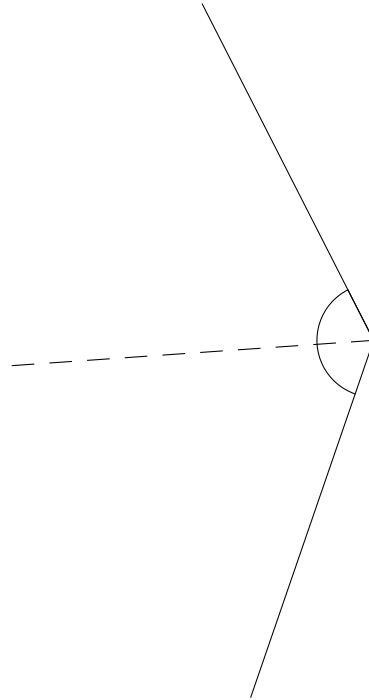

3.

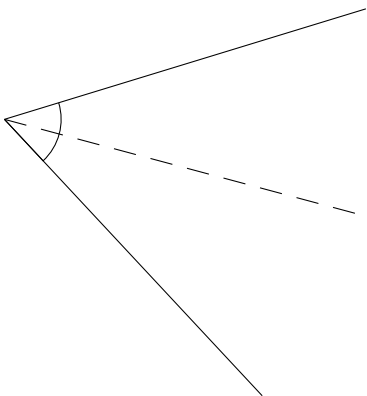

4.

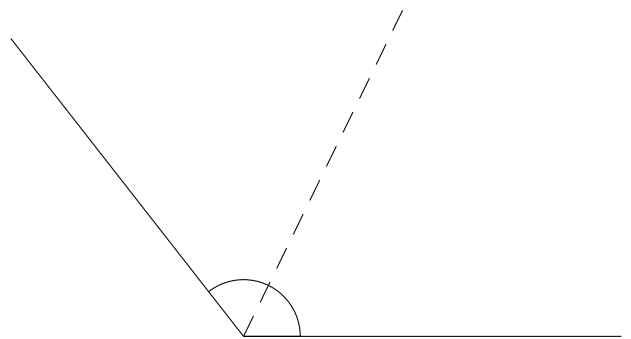



# Bisectrices de Ángulos (E)

Construya la bisectriz de cada ángulo.

1.

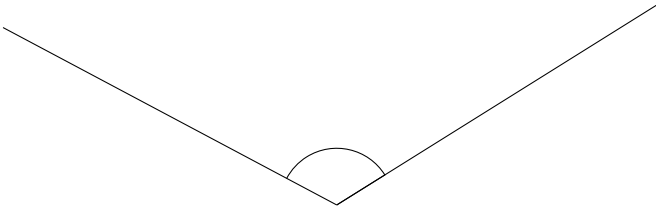

2.

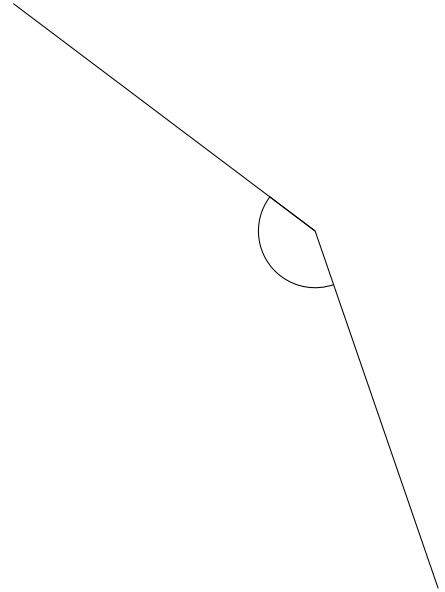

3.

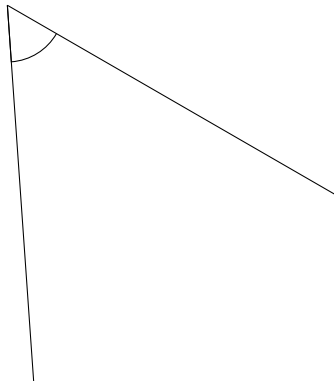

4.

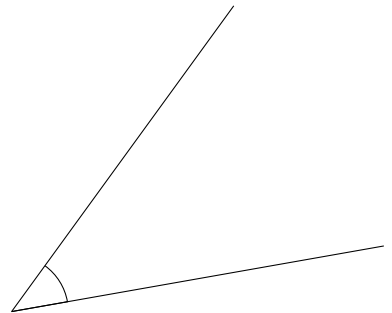

# Bisectrices de Ángulos (E) Respuestas

Construya la bisectriz de cada ángulo.

1.

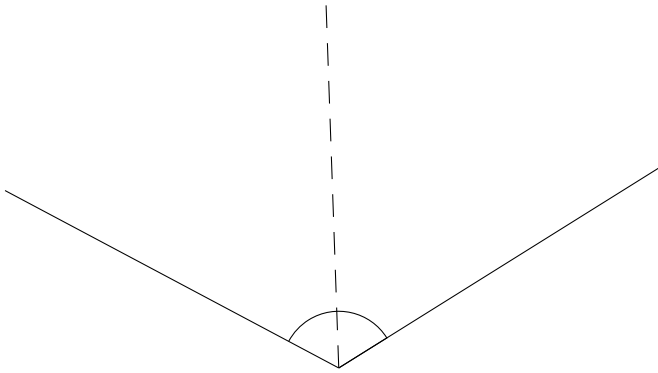

2.

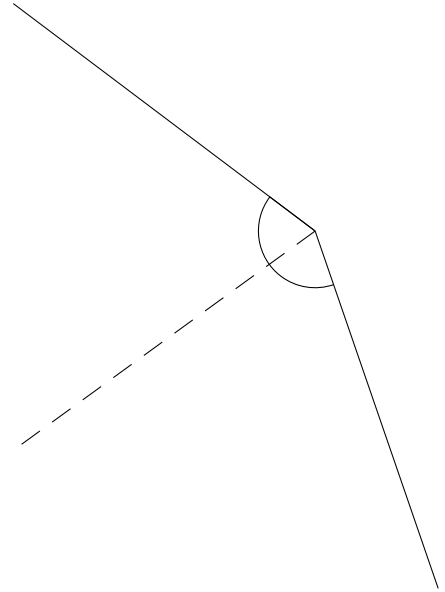

3.

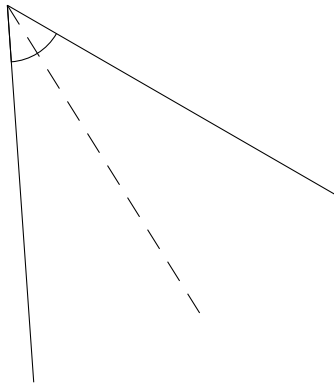

4.

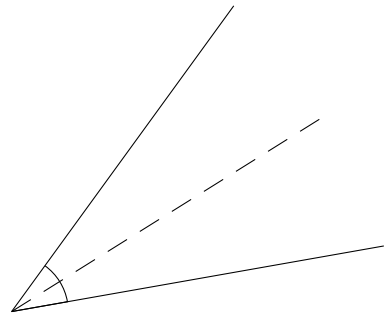

# Bisectrices de Ángulos (F)

Construya la bisectriz de cada ángulo.

1.

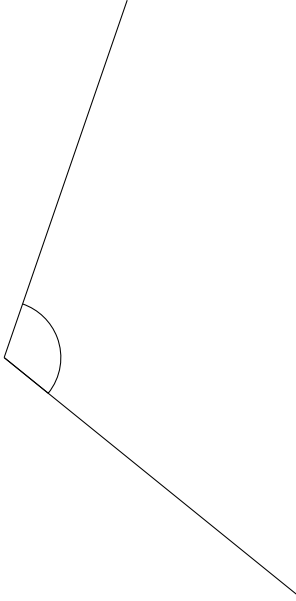

2.

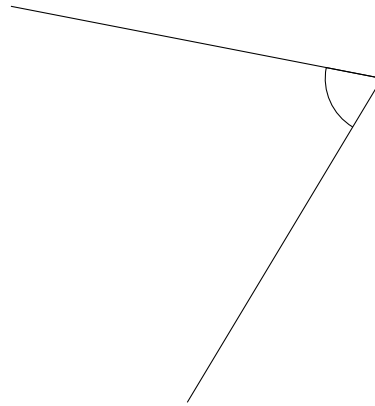

3.

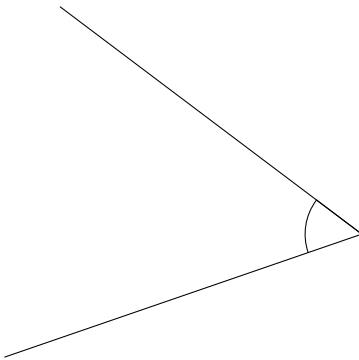

4.

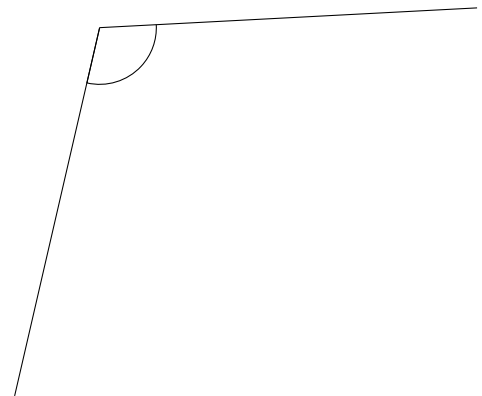

# Bisectrices de Ángulos (F) Respuestas

Construya la bisectriz de cada ángulo.

1.

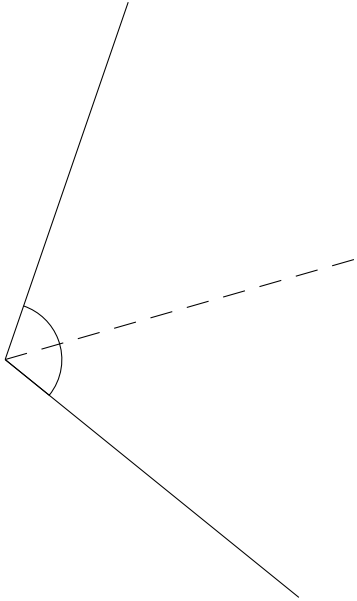

2.

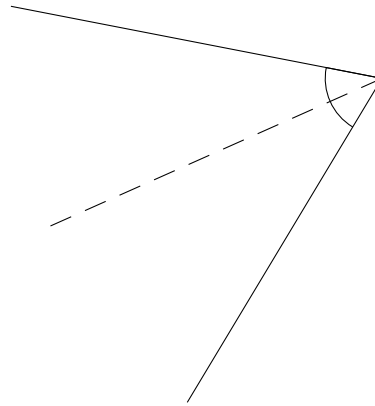

3.

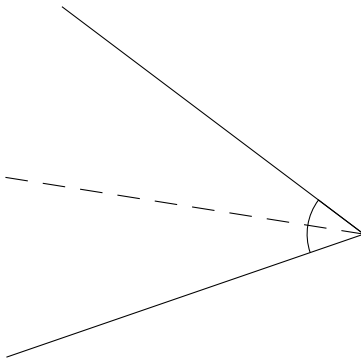

4.

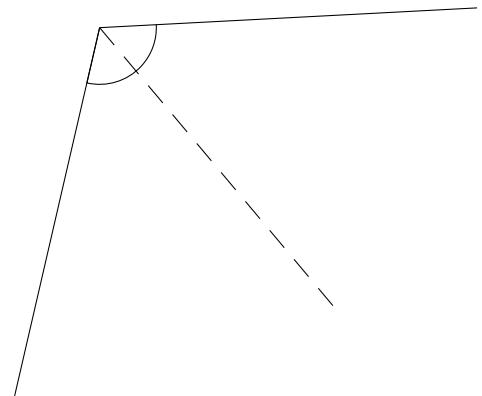

# Bisectrices de Ángulos (G)

Construya la bisectriz de cada ángulo.

1.

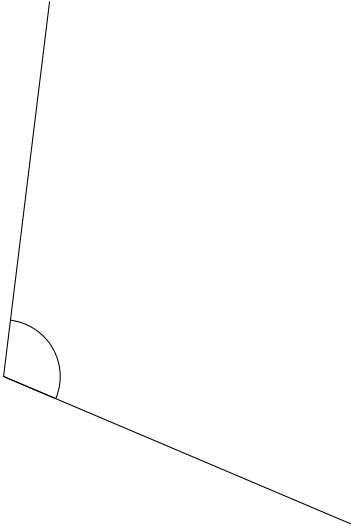

2.

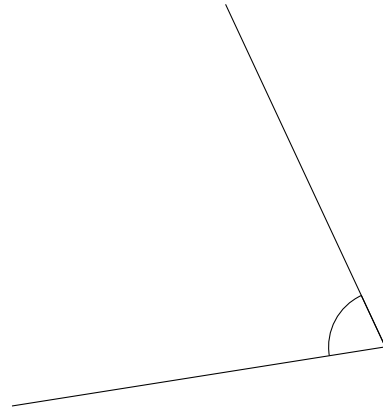

3.

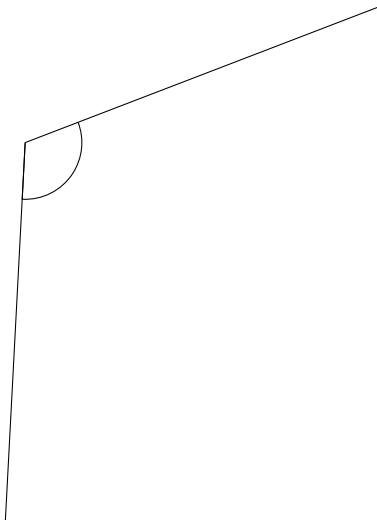

4.

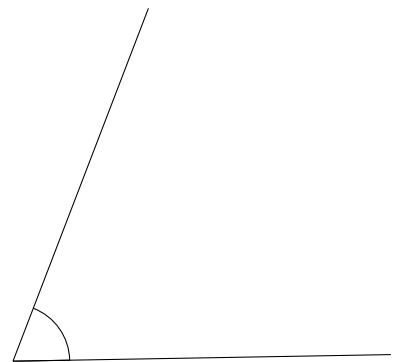

# Bisectrices de Ángulos (G) Respuestas

Construya la bisectriz de cada ángulo.

1.

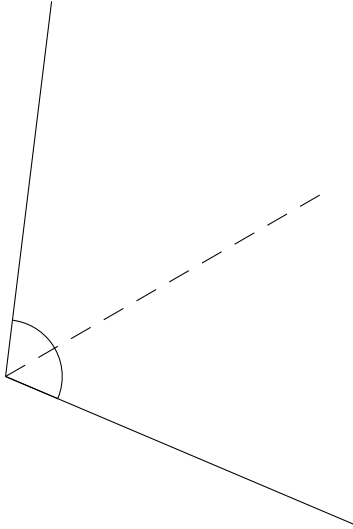

2.

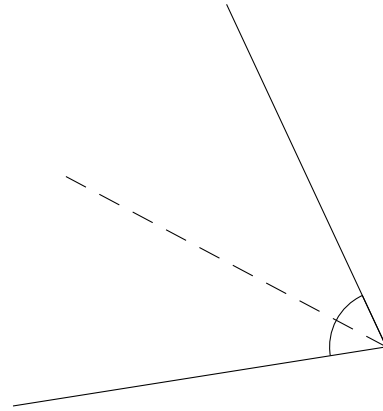

3.

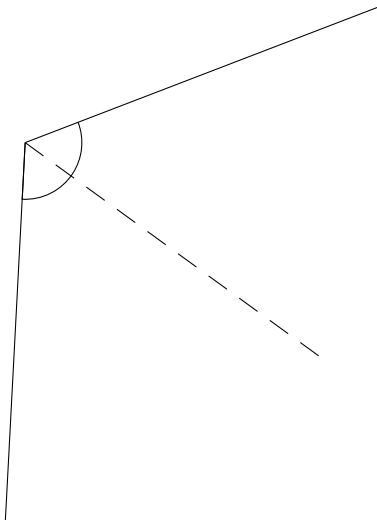

4.

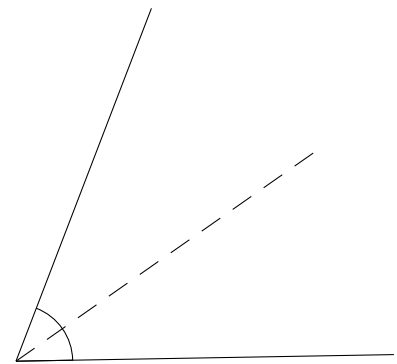

# Bisectrices de Ángulos (H)

Construya la bisectriz de cada ángulo.

1.

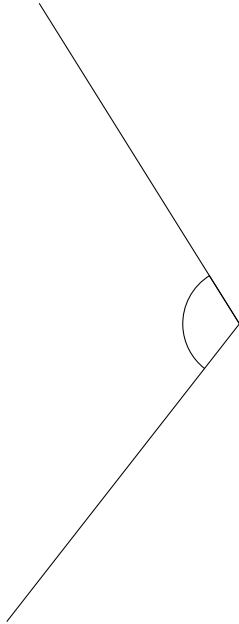

2.

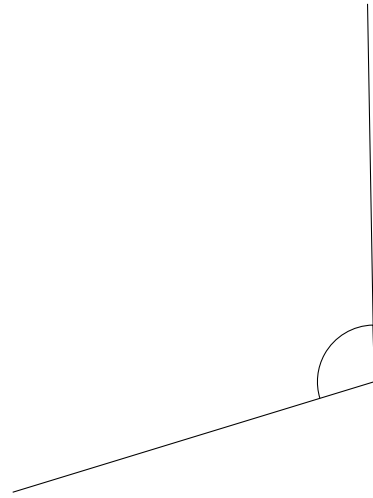

3.

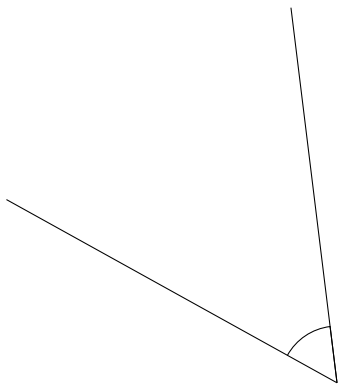

4.

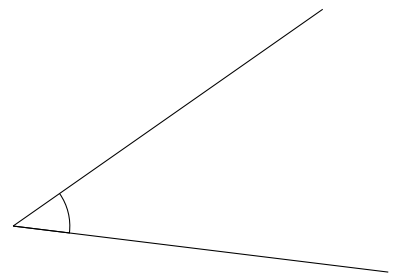

# Bisectrices de Ángulos (H) Respuestas

Construya la bisectriz de cada ángulo.

1.

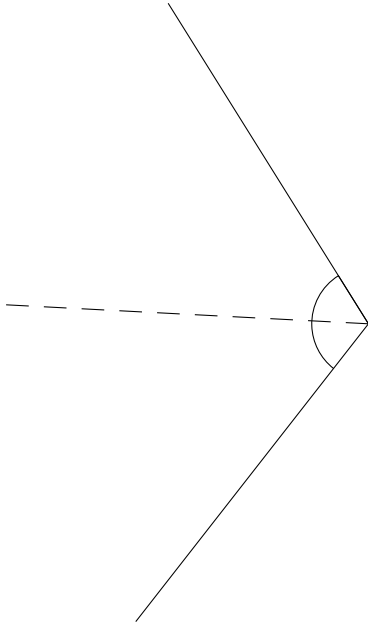

2.

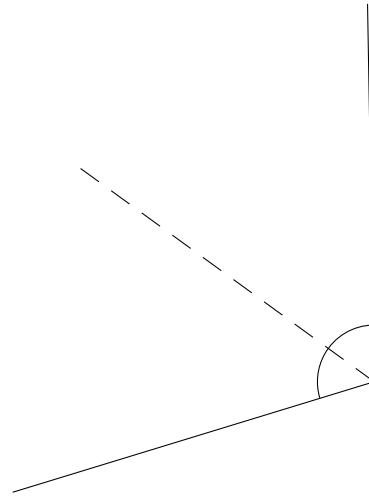

3.

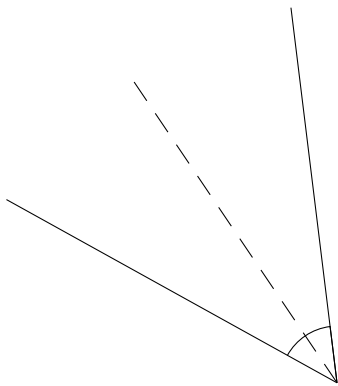

4.

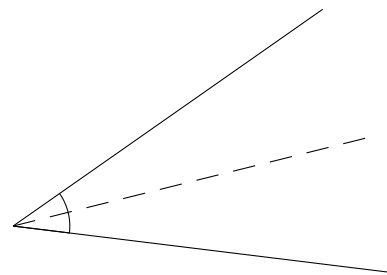



# Bisectrices de Ángulos (I)

Construya la bisectriz de cada ángulo.

1.

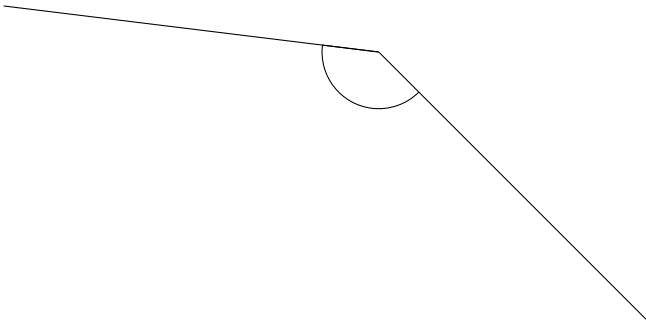

2.

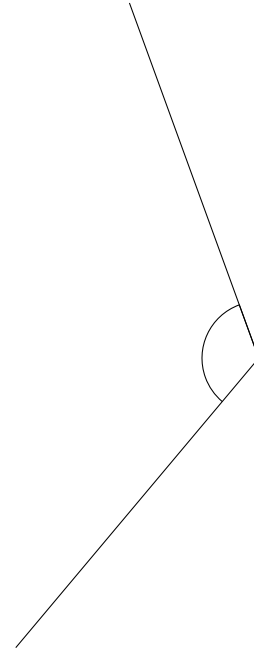

3.

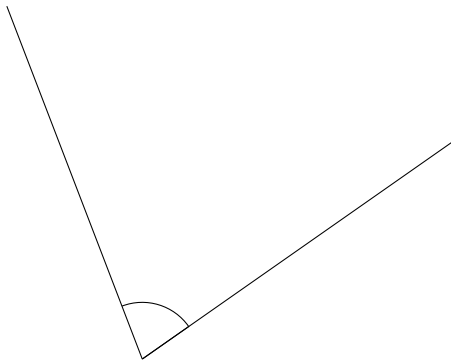

4.

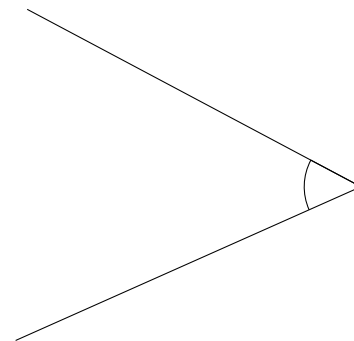

# Bisectrices de Ángulos (I) Respuestas

Construya la bisectriz de cada ángulo.

1.

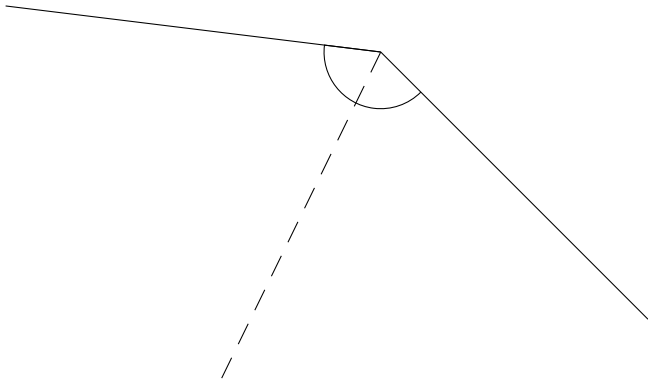

2.

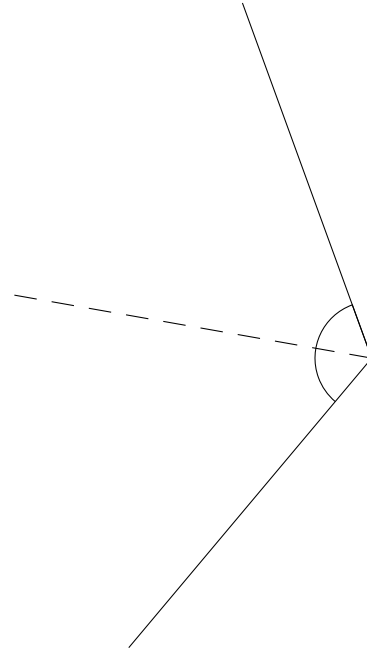

3.

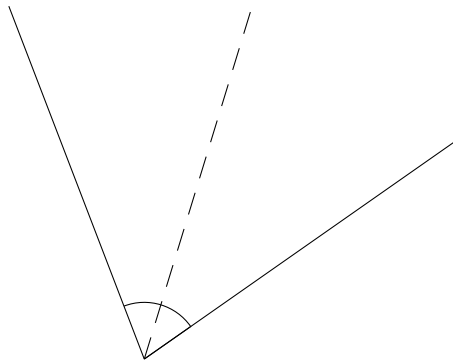

4.

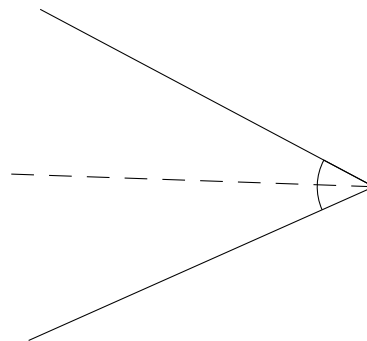

# Bisectrices de Ángulos (J)

Construya la bisectriz de cada ángulo.

1.

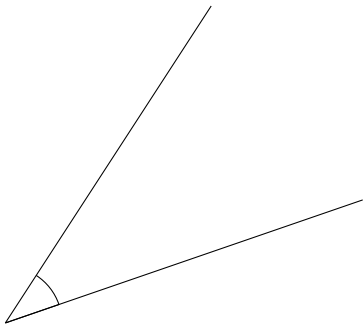

2.

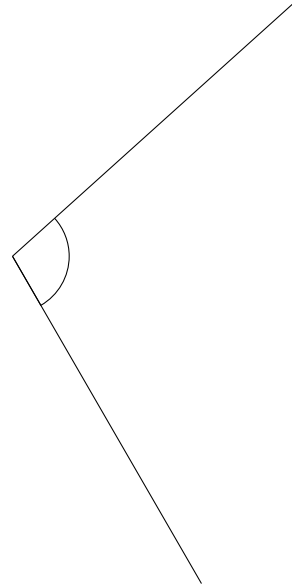

3.

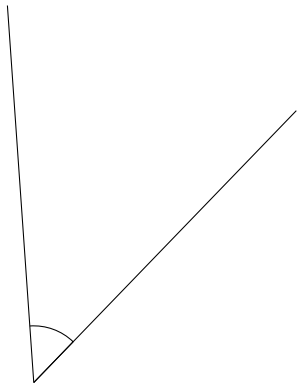

4.

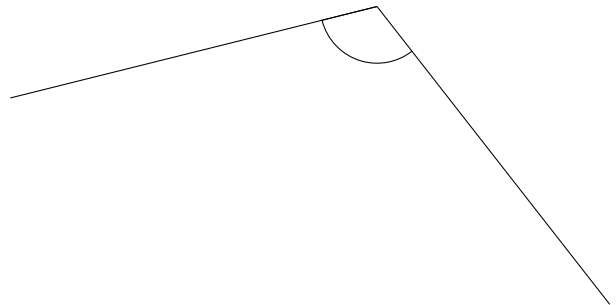

# Bisectrices de Ángulos (J) Respuestas

Construya la bisectriz de cada ángulo.

1.

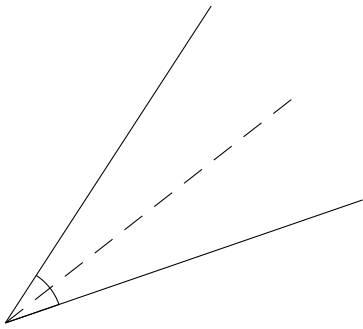

2.

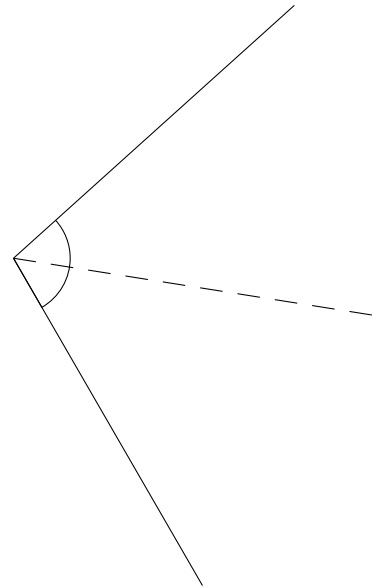

3.

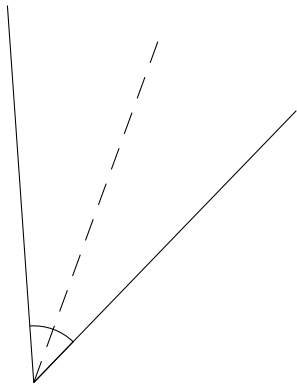

4.

