

Rectas Perpendiculares (A)

Construya la recta perpendicular al segmento que pasa por el punto sin marcar.

1.

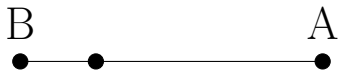

2.

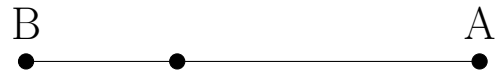

3.



4.



Rectas Perpendiculares (A) Respuestas

Construya la recta perpendicular al segmento que pasa por el punto sin marcar.

1.

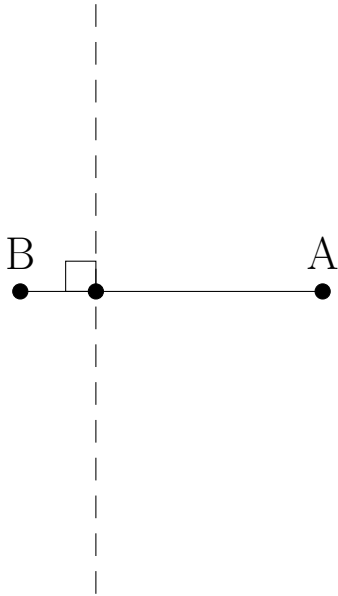

2.

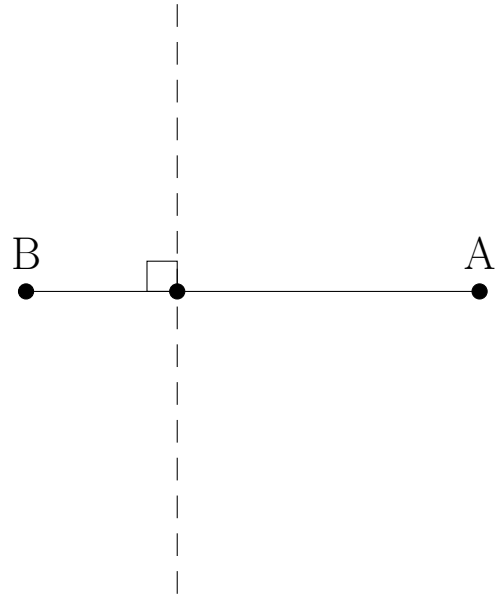

3.

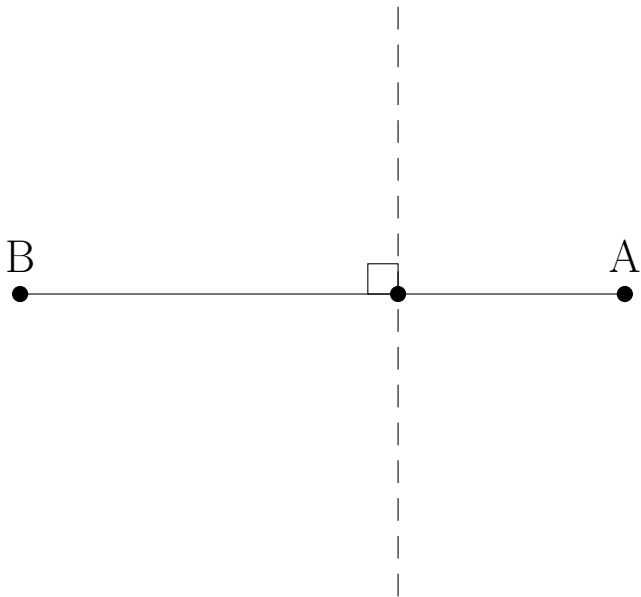

4.

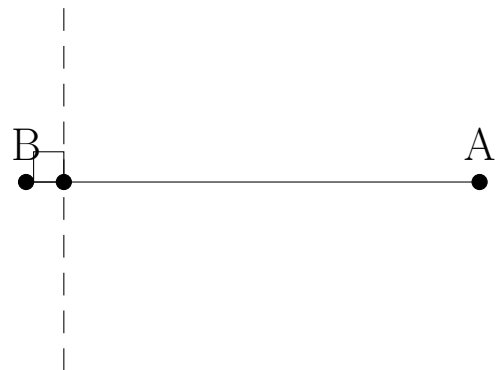

Rectas Perpendiculares (B)

Construya la recta perpendicular al segmento que pasa por el punto sin marcar.

1.

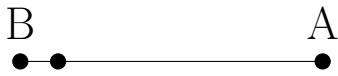

2.

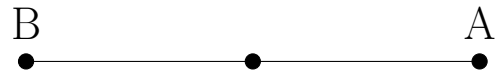

3.



4.



Rectas Perpendiculares (B) Respuestas

Construya la recta perpendicular al segmento que pasa por el punto sin marcar.

1.

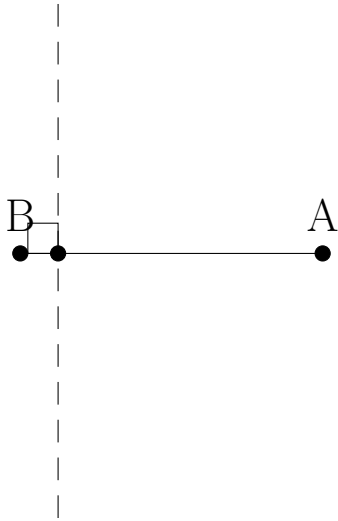

2.

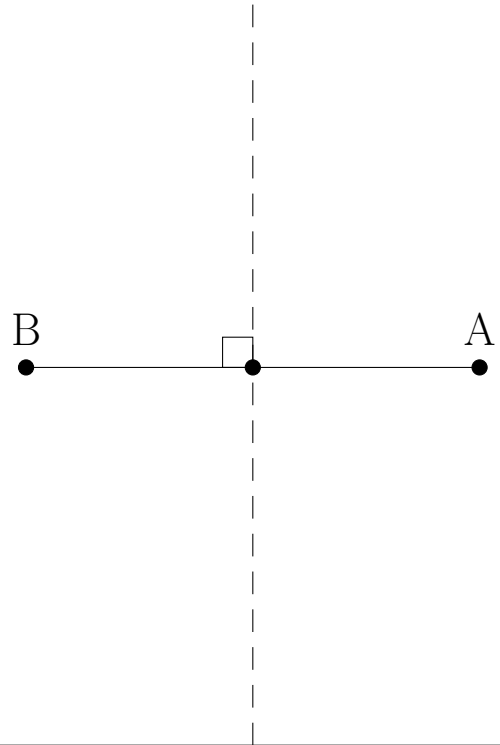

3.

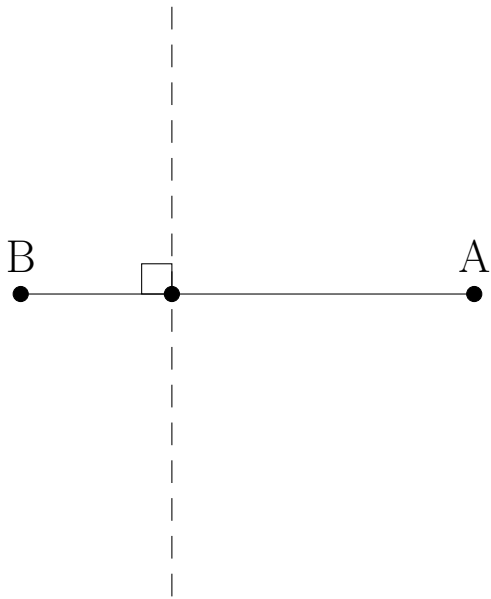

4.

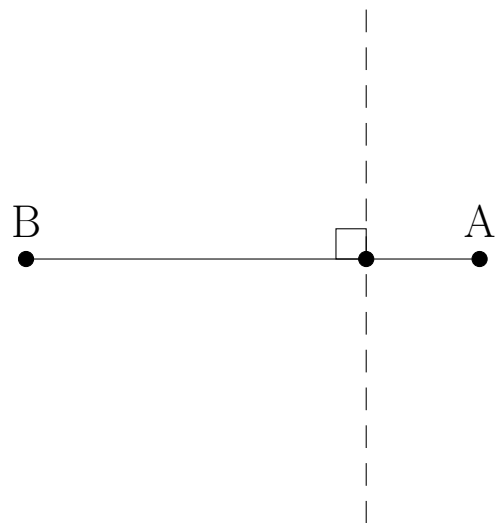

Rectas Perpendiculares (C)

Construya la recta perpendicular al segmento que pasa por el punto sin marcar.

1.

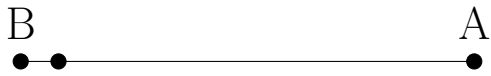

2.

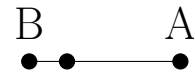

3.

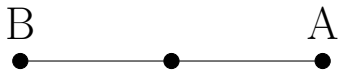

4.

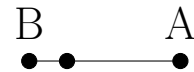

Rectas Perpendiculares (C) Respuestas

Construya la recta perpendicular al segmento que pasa por el punto sin marcar.

1.

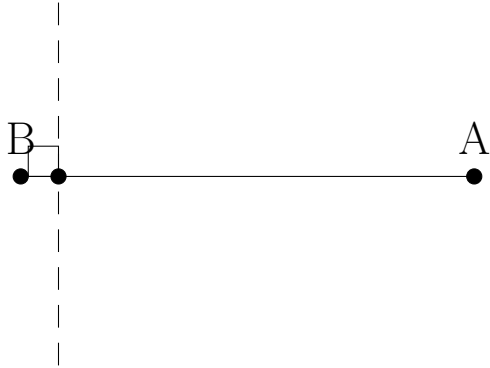

2.

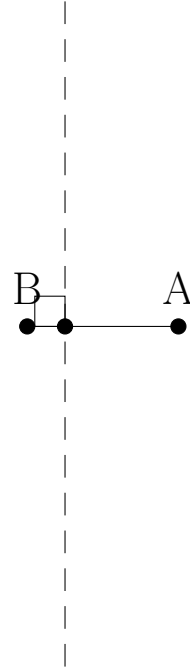

3.

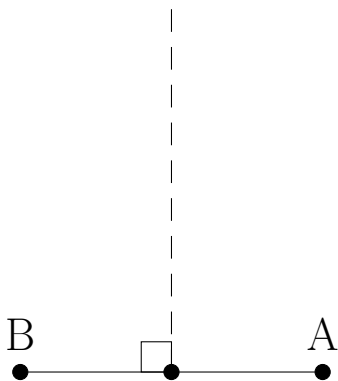

4.

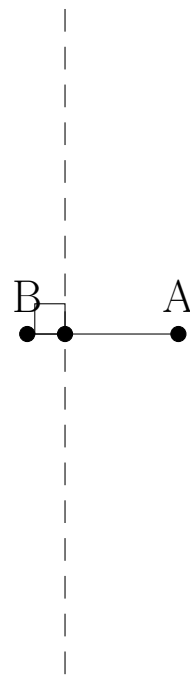

Rectas Perpendiculares (D)

Construya la recta perpendicular al segmento que pasa por el punto sin marcar.

1.



2.



3.



4.



Rectas Perpendiculares (D) Respuestas

Construya la recta perpendicular al segmento que pasa por el punto sin marcar.

1.

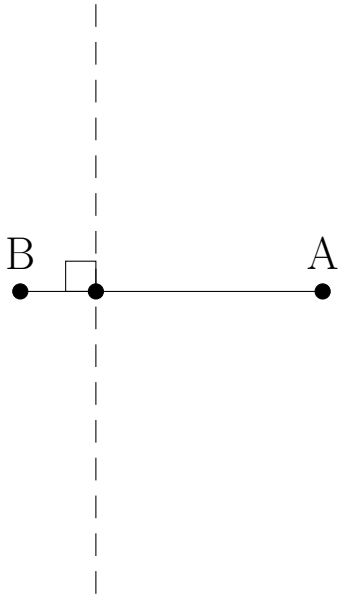

2.



3.

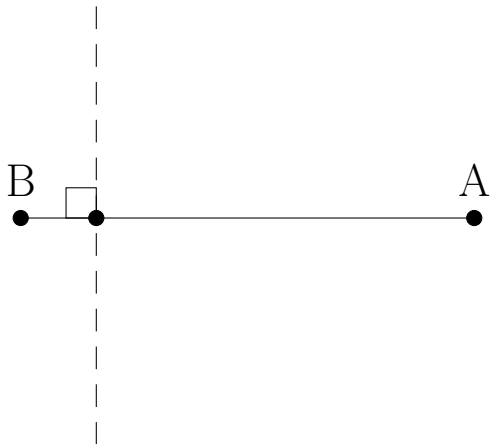

4.

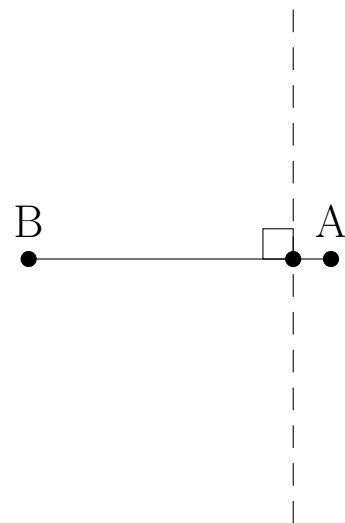

Rectas Perpendiculares (E)

Construya la recta perpendicular al segmento que pasa por el punto sin marcar.

1.

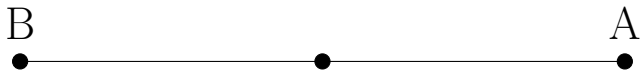

2.



3.



4.



Rectas Perpendiculares (E) Respuestas

Construya la recta perpendicular al segmento que pasa por el punto sin marcar.

1.

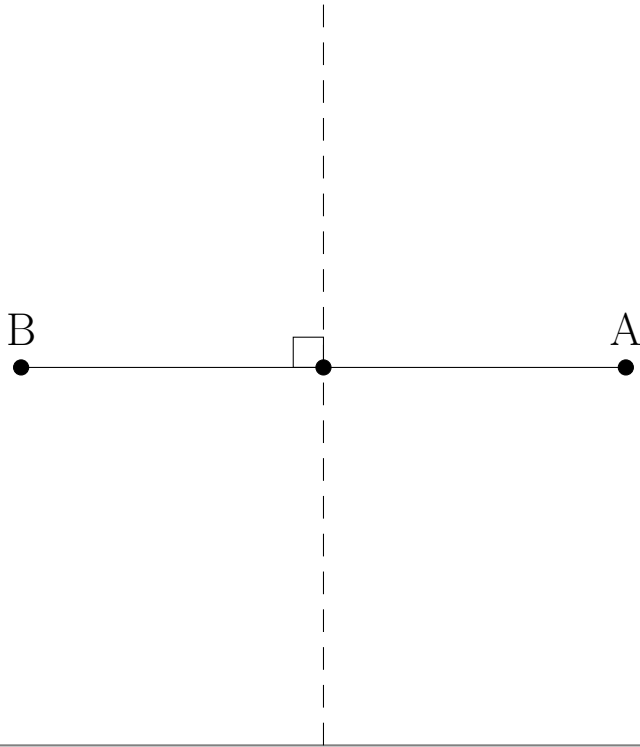

2.



3.

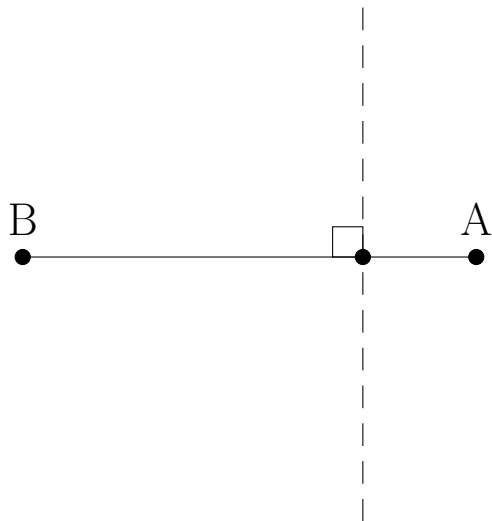

4.

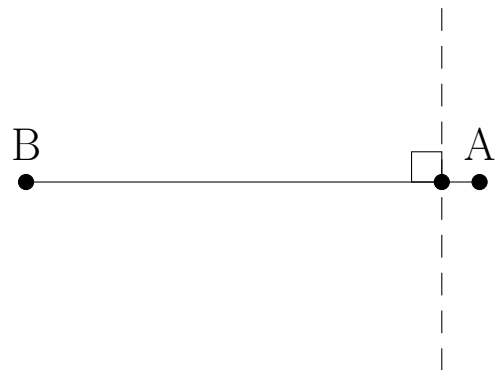

Rectas Perpendiculares (F)

Construya la recta perpendicular al segmento que pasa por el punto sin marcar.

1.



2.



3.



4.



Rectas Perpendiculares (F) Respuestas

Construya la recta perpendicular al segmento que pasa por el punto sin marcar.

1.

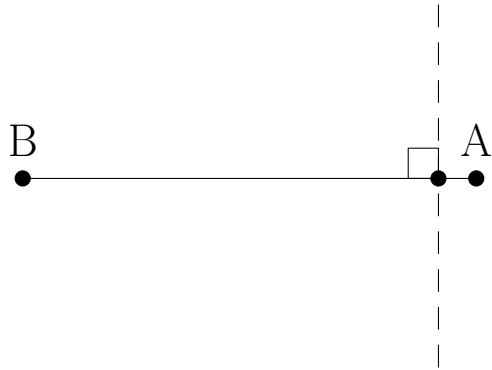

2.

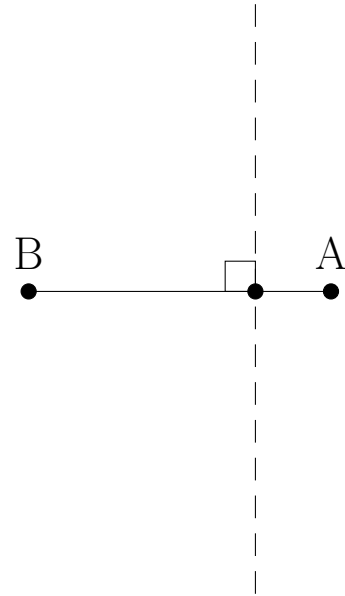

3.

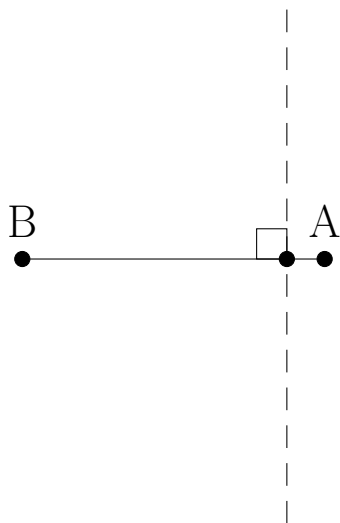

4.

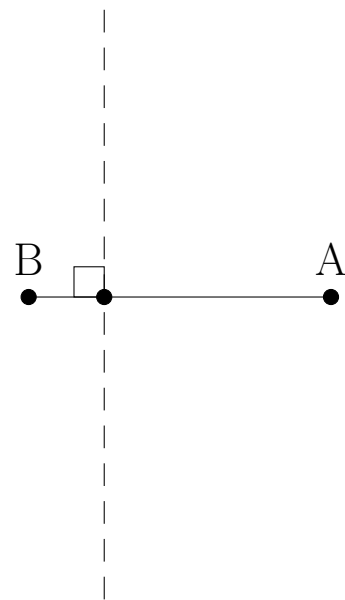

Rectas Perpendiculares (G)

Construya la recta perpendicular al segmento que pasa por el punto sin marcar.

1.



2.



3.



4.



Rectas Perpendiculares (G) Respuestas

Construya la recta perpendicular al segmento que pasa por el punto sin marcar.

1.

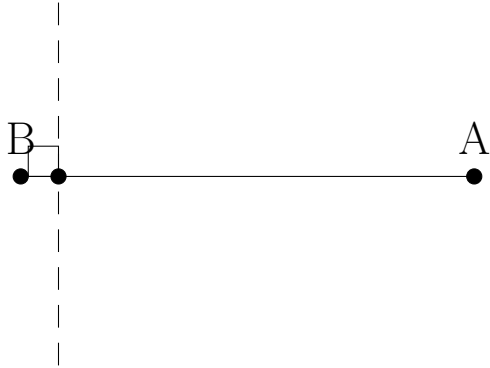

2.

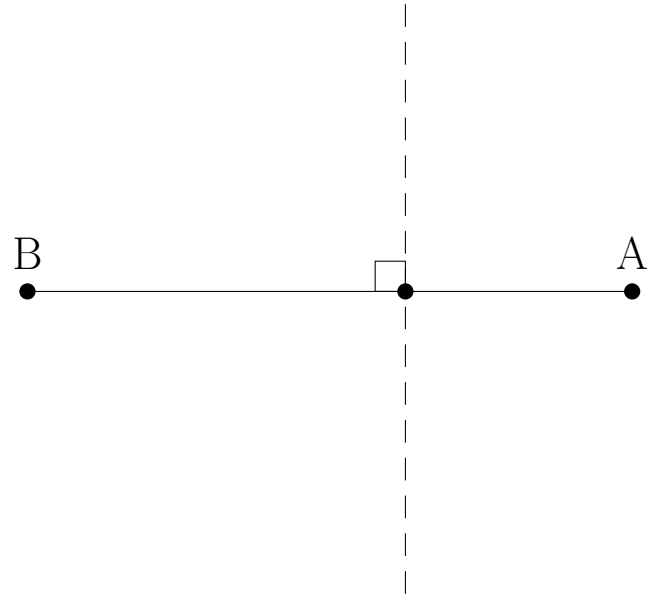

3.



4.

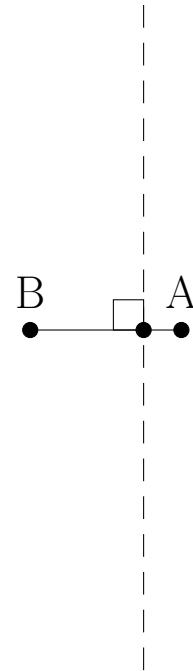

Rectas Perpendiculares (H)

Construya la recta perpendicular al segmento que pasa por el punto sin marcar.

1.



2.



3.



4.



Rectas Perpendiculares (H) Respuestas

Construya la recta perpendicular al segmento que pasa por el punto sin marcar.

1.

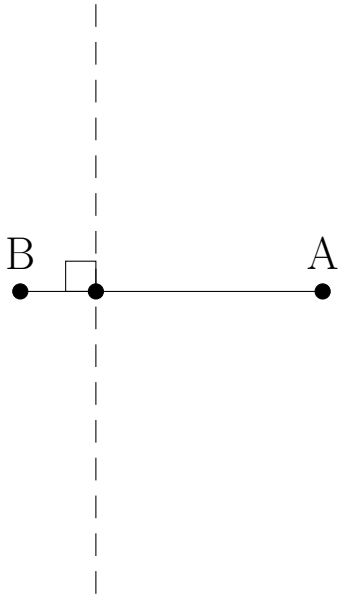

2.

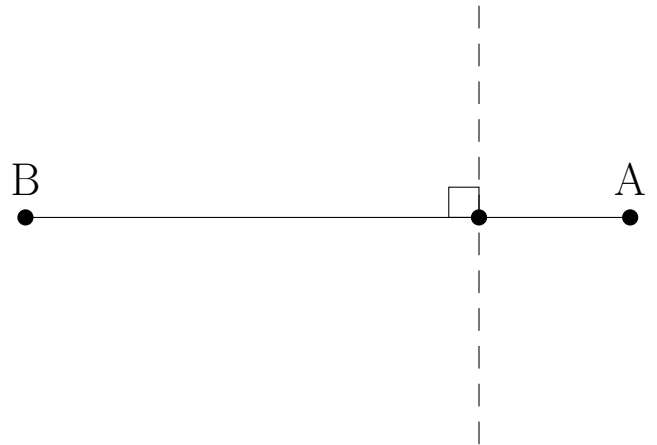

3.

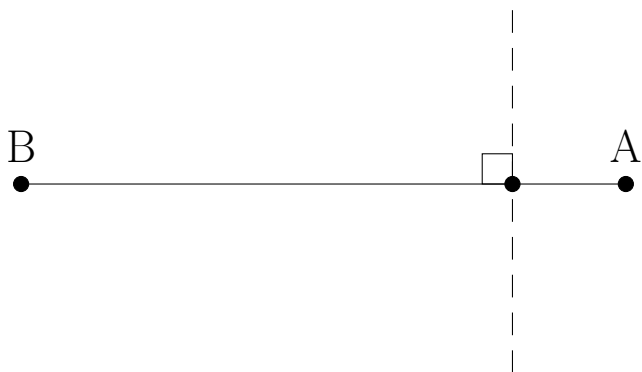

4.

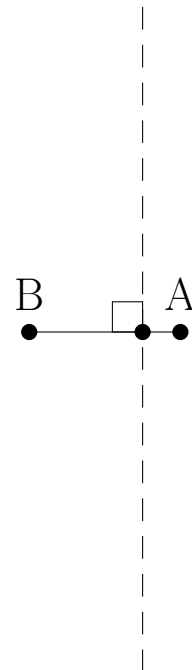

Rectas Perpendiculares (I)

Construya la recta perpendicular al segmento que pasa por el punto sin marcar.

1.

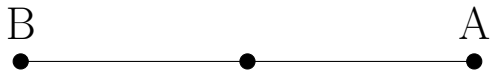

2.



3.



4.



Rectas Perpendiculares (I) Respuestas

Construya la recta perpendicular al segmento que pasa por el punto sin marcar.

1.

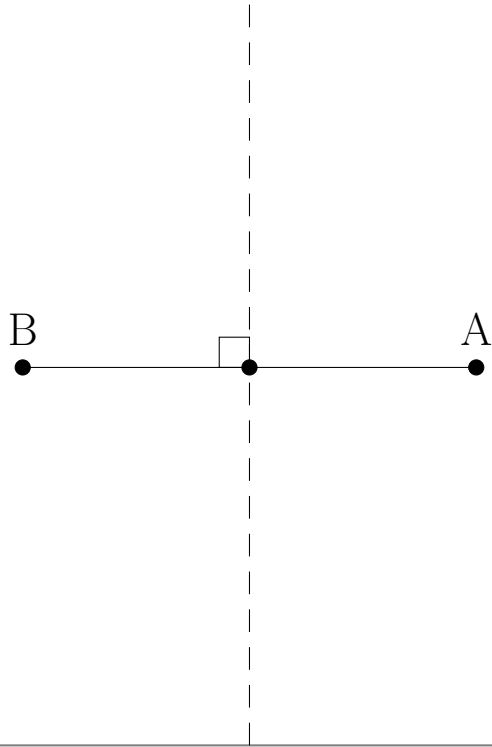

2.

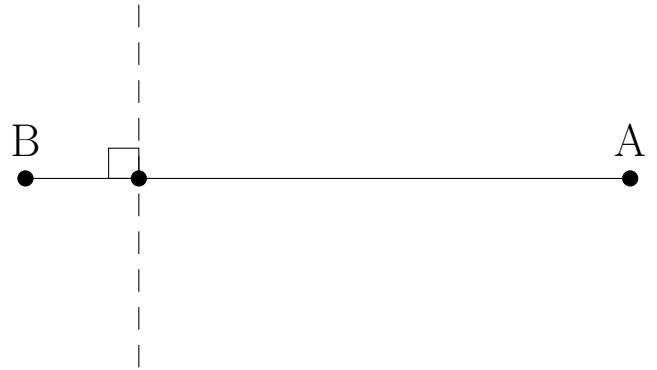

3.

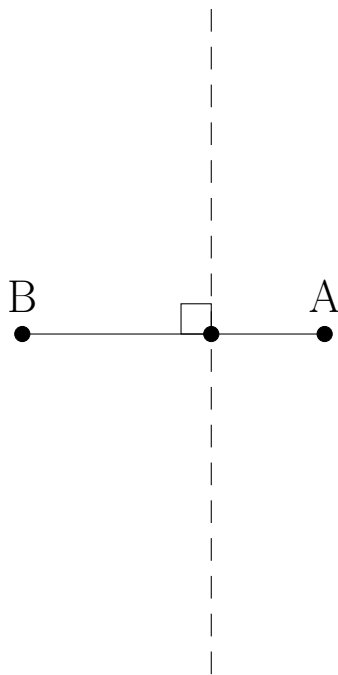

4.

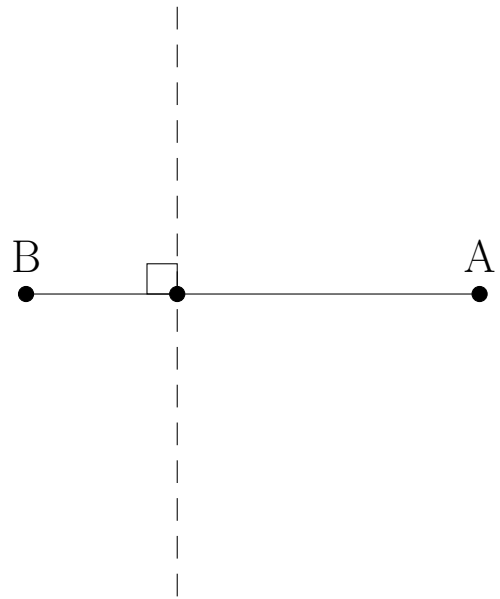

Rectas Perpendiculares (J)

Construya la recta perpendicular al segmento que pasa por el punto sin marcar.

1.

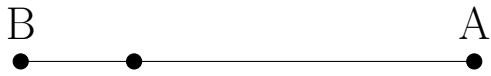

2.

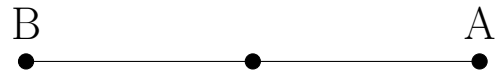

3.



4.



Rectas Perpendiculares (J) Respuestas

Construya la recta perpendicular al segmento que pasa por el punto sin marcar.

1.

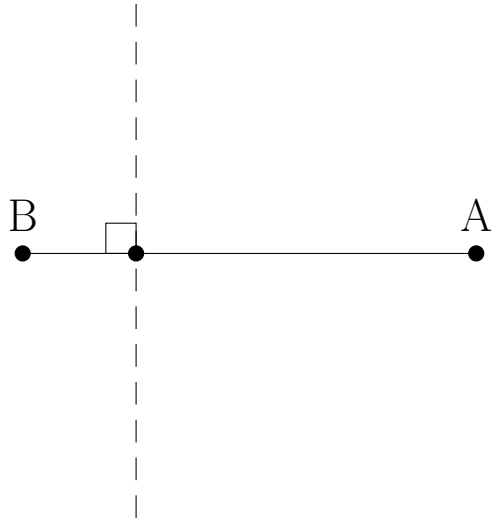

2.

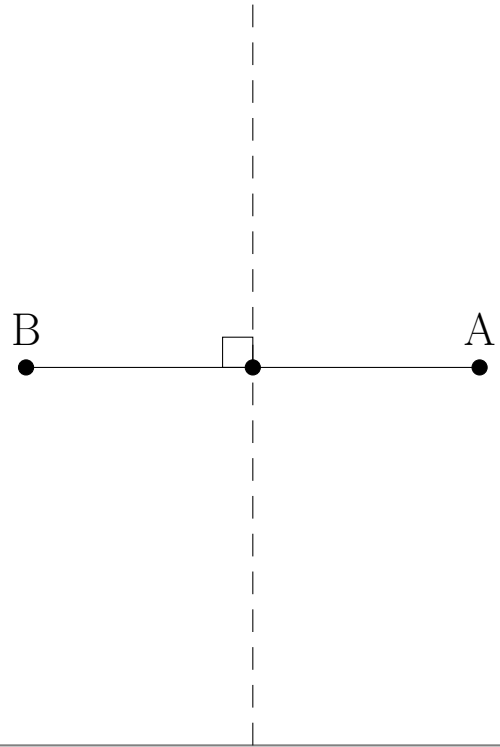

3.

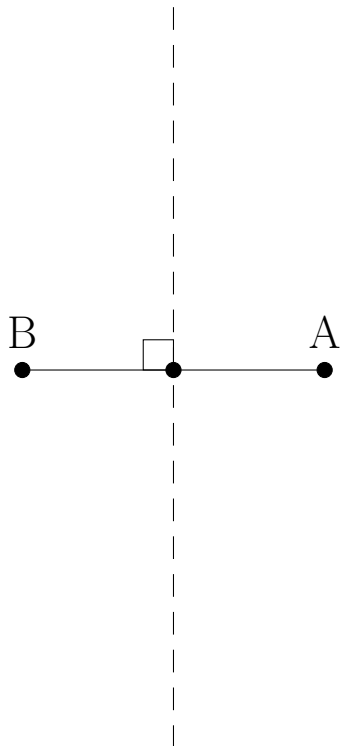

4.

