

# Rectas Perpendiculares (A)

Construya la recta perpendicular al segmento que pasa por el punto sin marcar.

1.



2.

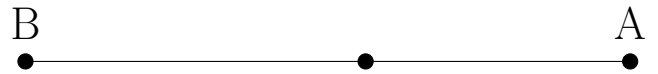

3.



4.

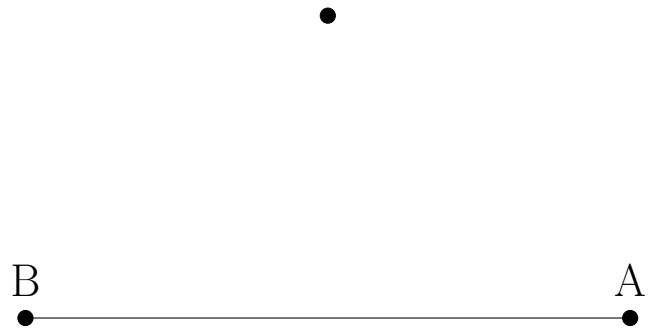

# Rectas Perpendiculares (A) Respuestas

Construya la recta perpendicular al segmento que pasa por el punto sin marcar.

1.

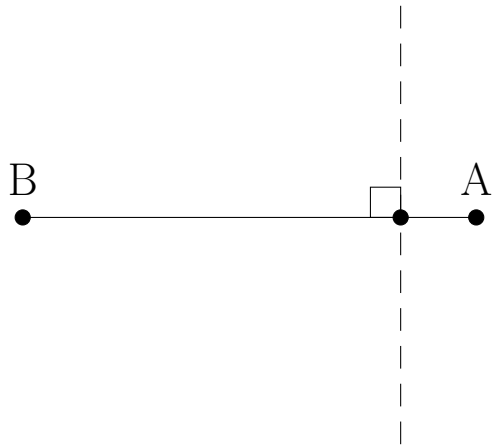

2.

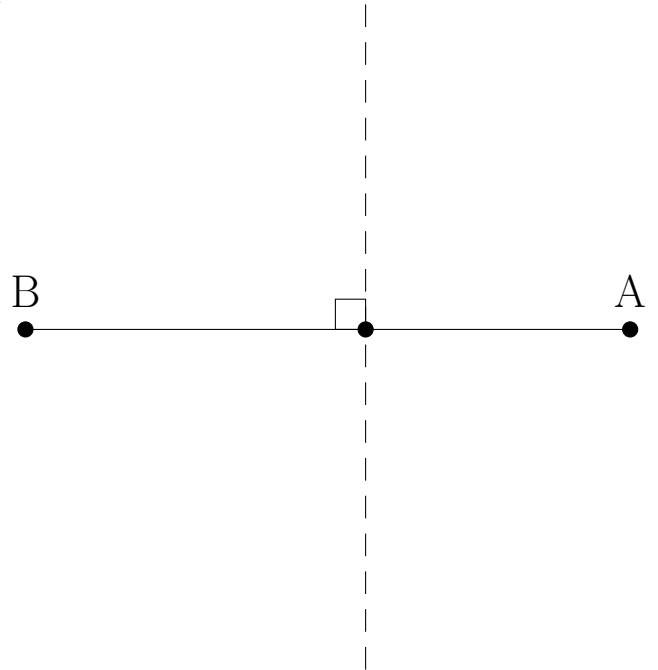

3.

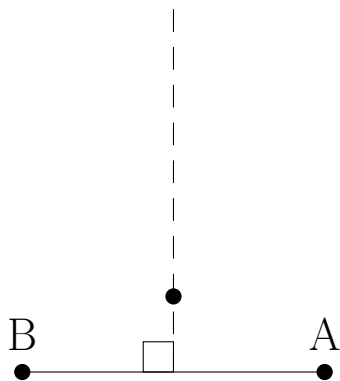

4.

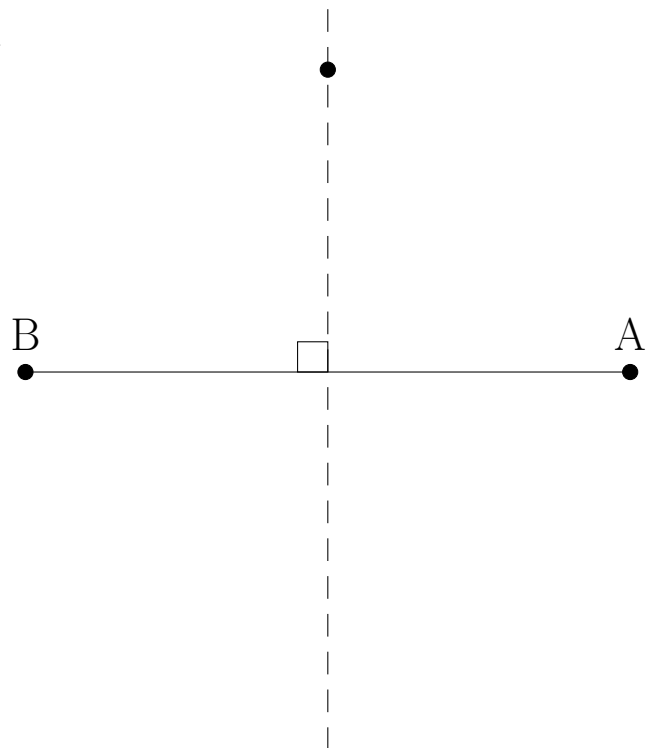

# Rectas Perpendiculares (B)

Construya la recta perpendicular al segmento que pasa por el punto sin marcar.

1.

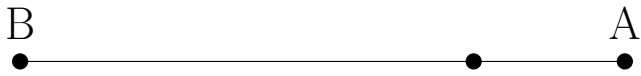

2.

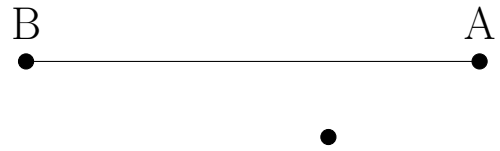

3.

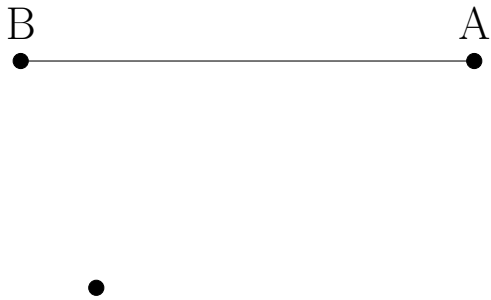

4.



## Rectas Perpendiculares (B) Respuestas

Construya la recta perpendicular al segmento que pasa por el punto sin marcar.

1.

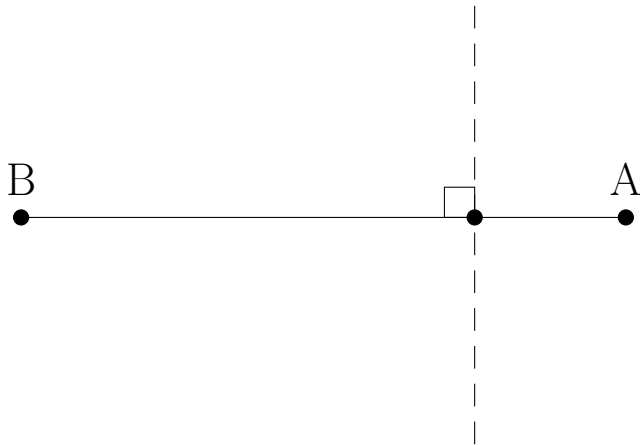

2.

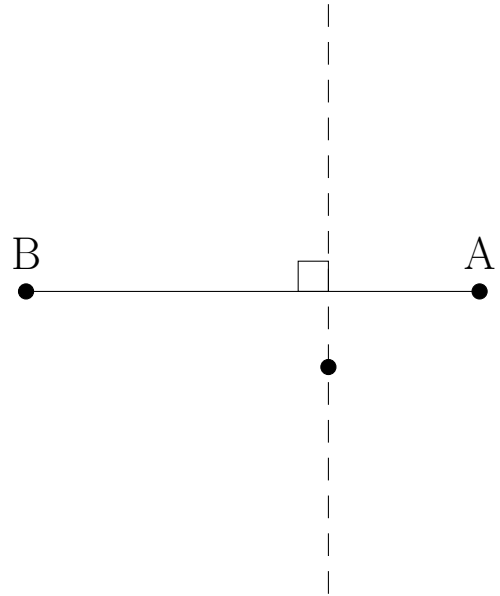

3.

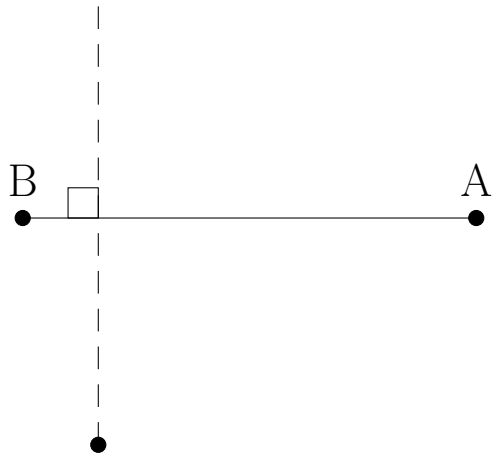

4.

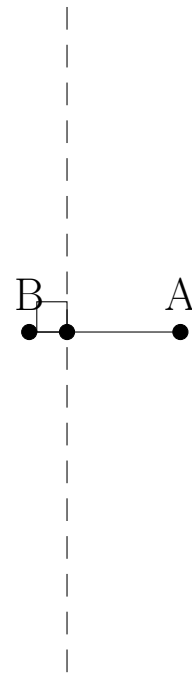

# Rectas Perpendiculares (C)

Construya la recta perpendicular al segmento que pasa por el punto sin marcar.

1.



2.

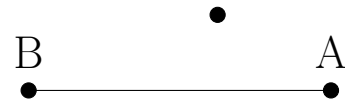

3.



4.



# Rectas Perpendiculares (C) Respuestas

Construya la recta perpendicular al segmento que pasa por el punto sin marcar.

1.

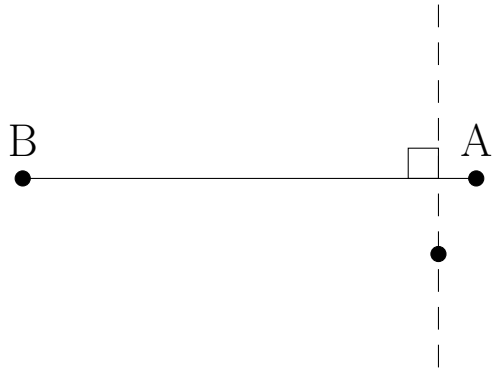

2.

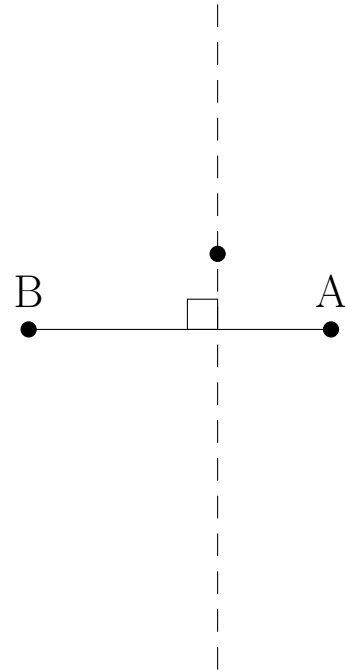

3.

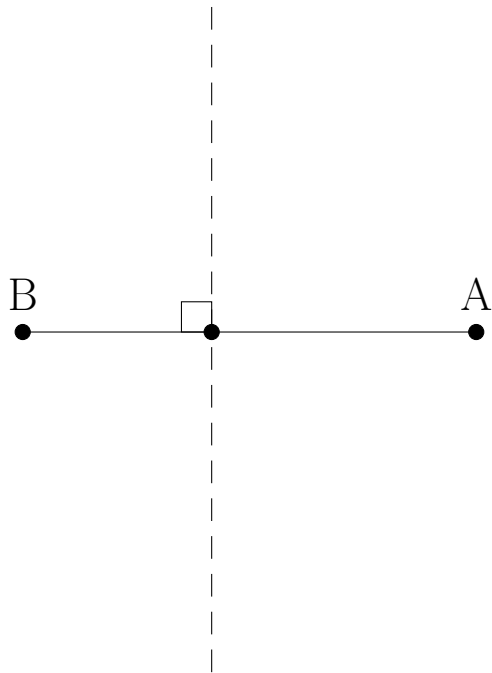

4.

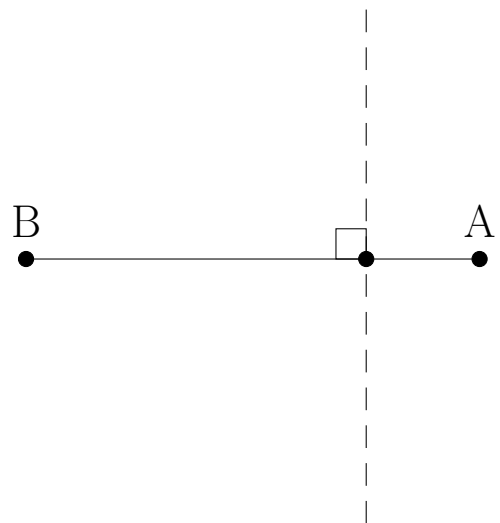

# Rectas Perpendiculares (D)

Construya la recta perpendicular al segmento que pasa por el punto sin marcar.

1.



2.

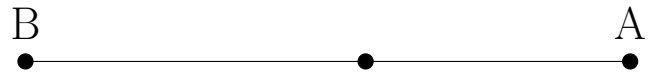

3.



4.



# Rectas Perpendiculares (D) Respuestas

Construya la recta perpendicular al segmento que pasa por el punto sin marcar.

1.

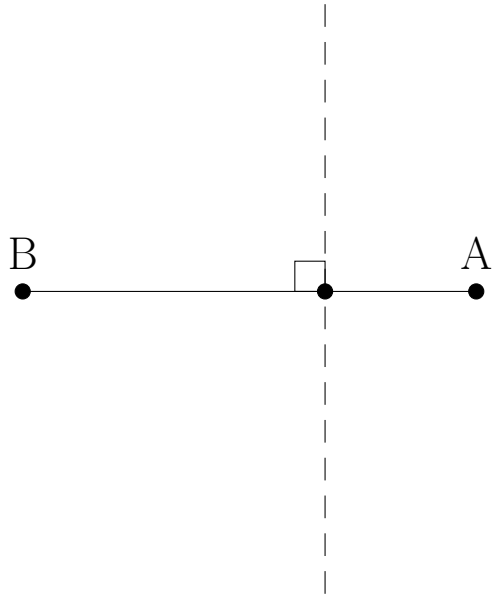

2.

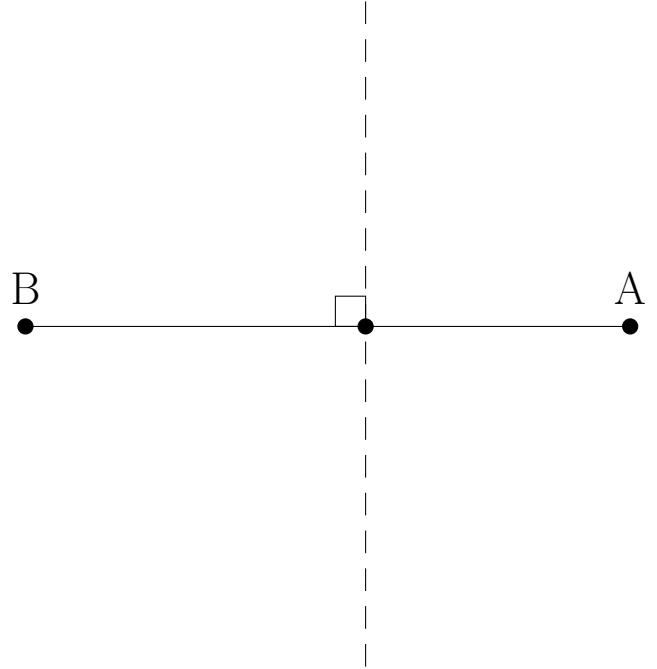

3.



4.

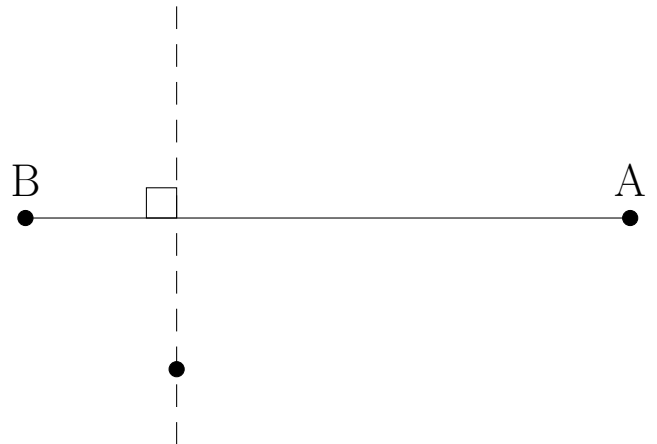



# Rectas Perpendiculares (E)

Construya la recta perpendicular al segmento que pasa por el punto sin marcar.

1.

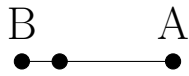

2.



3.

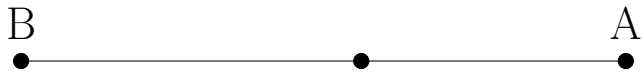

4.



# Rectas Perpendiculares (E) Respuestas

Construya la recta perpendicular al segmento que pasa por el punto sin marcar.

1.

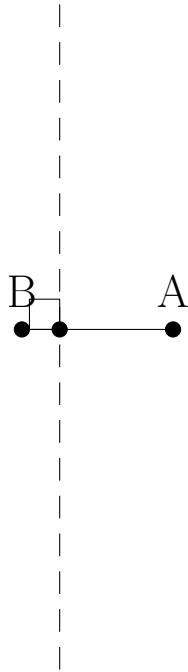

2.



3.

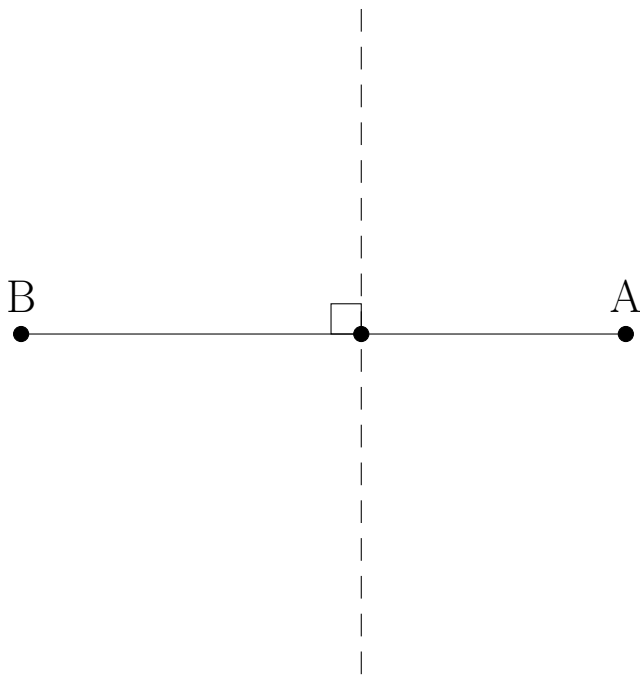

4.

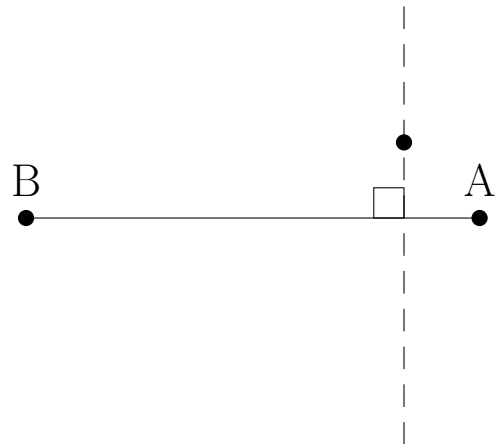

# Rectas Perpendiculares (F)

Construya la recta perpendicular al segmento que pasa por el punto sin marcar.

1.



2.

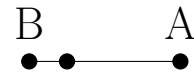

3.



4.



# Rectas Perpendiculares (F) Respuestas

Construya la recta perpendicular al segmento que pasa por el punto sin marcar.

1.

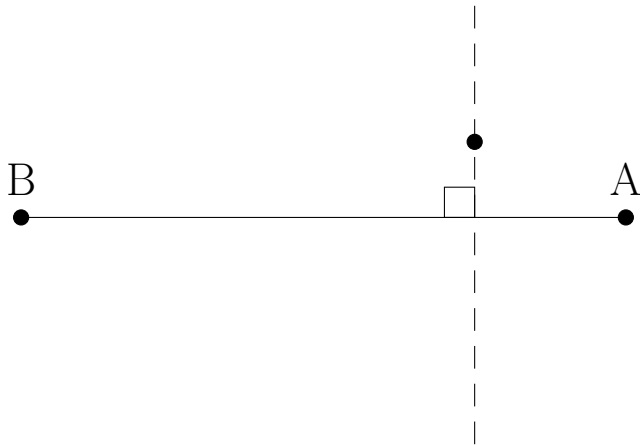

2.

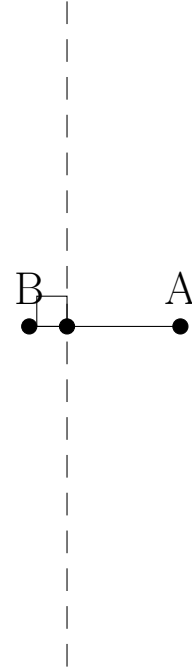

3.

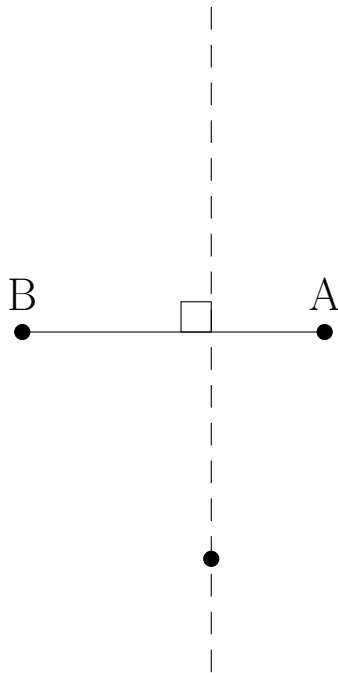

4.

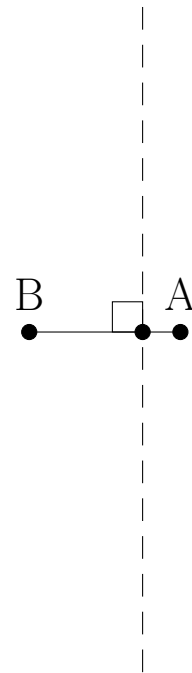

# Rectas Perpendiculares (G)

Construya la recta perpendicular al segmento que pasa por el punto sin marcar.

1.

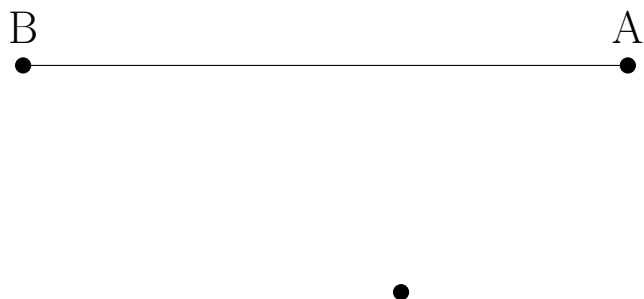

2.



3.

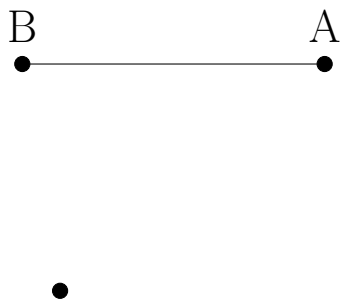

4.



# Rectas Perpendiculares (G) Respuestas

Construya la recta perpendicular al segmento que pasa por el punto sin marcar.

1.

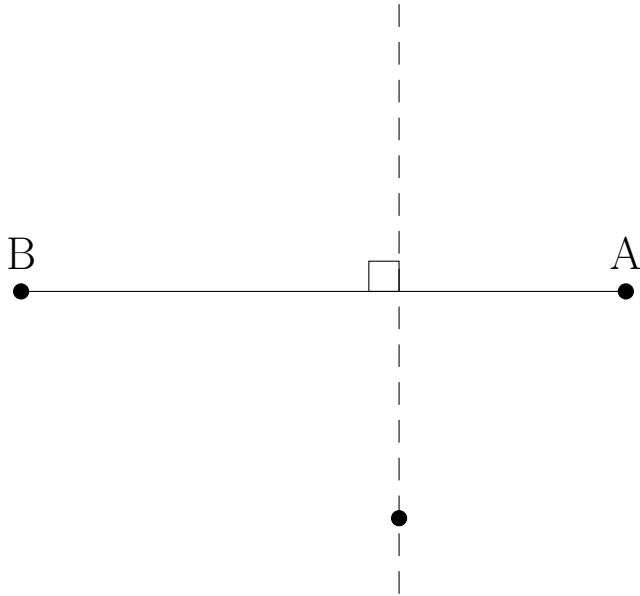

2.

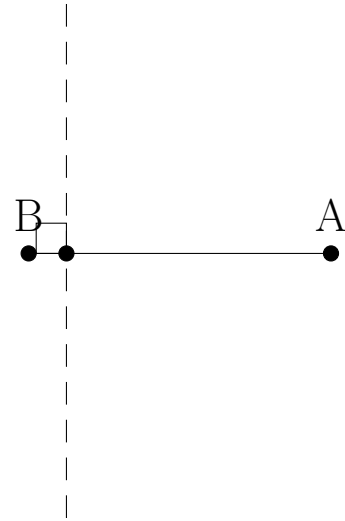

3.

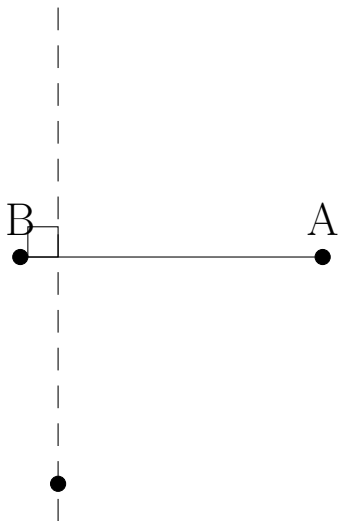

4.

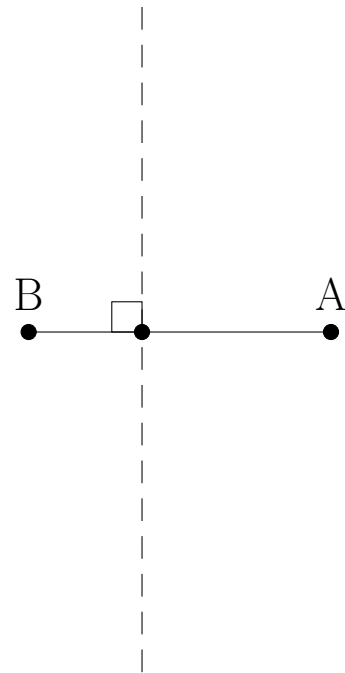

# Rectas Perpendiculares (H)

Construya la recta perpendicular al segmento que pasa por el punto sin marcar.

1.



2.



3.



4.



# Rectas Perpendiculares (H) Respuestas

Construya la recta perpendicular al segmento que pasa por el punto sin marcar.

1.

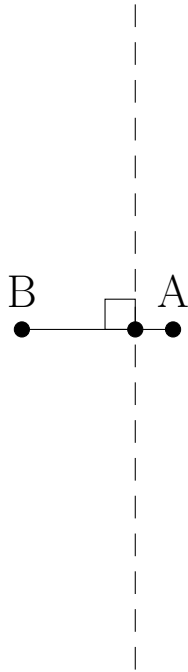

2.

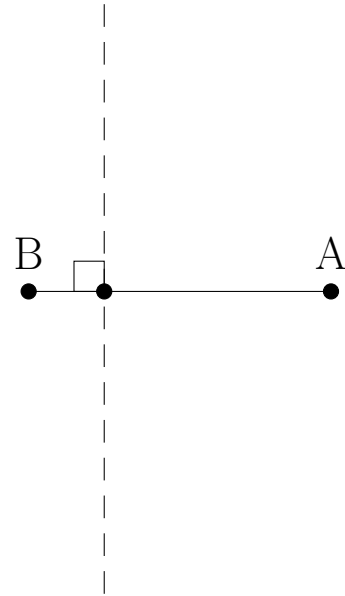

3.

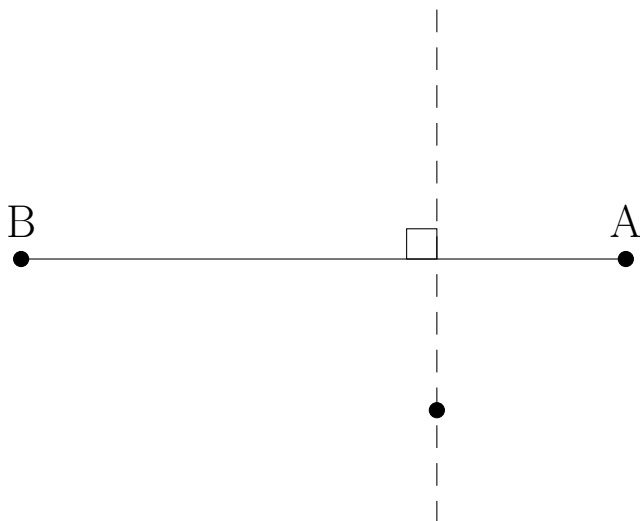

4.

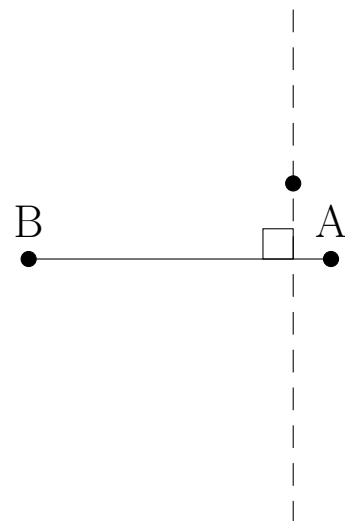



# Rectas Perpendiculares (I)

Construya la recta perpendicular al segmento que pasa por el punto sin marcar.

1.

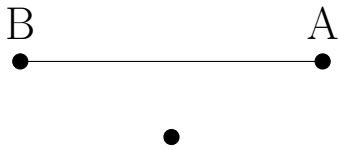

2.

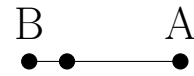

3.

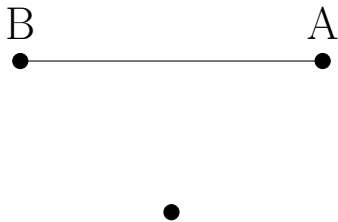

4.



# Rectas Perpendiculares (I) Respuestas

Construya la recta perpendicular al segmento que pasa por el punto sin marcar.

1.

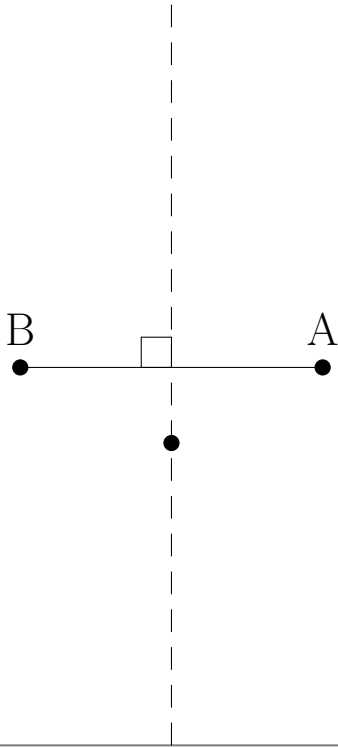

2.

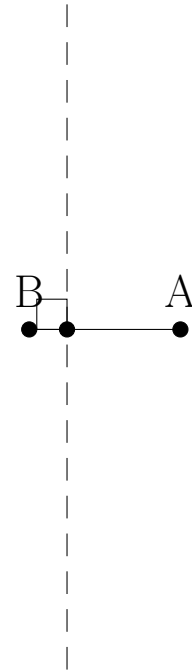

3.

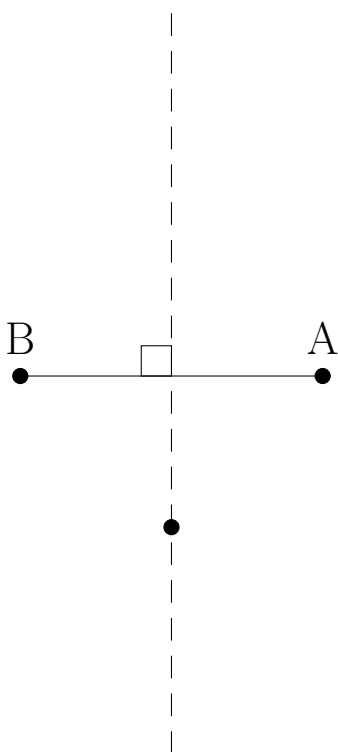

4.

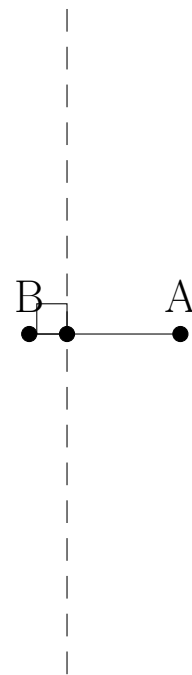

# Rectas Perpendiculares (J)

Construya la recta perpendicular al segmento que pasa por el punto sin marcar.

1.



2.



3.



4.



# Rectas Perpendiculares (J) Respuestas

Construya la recta perpendicular al segmento que pasa por el punto sin marcar.

1.

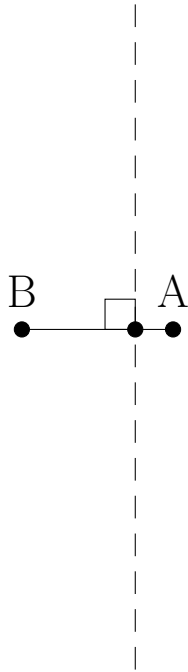

2.



3.

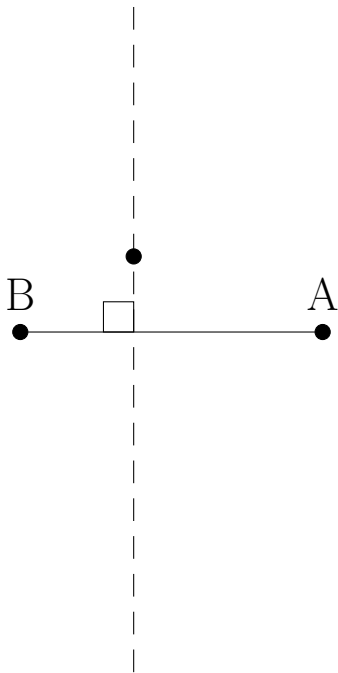

4.

