

Factor de Escala (A)

Name: _____

Date: _____

Determine el factor de escala para cada par de formas y marque las longitudes que faltan.

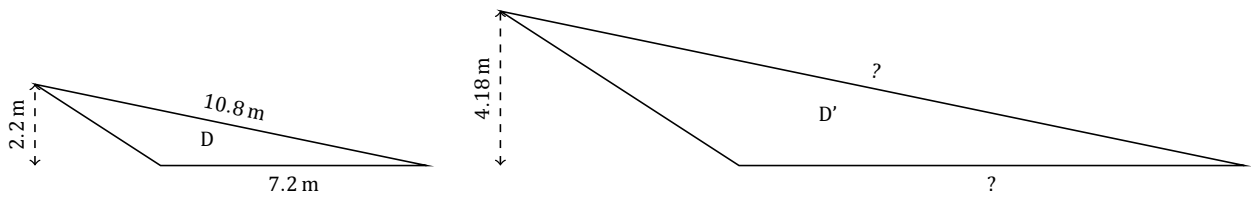
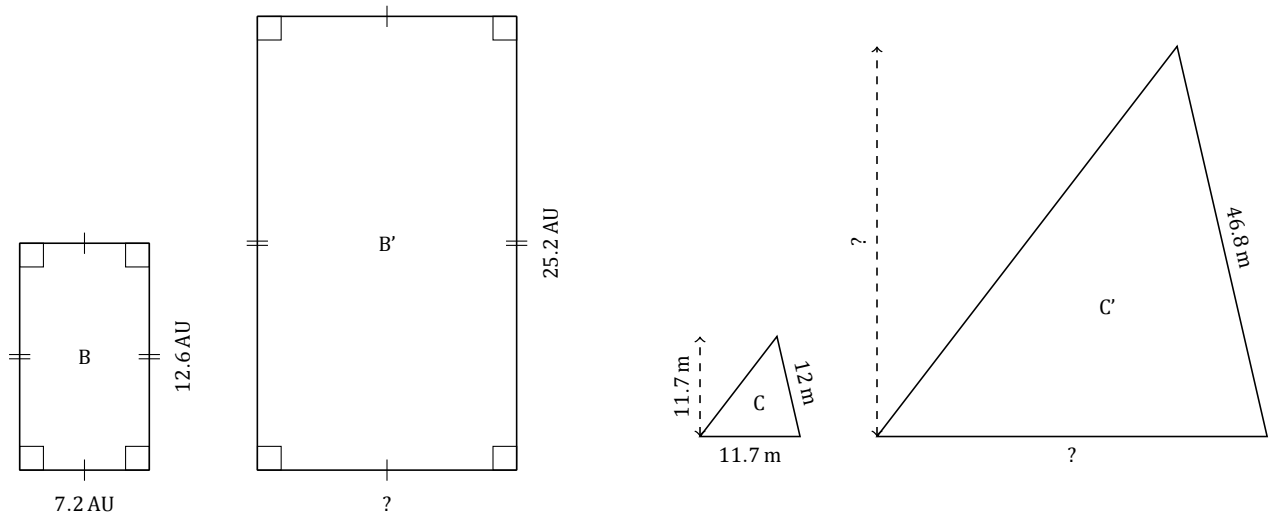
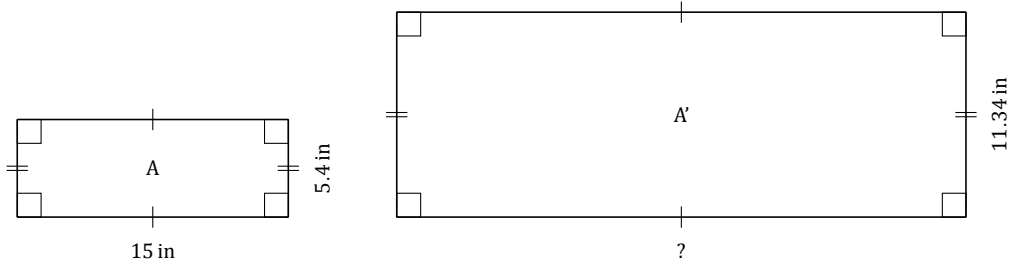

Factor de Escala (A) Respuestas

Name: _____

Date: _____

Determine el factor de escala para cada par de formas y marque las longitudes que faltan.

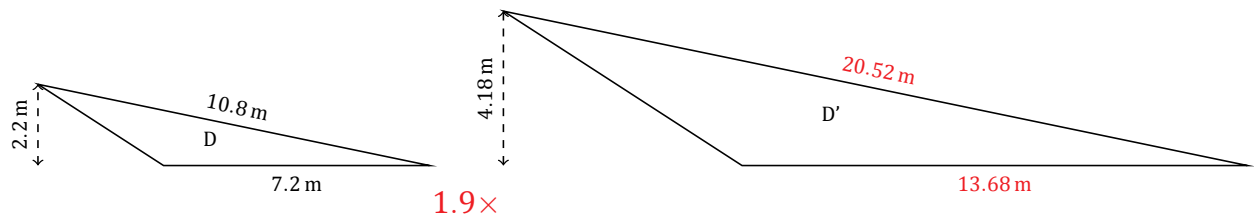
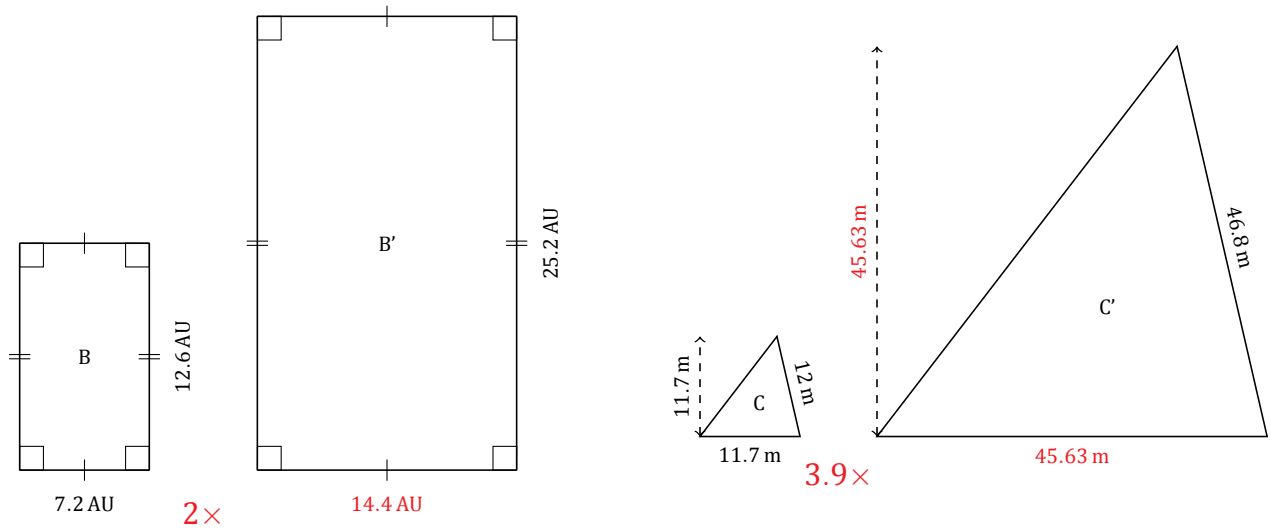
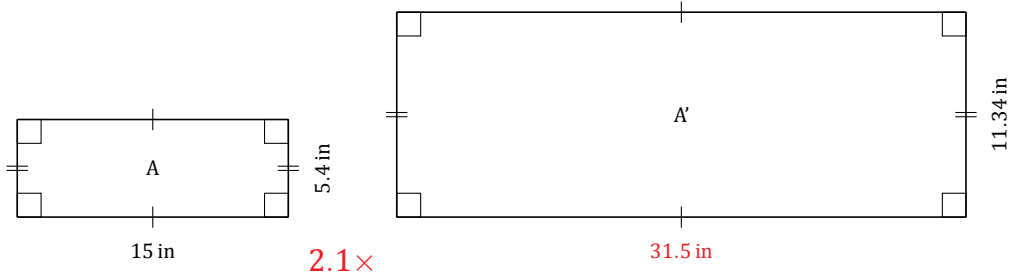

Factor de Escala (B)

Name: _____

Date: _____

Determine el factor de escala para cada par de formas y marque las longitudes que faltan.

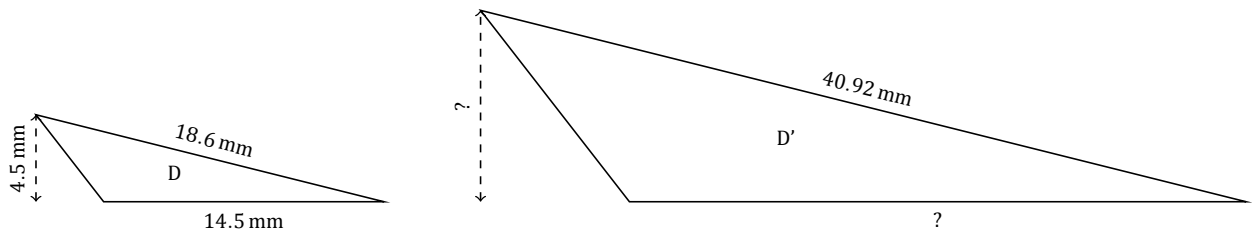
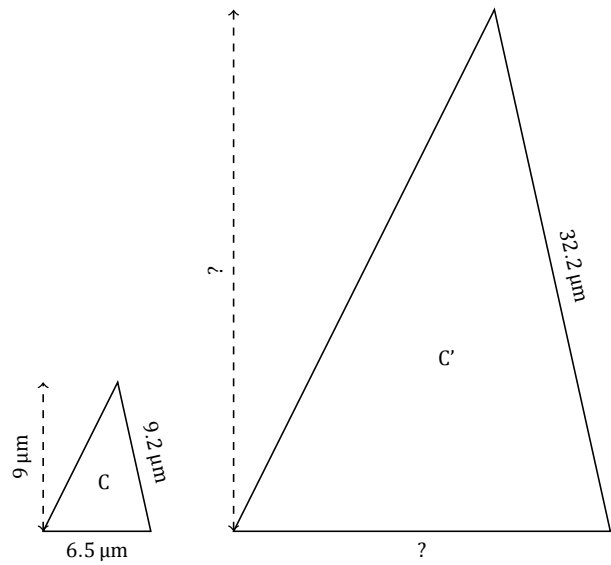
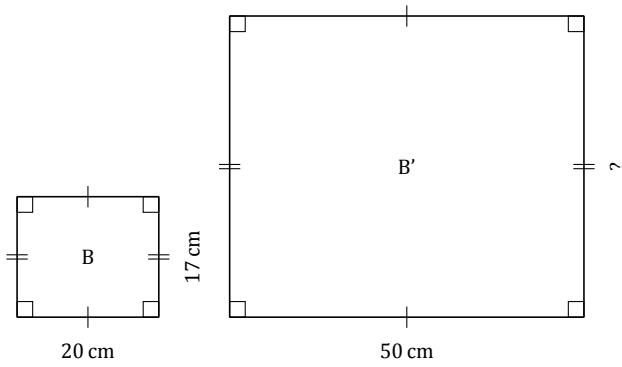
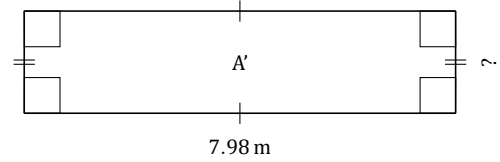
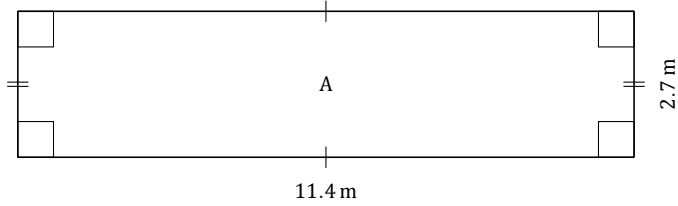

Factor de Escala (B) Respuestas

Name: _____

Date: _____

Determine el factor de escala para cada par de formas y marque las longitudes que faltan.

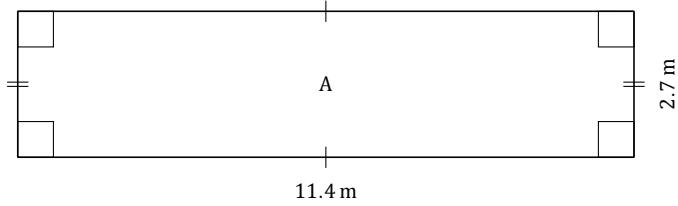

0.7×

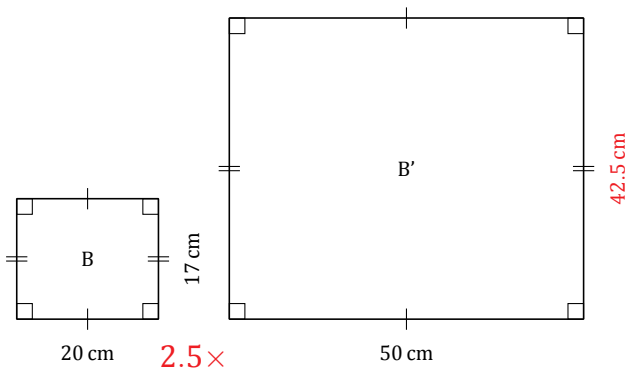
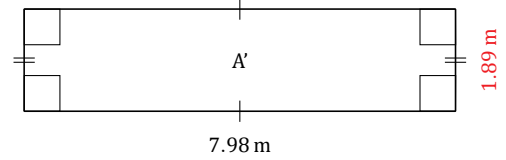

2.5×

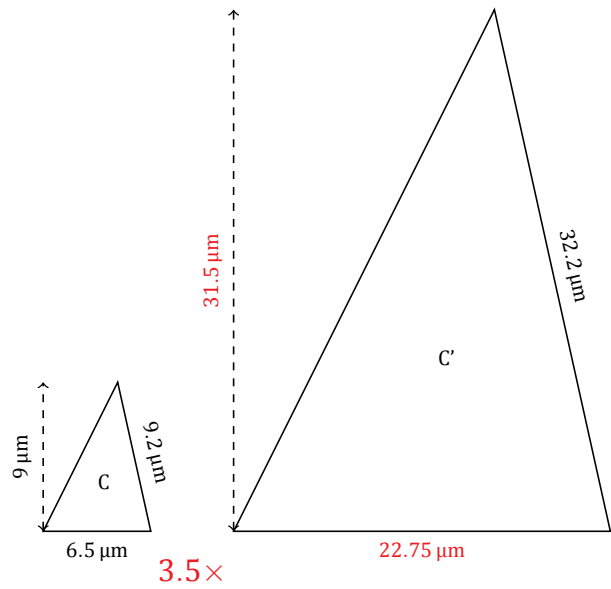
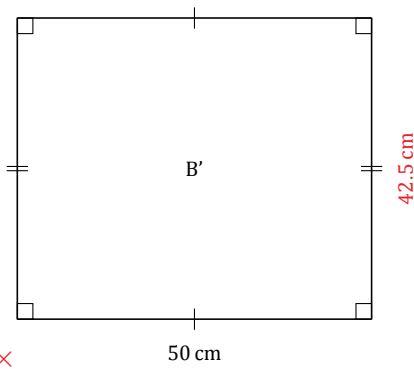

3.5×

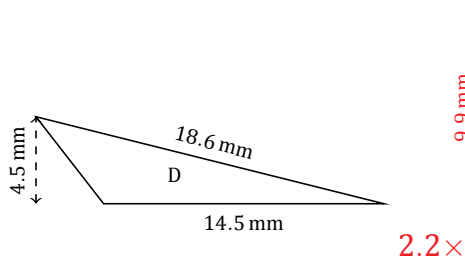
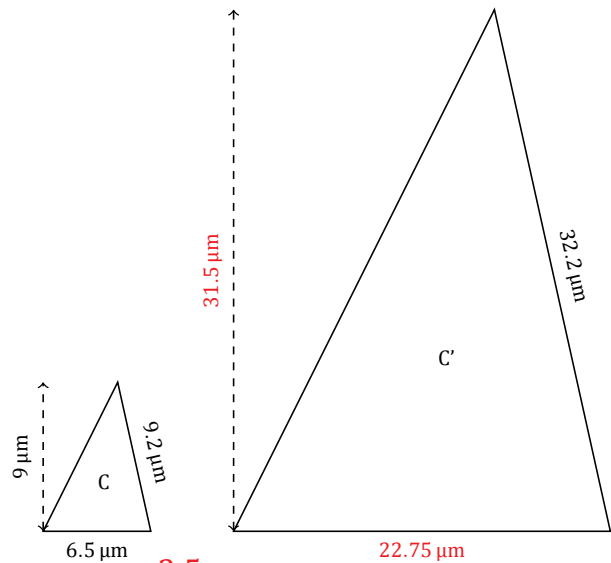

2.2×

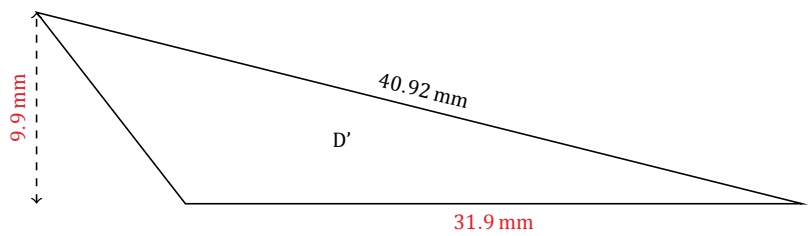

Factor de Escala (C)

Name: _____

Date: _____

Determine el factor de escala para cada par de formas y marque las longitudes que faltan.

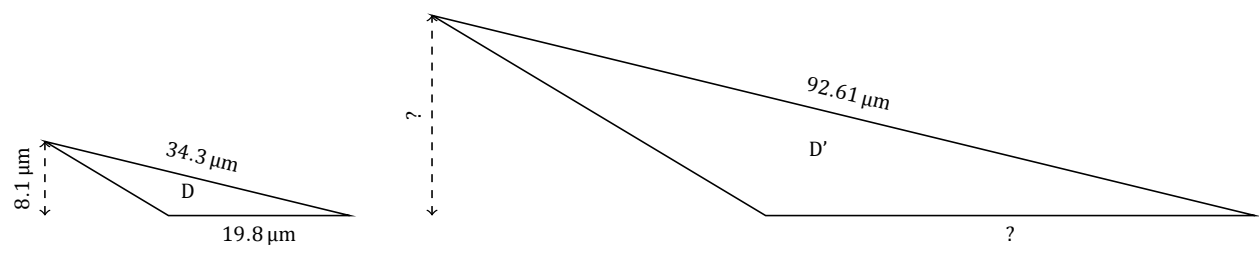
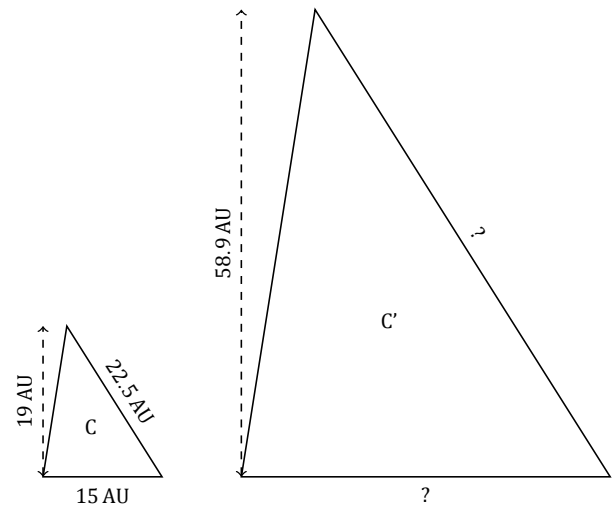
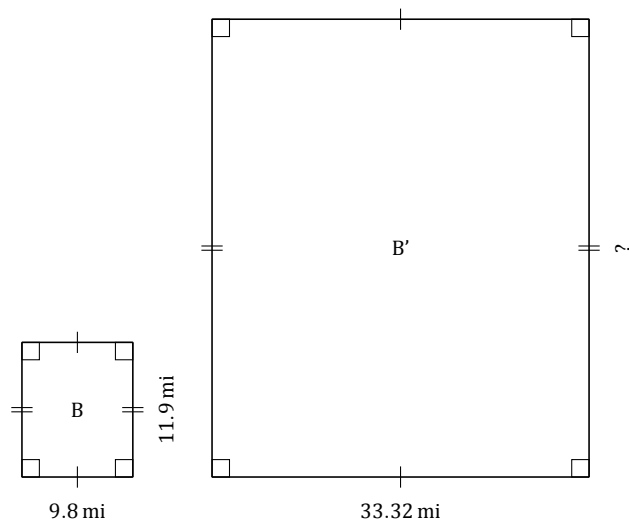
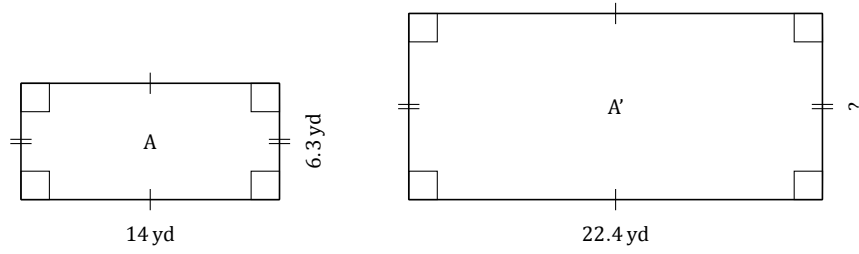

Factor de Escala (C) Respuestas

Name: _____

Date: _____

Determine el factor de escala para cada par de formas y marque las longitudes que faltan.

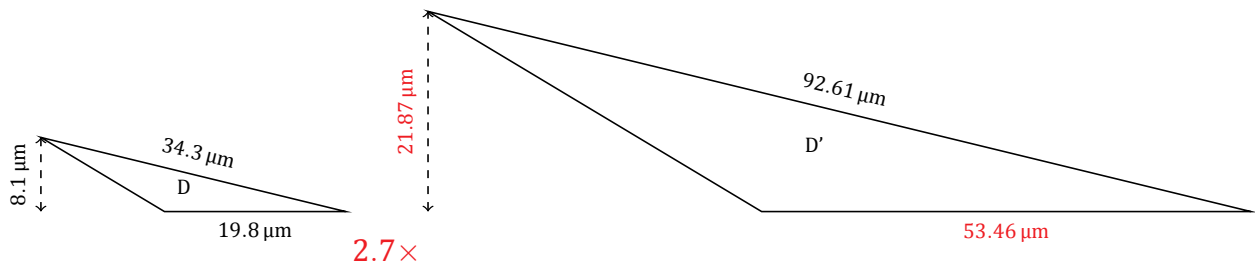
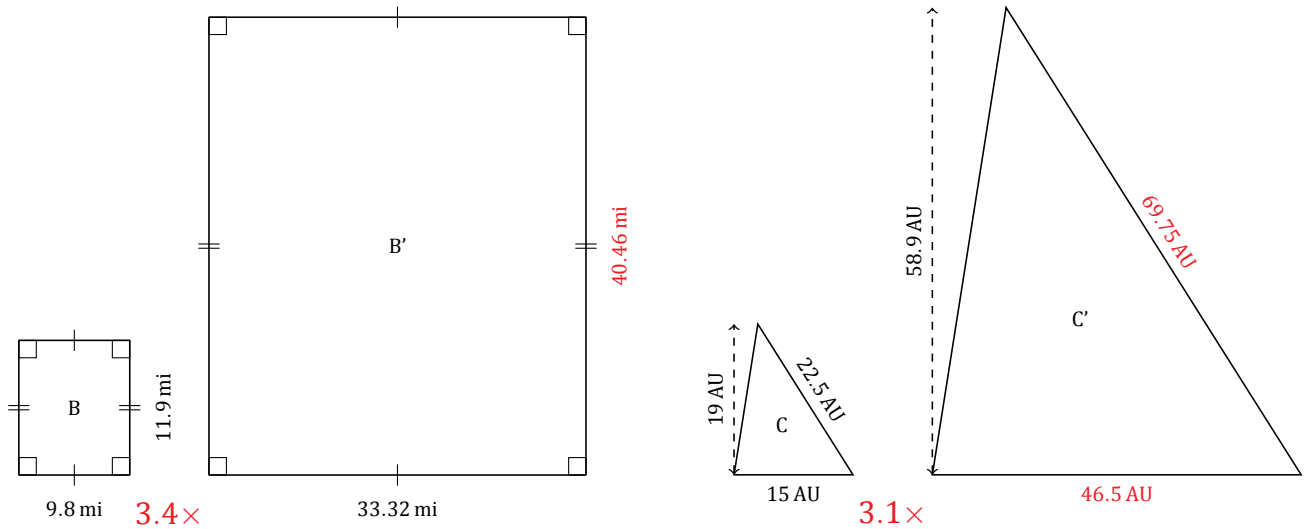
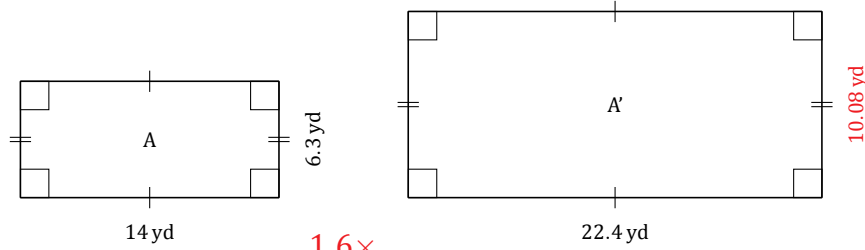

Factor de Escala (D)

Name: _____

Date: _____

Determine el factor de escala para cada par de formas y marque las longitudes que faltan.

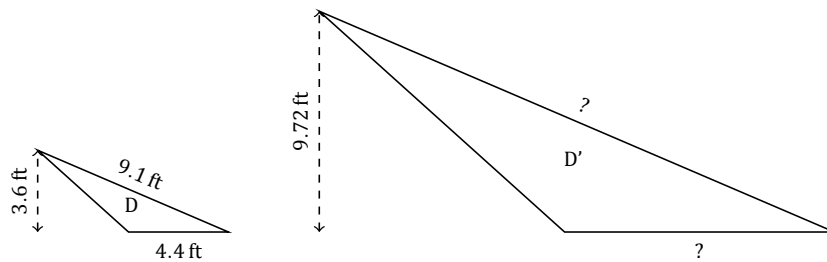
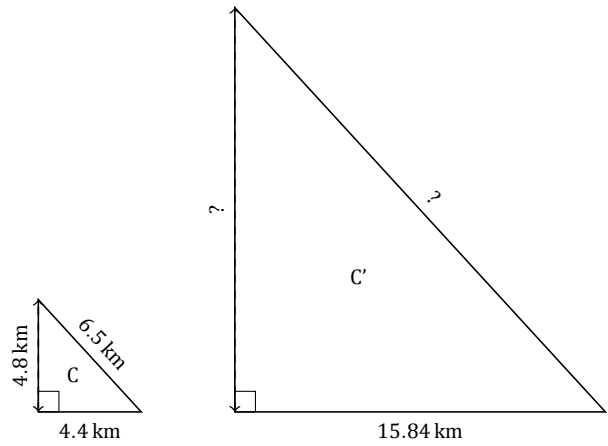
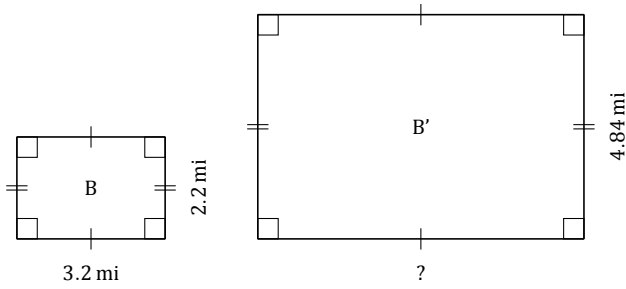
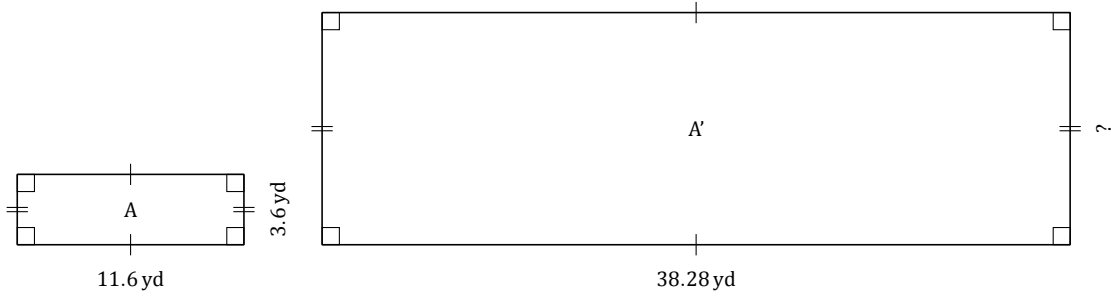

Factor de Escala (D) Respuestas

Name: _____

Date: _____

Determine el factor de escala para cada par de formas y marque las longitudes que faltan.

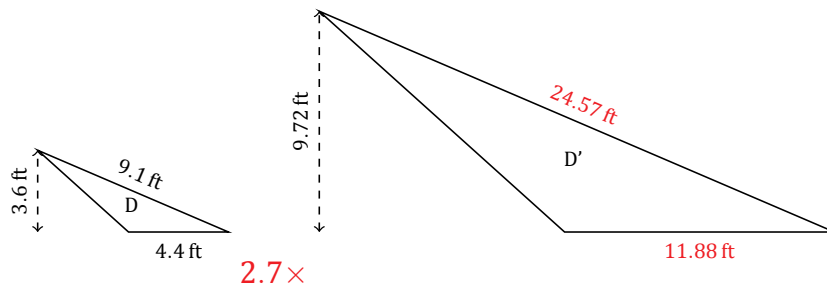
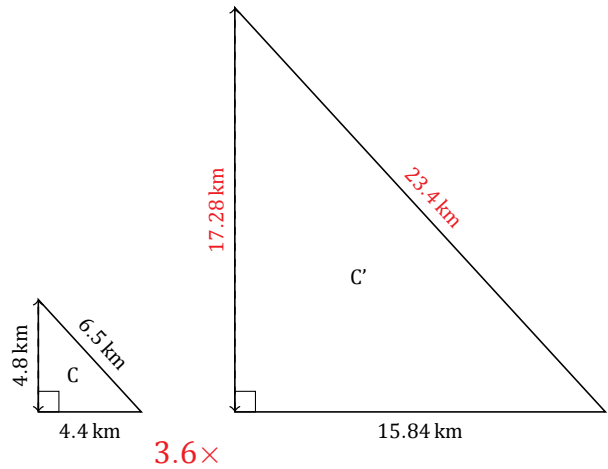
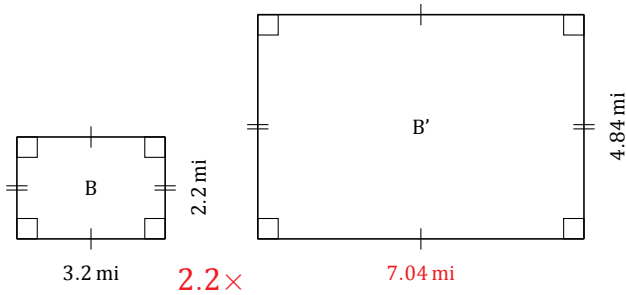
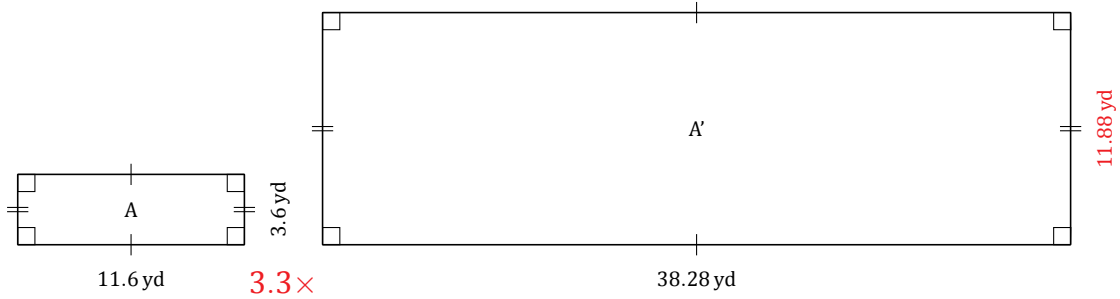

Factor de Escala (E)

Name: _____

Date: _____

Determine el factor de escala para cada par de formas y marque las longitudes que faltan.

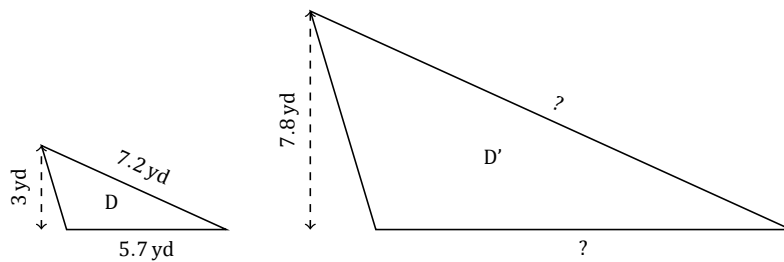
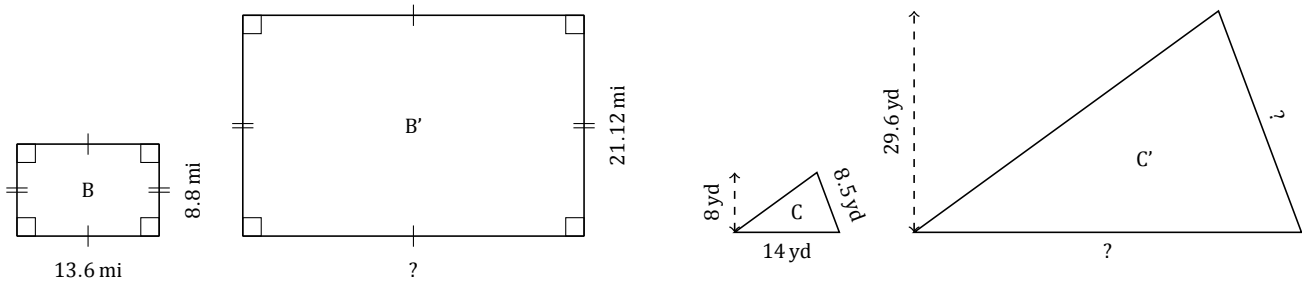
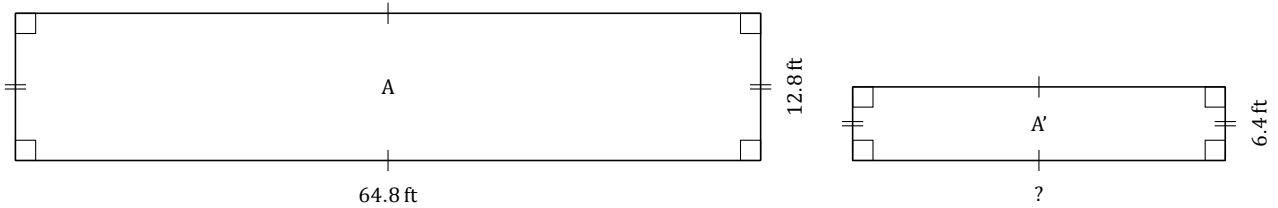

Factor de Escala (E) Respuestas

Name: _____

Date: _____

Determine el factor de escala para cada par de formas y marque las longitudes que faltan.

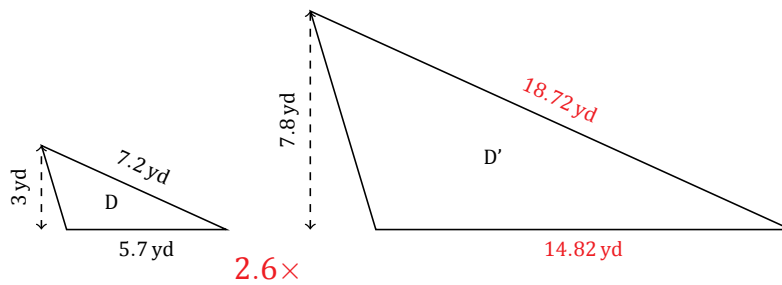
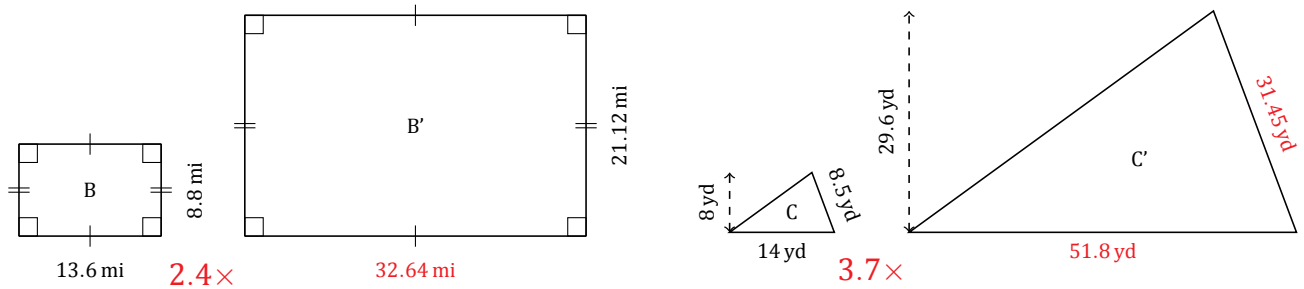
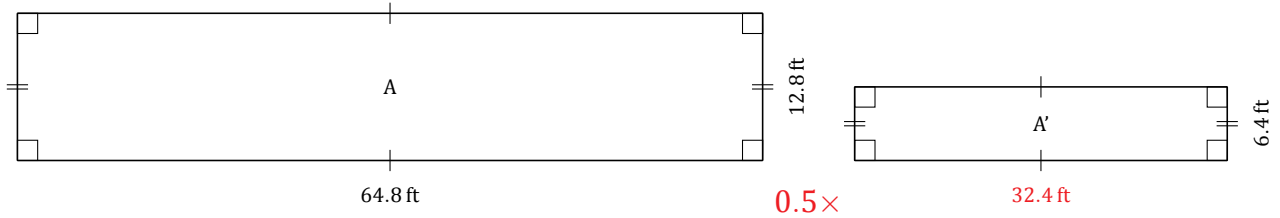

Factor de Escala (F)

Name: _____

Date: _____

Determine el factor de escala para cada par de formas y marque las longitudes que faltan.

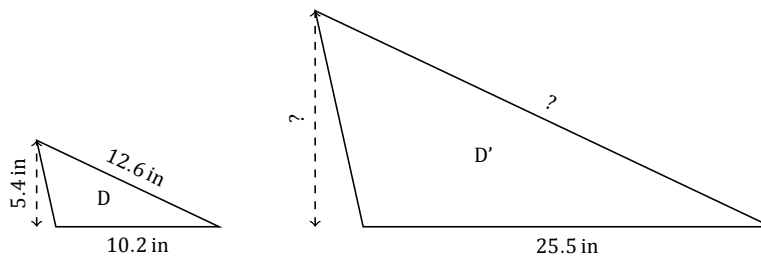
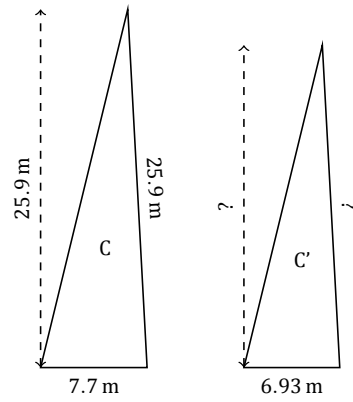
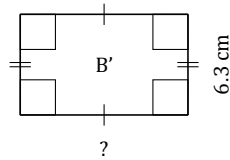
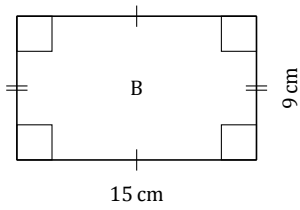
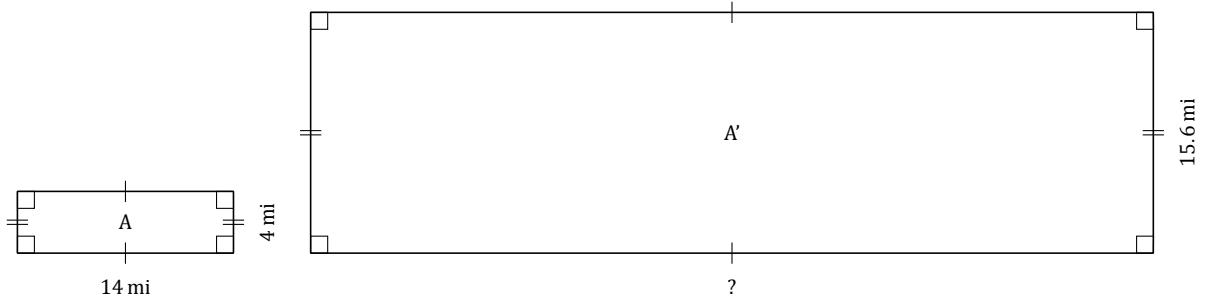

Factor de Escala (F) Respuestas

Name: _____

Date: _____

Determine el factor de escala para cada par de formas y marque las longitudes que faltan.

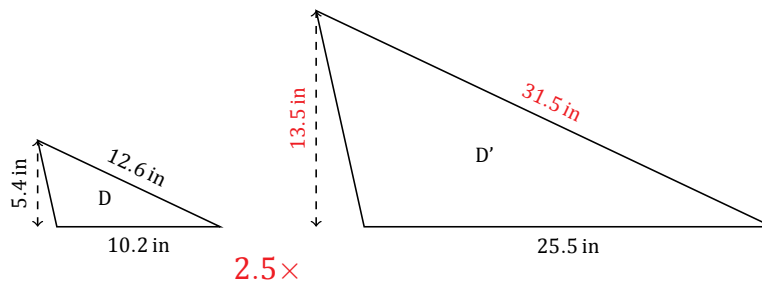
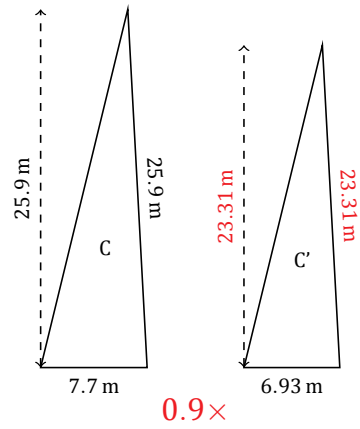
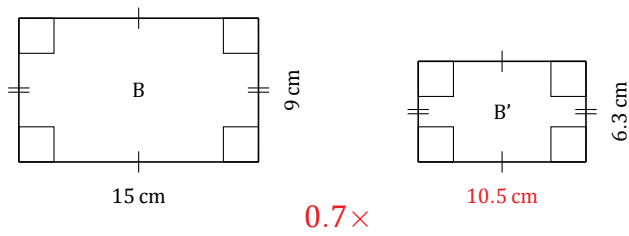
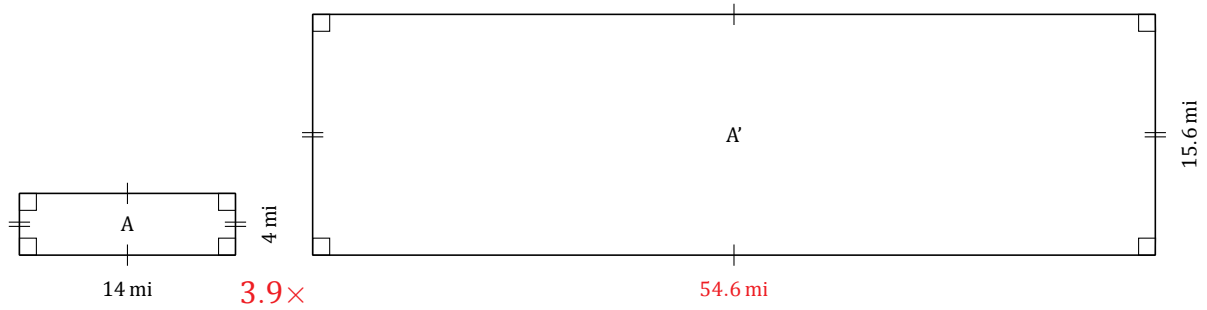

Factor de Escala (G)

Name: _____

Date: _____

Determine el factor de escala para cada par de formas y marque las longitudes que faltan.

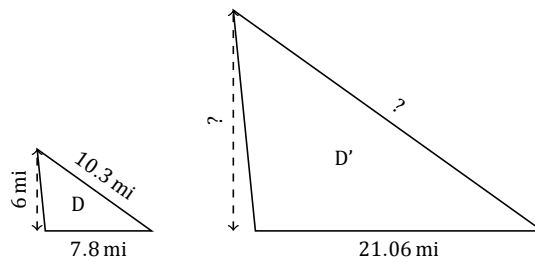
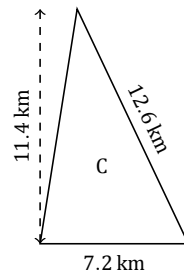
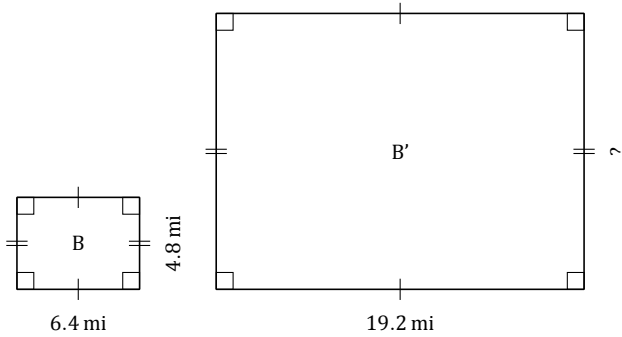
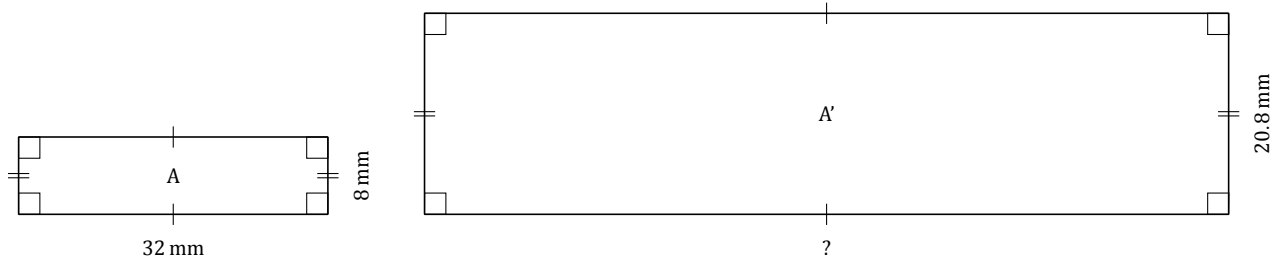

Factor de Escala (G) Respuestas

Name: _____

Date: _____

Determine el factor de escala para cada par de formas y marque las longitudes que faltan.

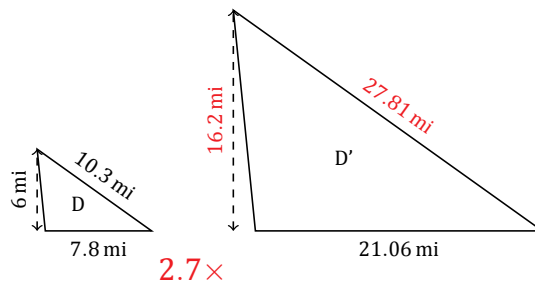
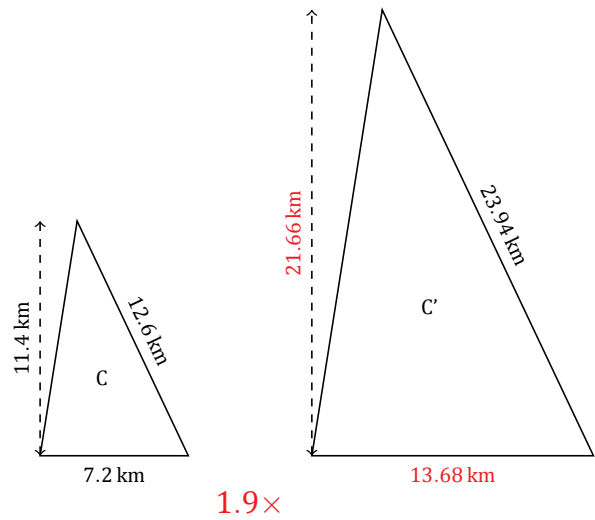
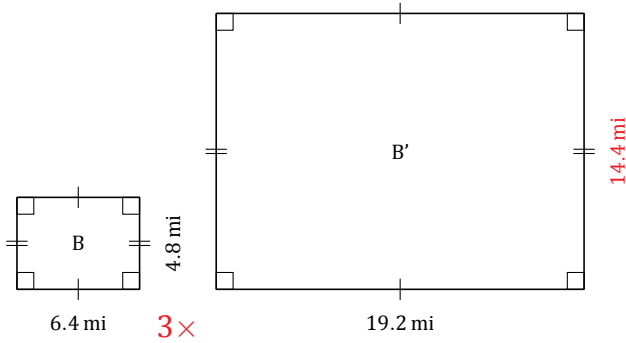
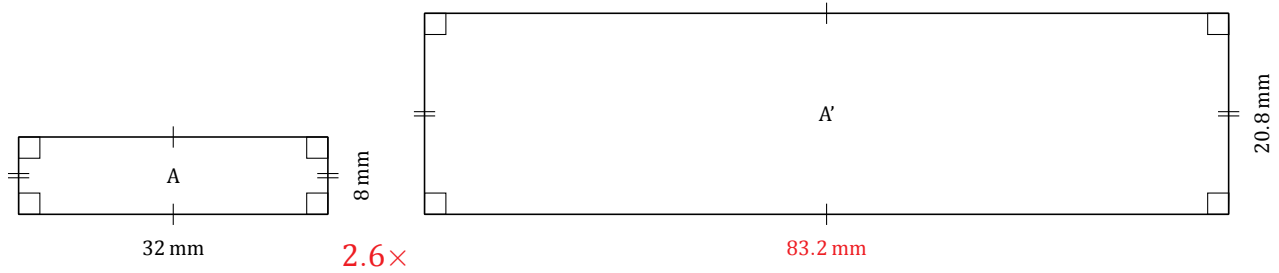

Factor de Escala (H)

Name: _____

Date: _____

Determine el factor de escala para cada par de formas y marque las longitudes que faltan.

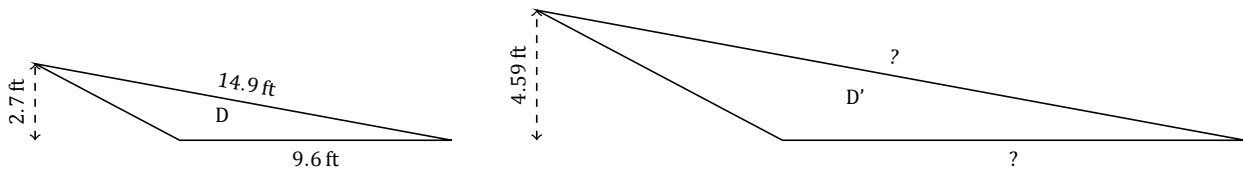
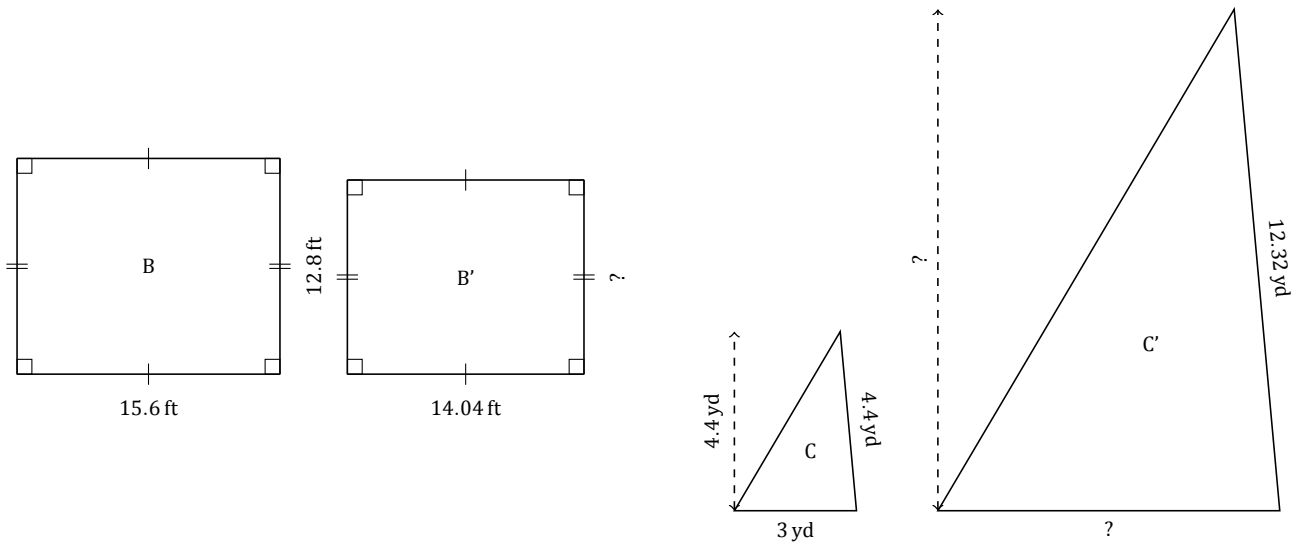

Factor de Escala (H) Respuestas

Name: _____

Date: _____

Determine el factor de escala para cada par de formas y marque las longitudes que faltan.

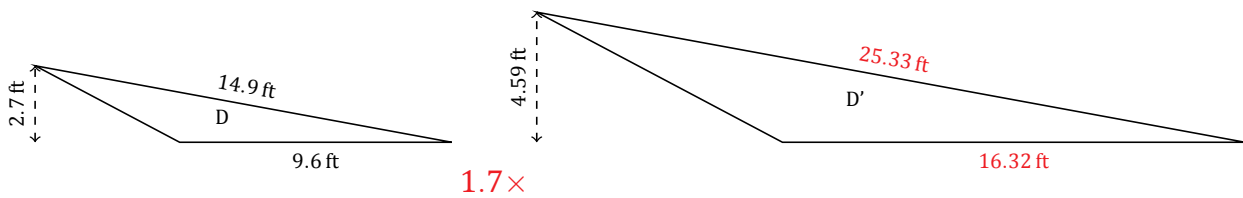
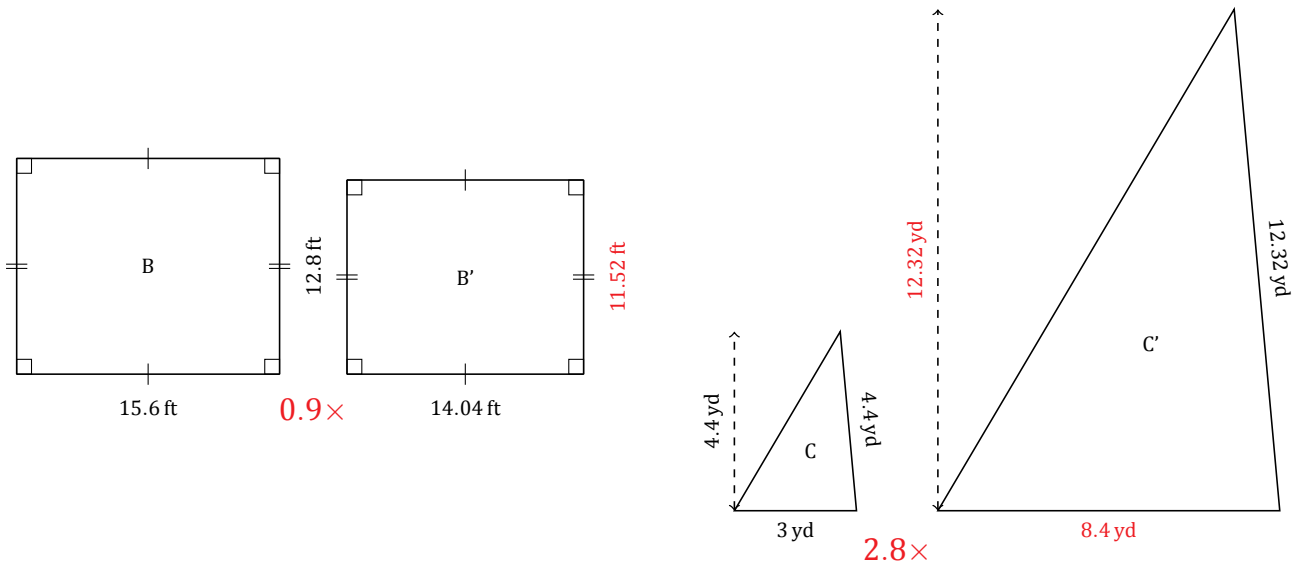
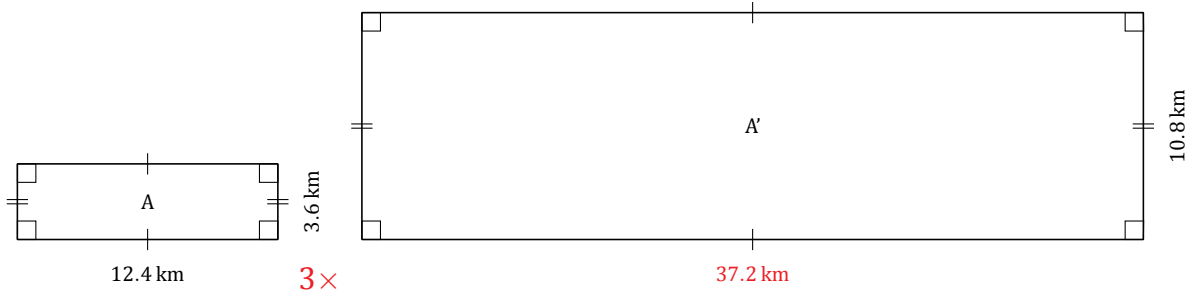

Factor de Escala (I)

Name: _____

Date: _____

Determine el factor de escala para cada par de formas y marque las longitudes que faltan.

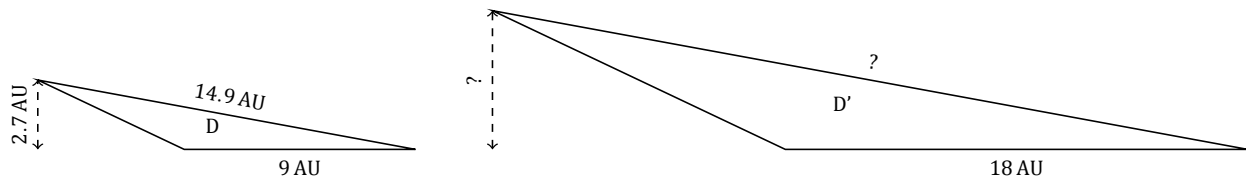
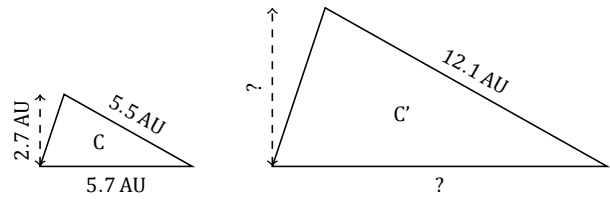
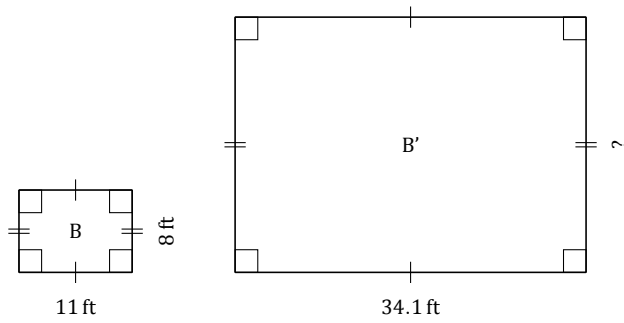
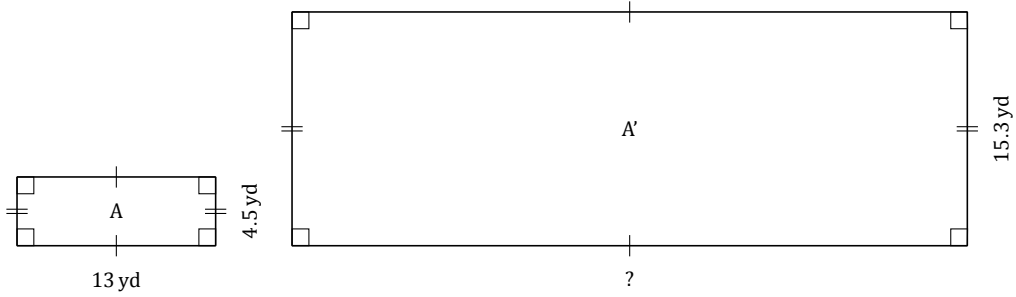

Factor de Escala (I) Respuestas

Name: _____

Date: _____

Determine el factor de escala para cada par de formas y marque las longitudes que faltan.

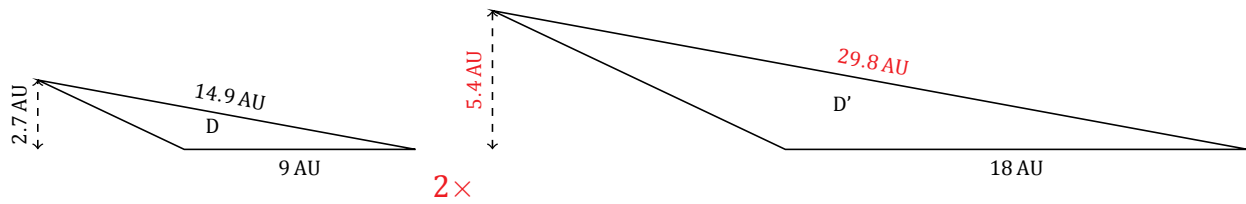
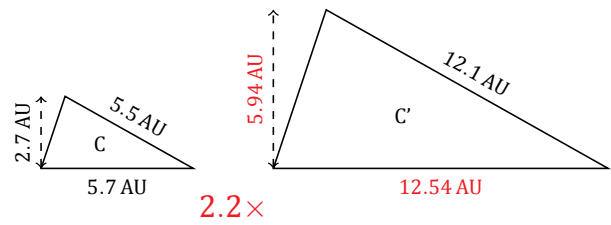
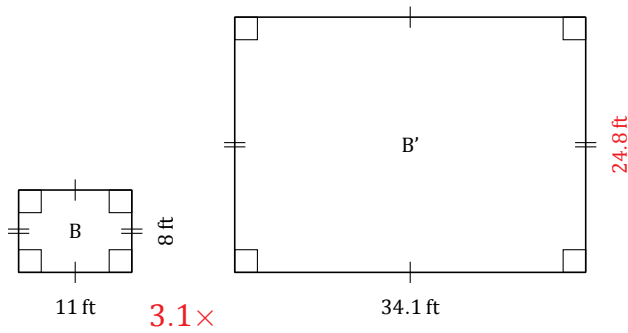
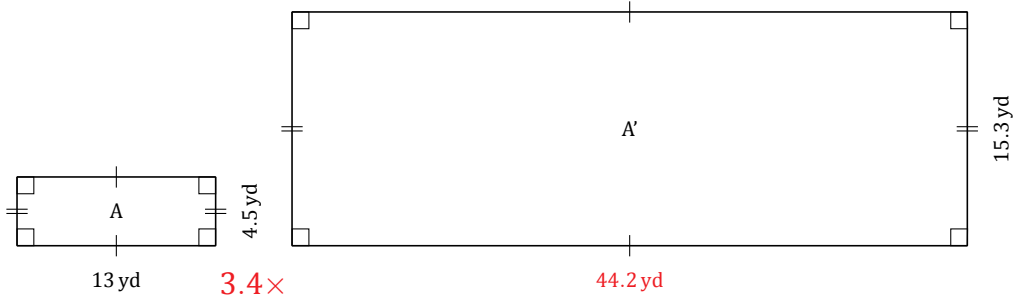

Factor de Escala (J)

Name: _____

Date: _____

Determine el factor de escala para cada par de formas y marque las longitudes que faltan.

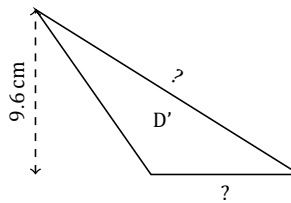
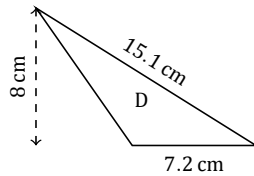
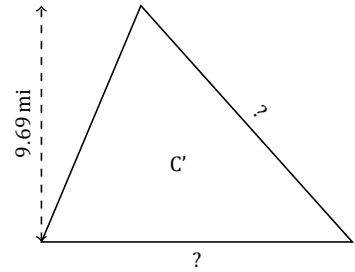
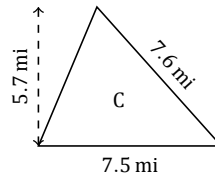
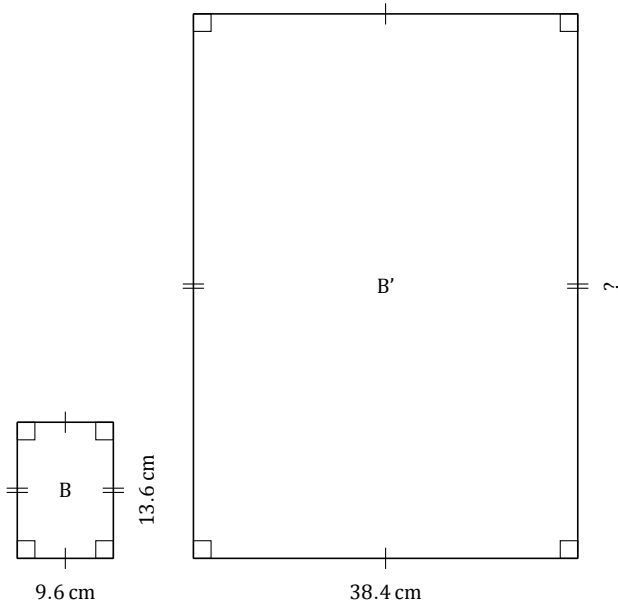
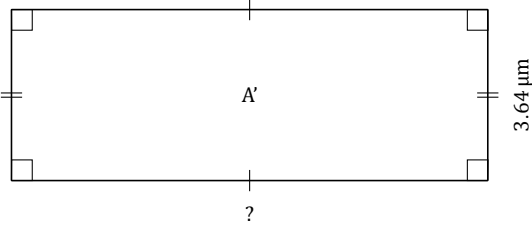
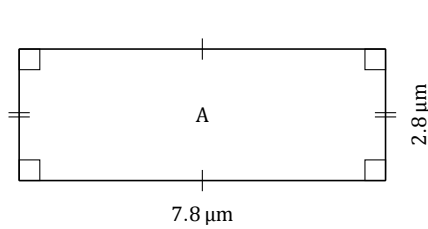

Factor de Escala (J) Respuestas

Name: _____

Date: _____

Determine el factor de escala para cada par de formas y marque las longitudes que faltan.

