

# Reflexiones (A)

Dibuje cada figura reflejada.

Refleje en  $x = 4$ .  
Refleje en  $y = -4$ .

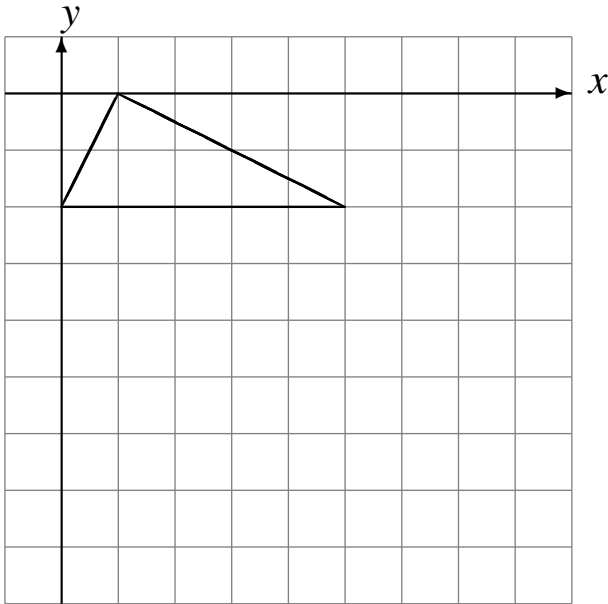

Refleje en  $x = -4$ .  
Refleje en  $x = -2$ .

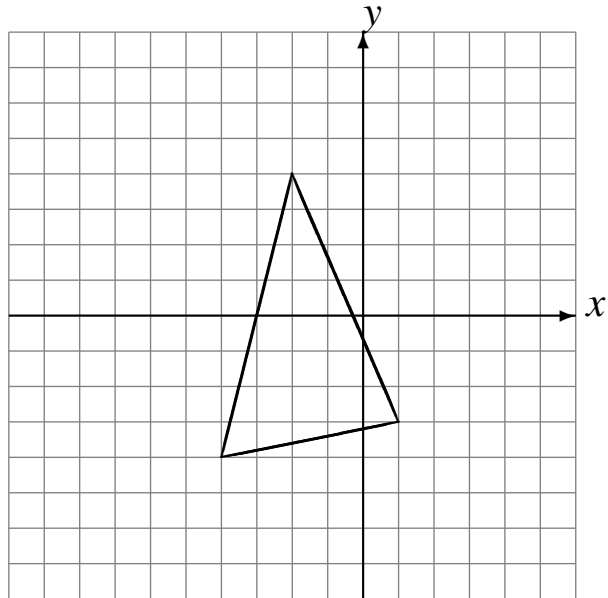

Refleje en  $x = -2$ .  
Refleje en  $y = 0$ .

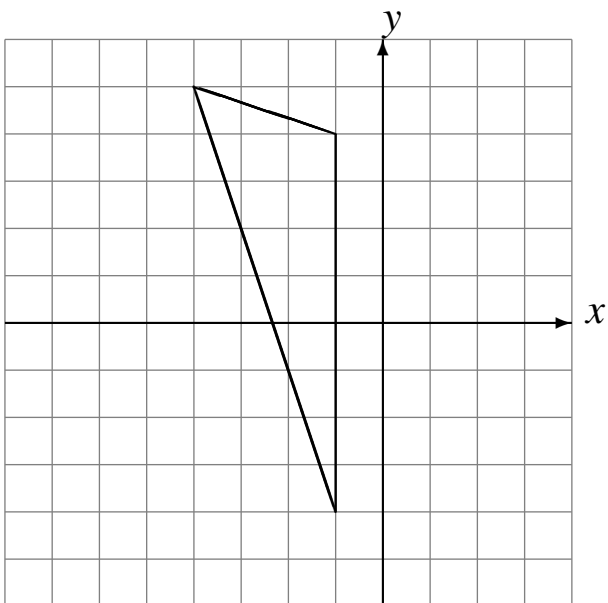

Refleje en  $y = 2$ .  
Refleje en  $x = 4$ .

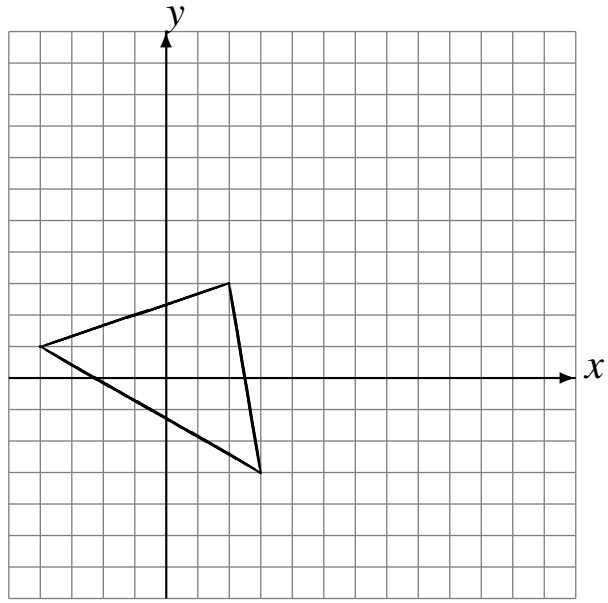

# Reflexiones (A) Respuestas

Dibuje cada figura reflejada.

Refleje en  $x = 4$ .  
Refleje en  $y = -4$ .

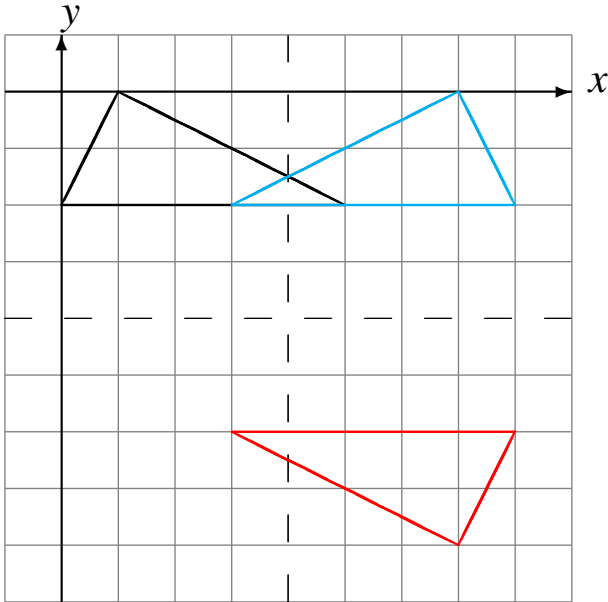

Refleje en  $x = -4$ .  
Refleje en  $x = -2$ .

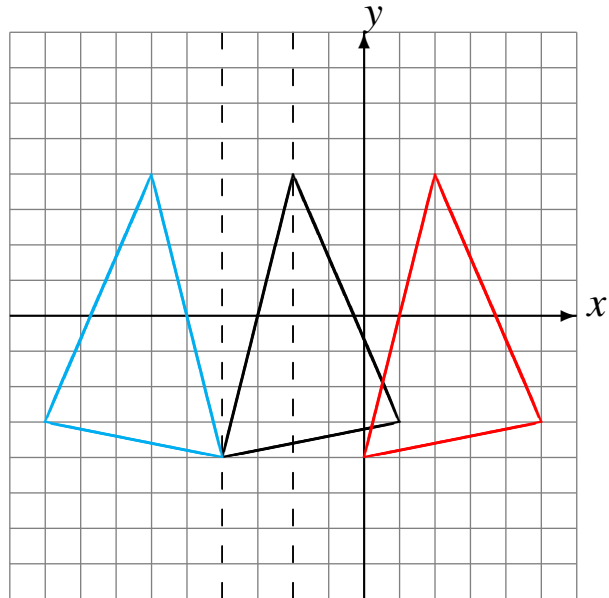

Refleje en  $x = -2$ .  
Refleje en  $y = 0$ .

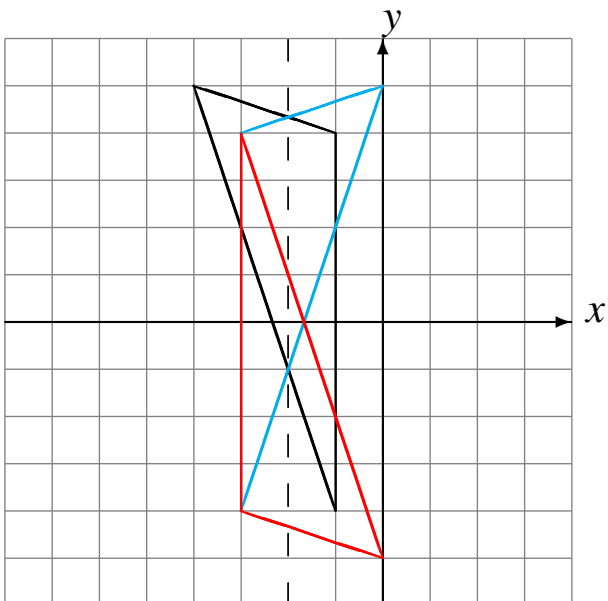

Refleje en  $y = 2$ .  
Refleje en  $x = 4$ .

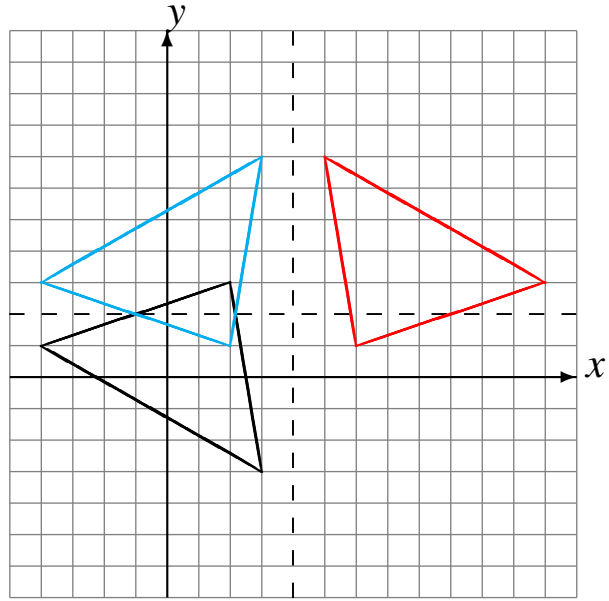

# Reflexiones (B)

Dibuje cada figura reflejada.

Refleje en  $y = 3$ .  
Refleje en  $x = -3$ .

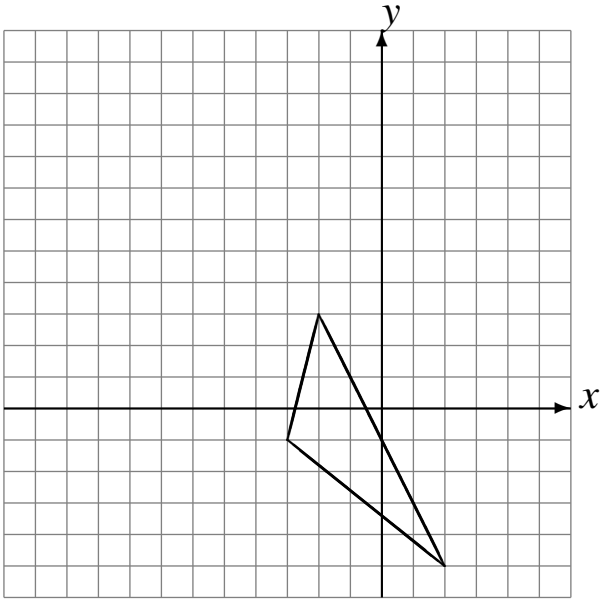

Refleje en  $x = 4$ .  
Refleje en  $y = 0$ .

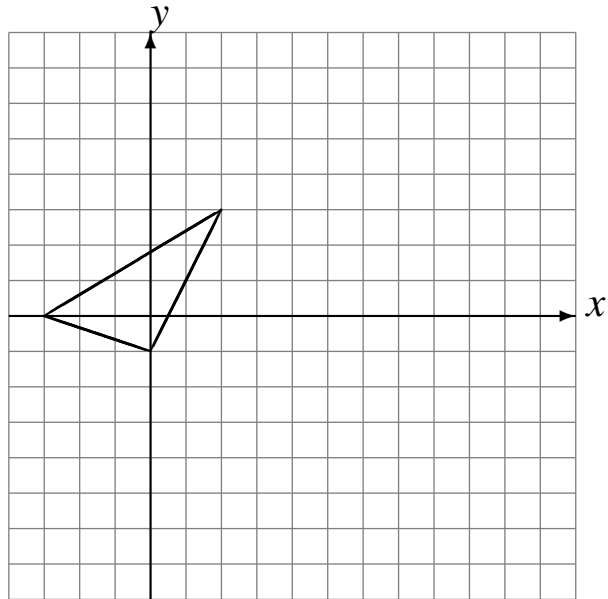

Refleje en  $x = -4$ .  
Refleje en  $y = 0$ .

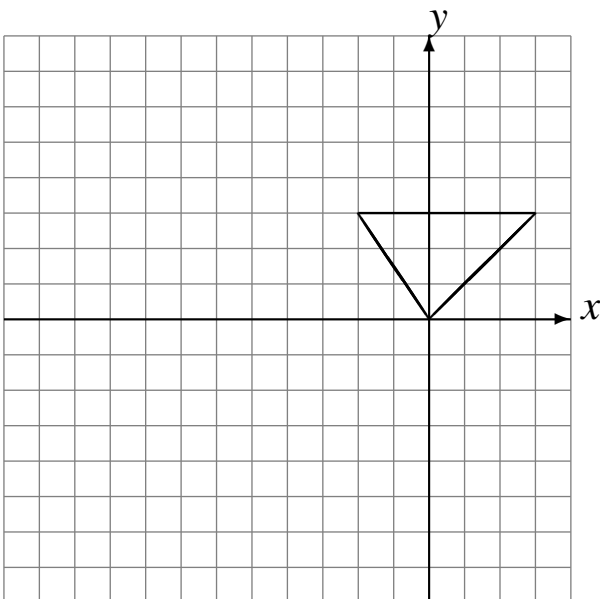

Refleje en  $x = 0$ .  
Refleje en  $y = -1$ .

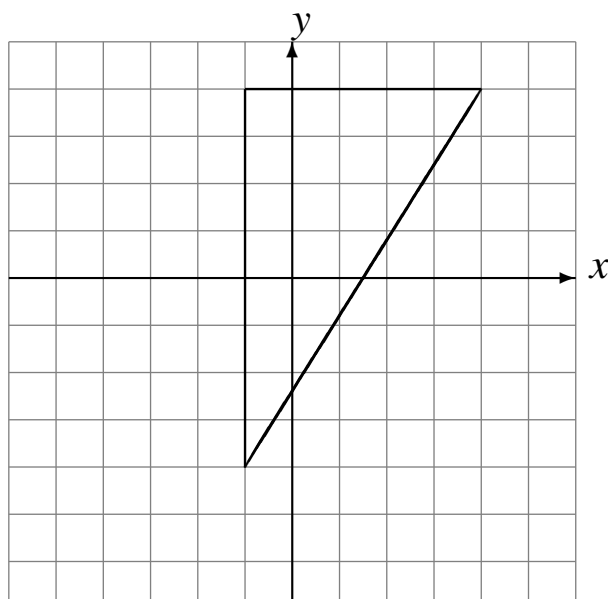

# Reflexiones (B) Respuestas

Dibuje cada figura reflejada.

Refleje en  $y = 3$ .  
Refleje en  $x = -3$ .

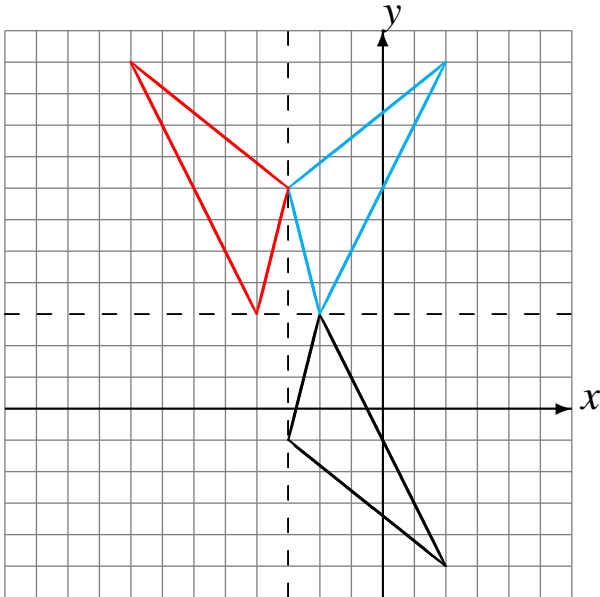

Refleje en  $x = 4$ .  
Refleje en  $y = 0$ .

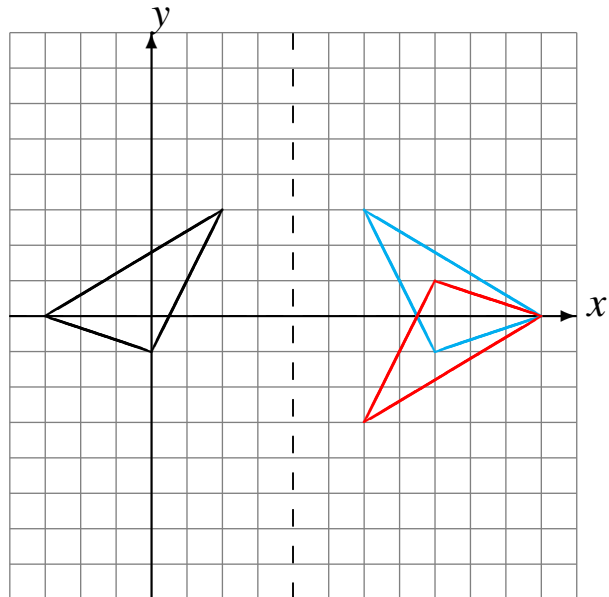

Refleje en  $x = -4$ .  
Refleje en  $y = 0$ .

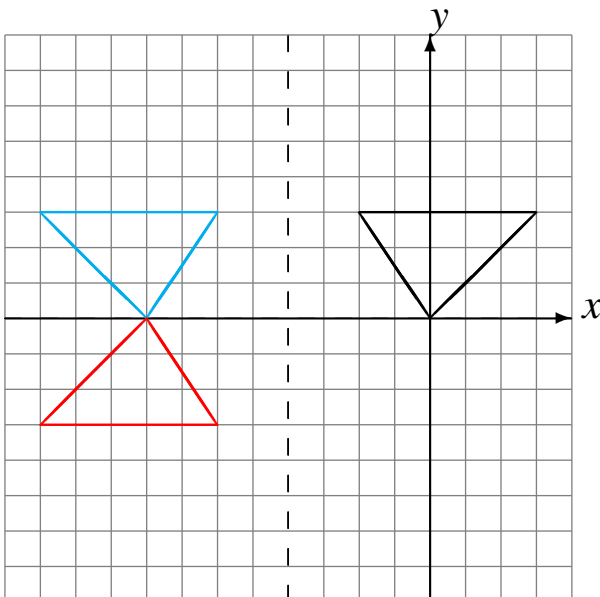

Refleje en  $x = 0$ .  
Refleje en  $y = -1$ .

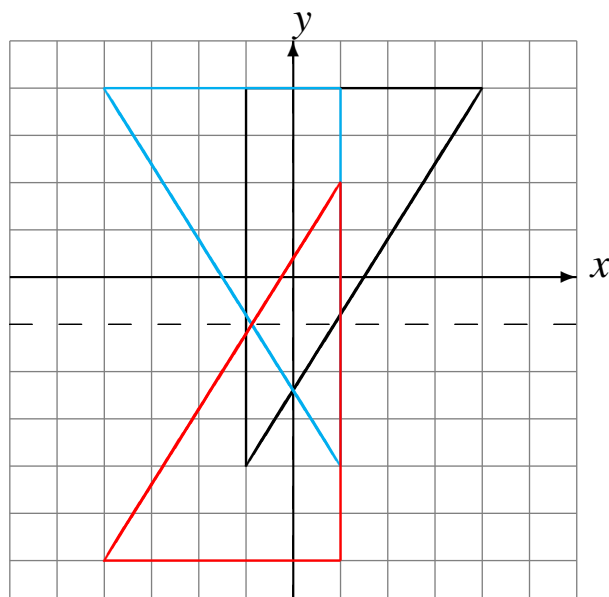

# Reflexiones (C)

Dibuje cada figura reflejada.

Refleje en  $y = 3$ .  
Refleje en  $x = -4$ .

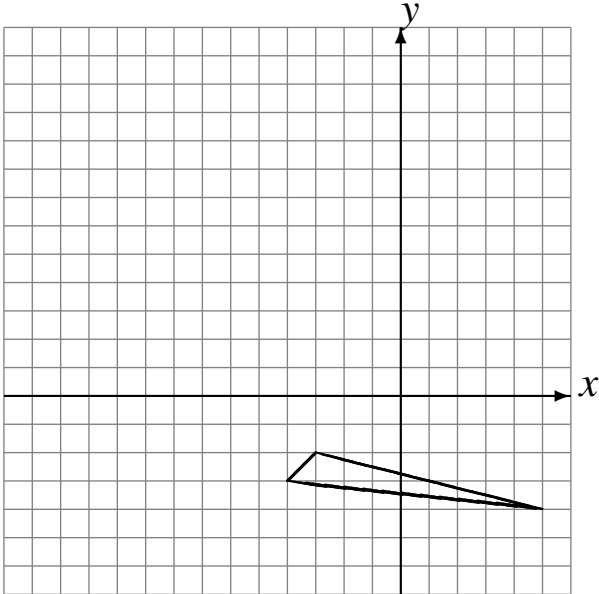

Refleje en  $x = 3$ .  
Refleje en  $x = -1$ .

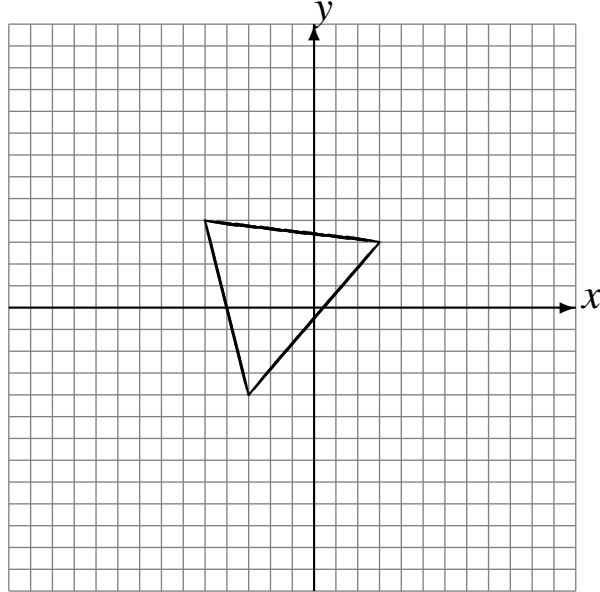

Refleje en  $x = -3$ .  
Refleje en  $x = 3$ .

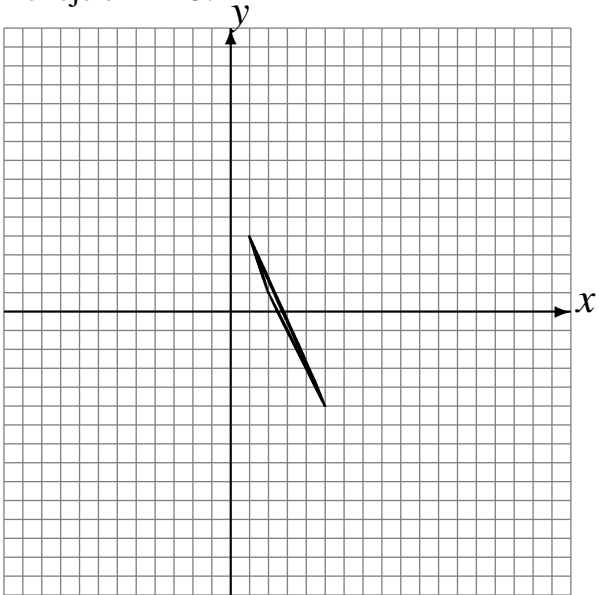

Refleje en  $y = -2$ .  
Refleje en  $x = -2$ .

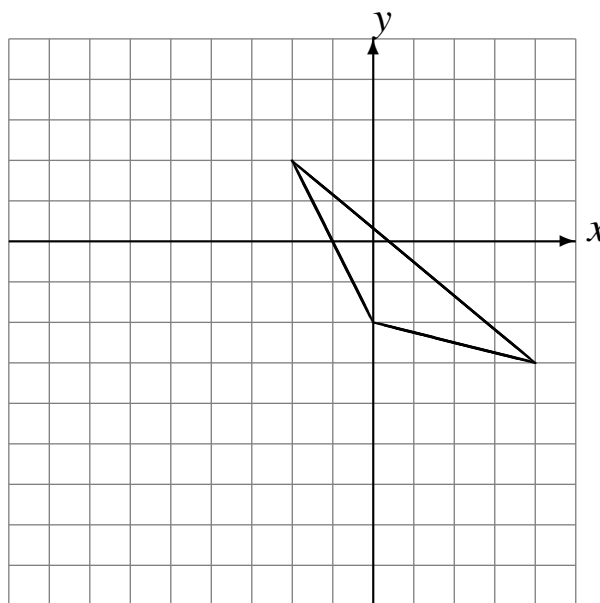

# Reflexiones (C) Respuestas

Dibuje cada figura reflejada.

Refleje en  $y = 3$ .  
Refleje en  $x = -4$ .

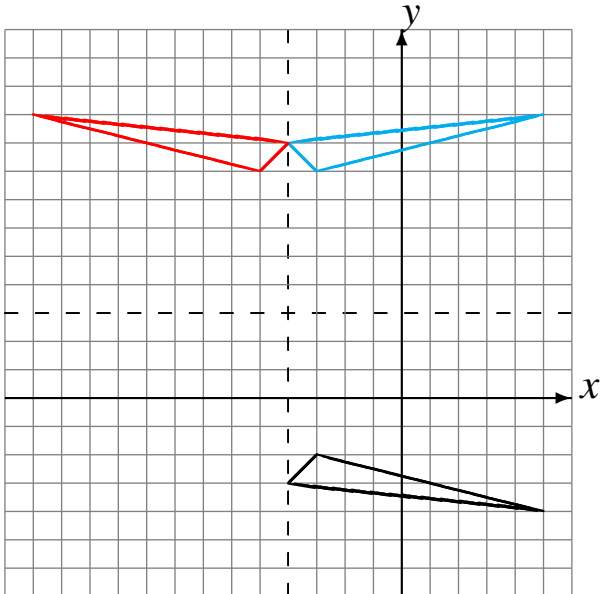

Refleje en  $x = 3$ .  
Refleje en  $x = -1$ .

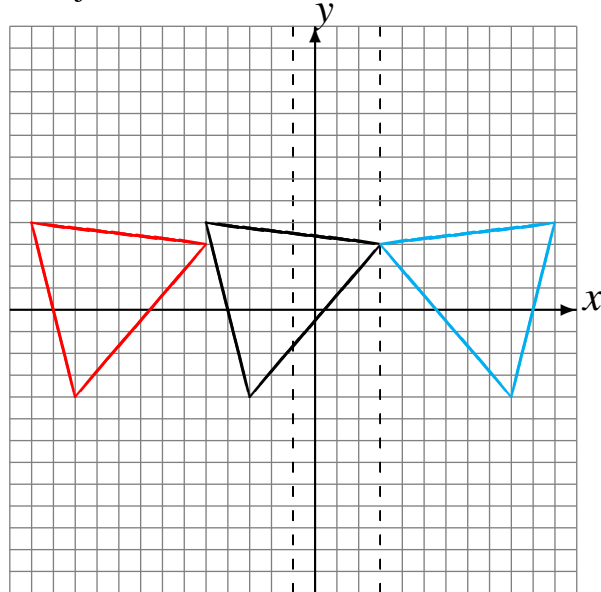

Refleje en  $x = -3$ .  
Refleje en  $x = 3$ .

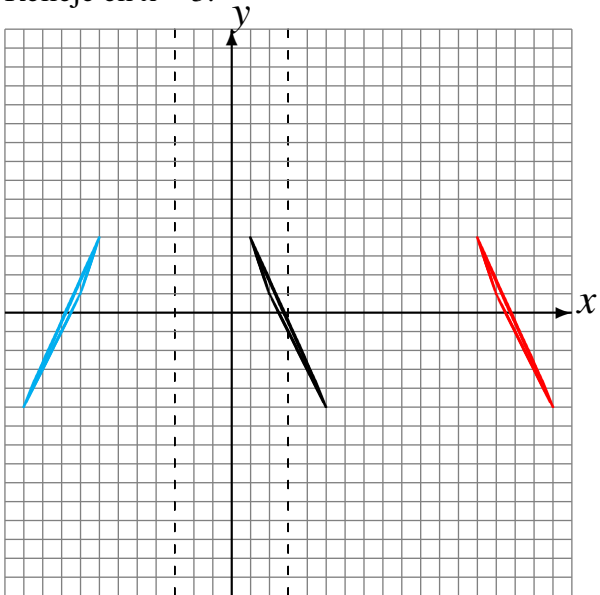

Refleje en  $y = -2$ .  
Refleje en  $x = -2$ .

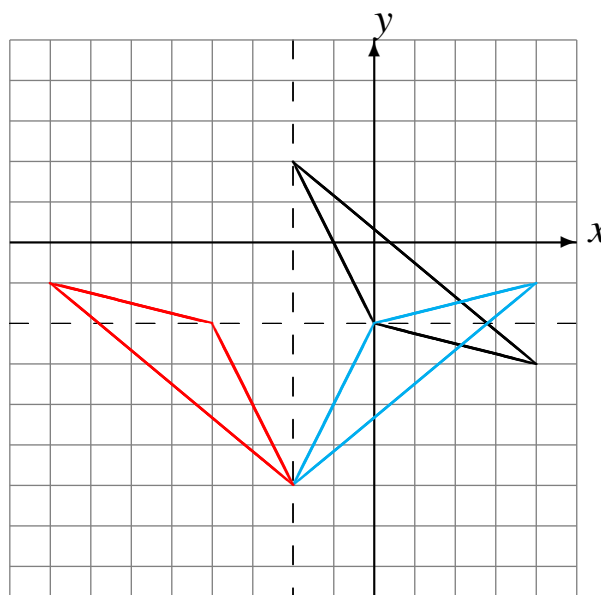

# Reflexiones (D)

Dibuje cada figura reflejada.

Refleje en  $x = 0$ .  
Refleje en  $x = 4$ .

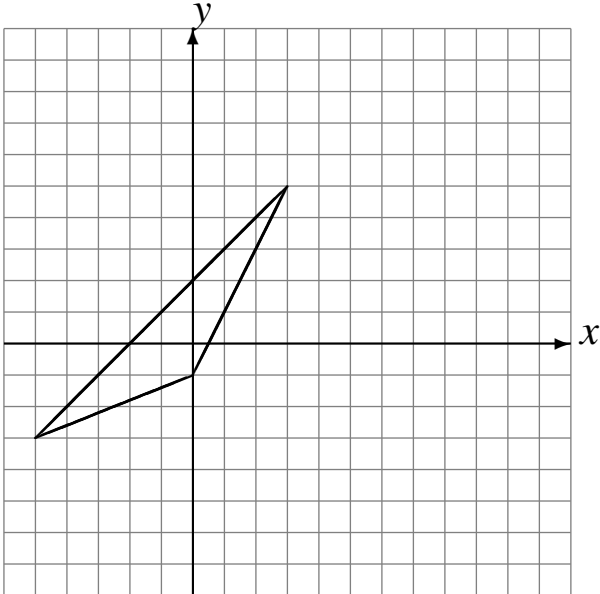

Refleje en  $y = 4$ .  
Refleje en  $y = -2$ .

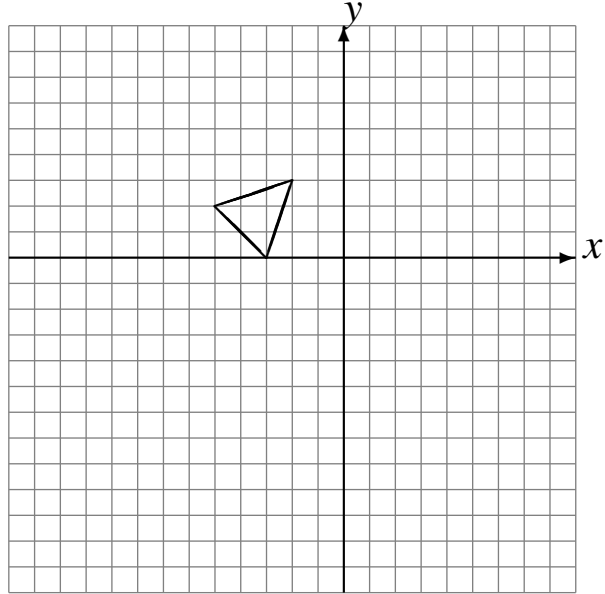

Refleje en  $x = 4$ .  
Refleje en  $x = 1$ .

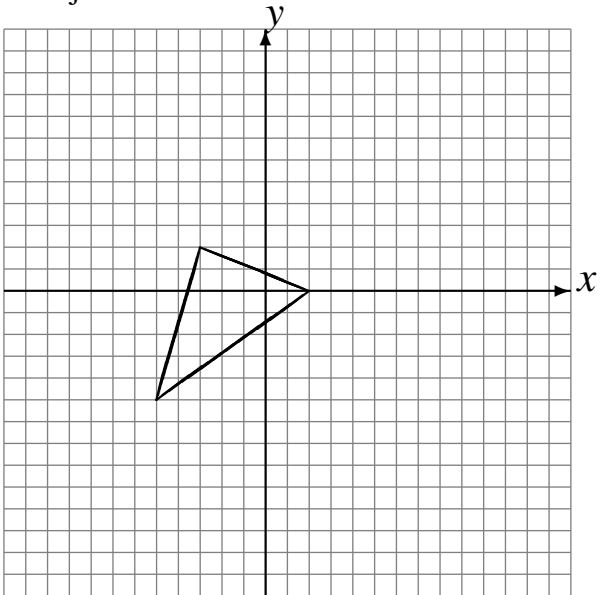

Refleje en  $x = 1$ .  
Refleje en  $y = 3$ .

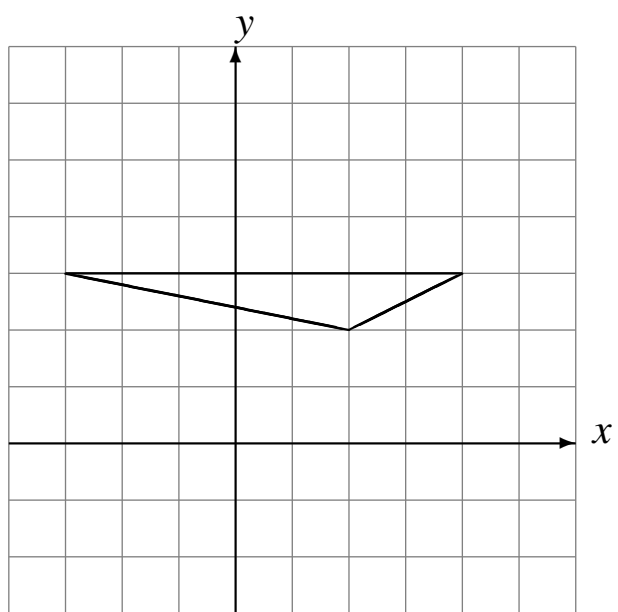

# Reflexiones (D) Respuestas

Dibuje cada figura reflejada.

Refleje en  $x = 0$ .  
Refleje en  $x = 4$ .

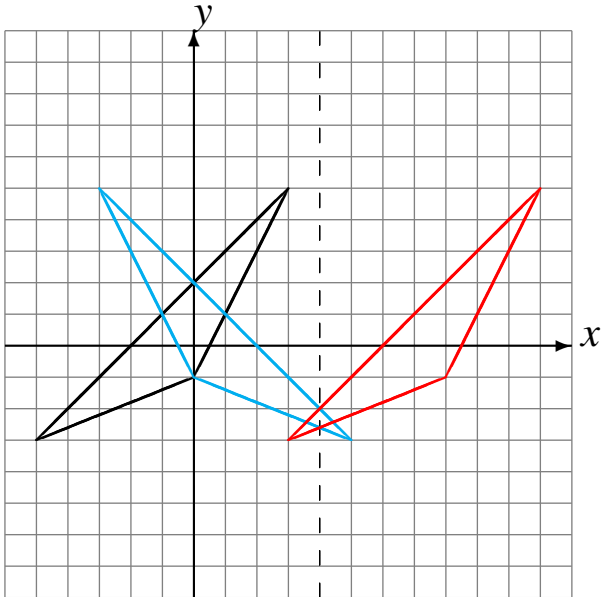

Refleje en  $y = 4$ .  
Refleje en  $y = -2$ .

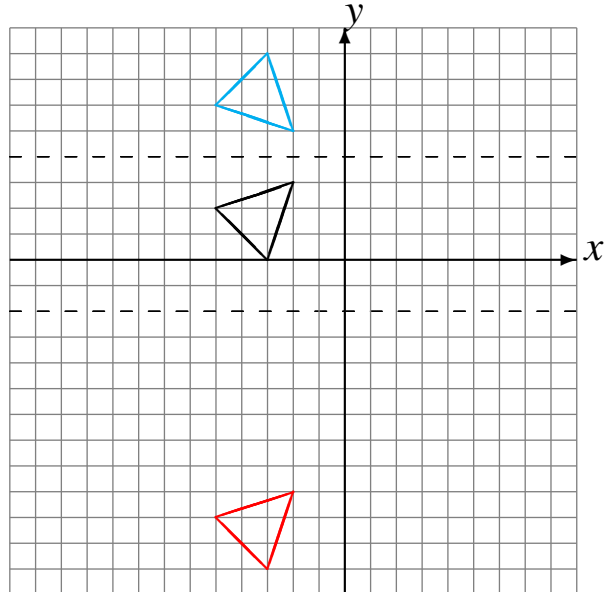

Refleje en  $x = 4$ .  
Refleje en  $x = 1$ .

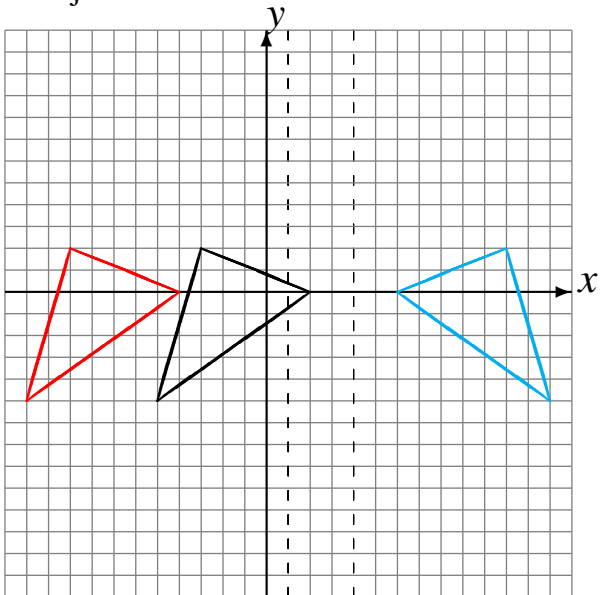

Refleje en  $x = 1$ .  
Refleje en  $y = 3$ .

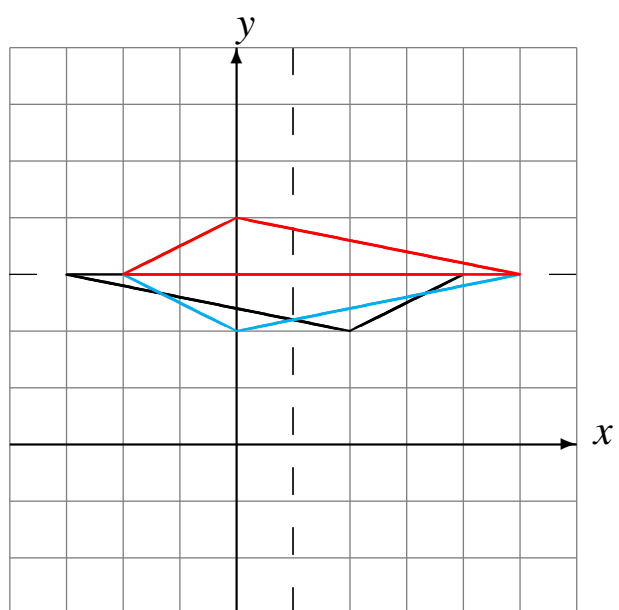



# Reflexiones (E)

Dibuje cada figura reflejada.

Refleje en  $y = -1$ .  
Refleje en  $x = 3$ .

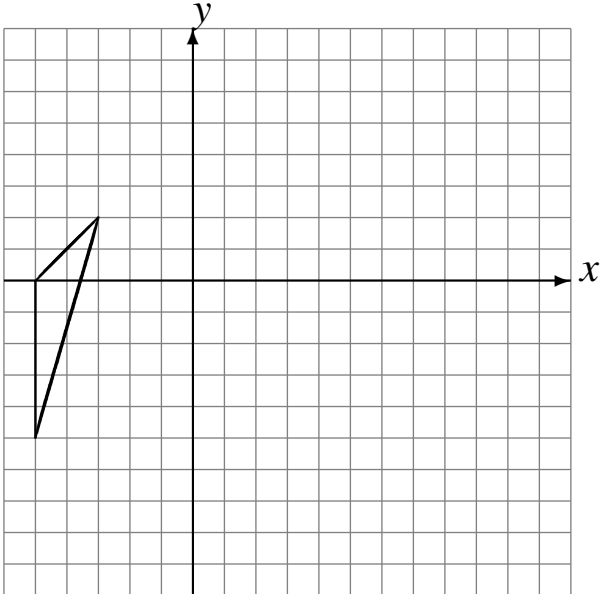

Refleje en  $x = -4$ .  
Refleje en  $y = 1$ .

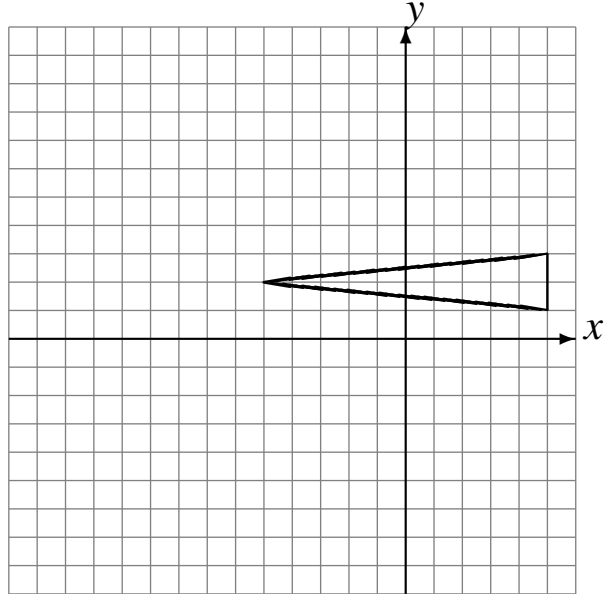

Refleje en  $x = -1$ .  
Refleje en  $y = 0$ .

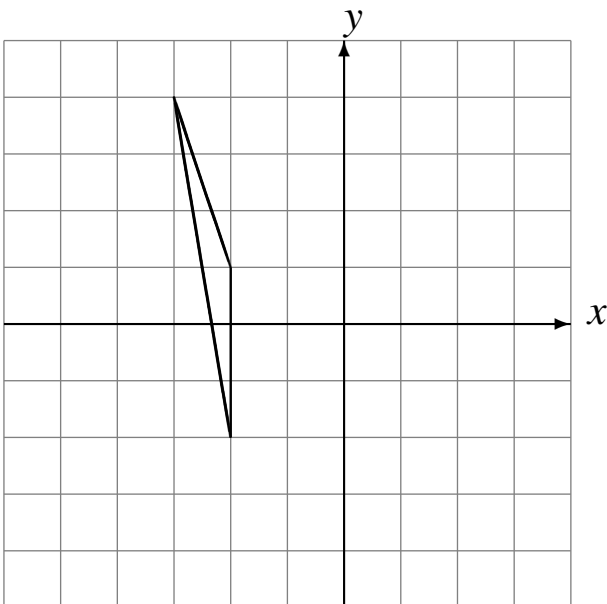

Refleje en  $y = 3$ .  
Refleje en  $x = 4$ .

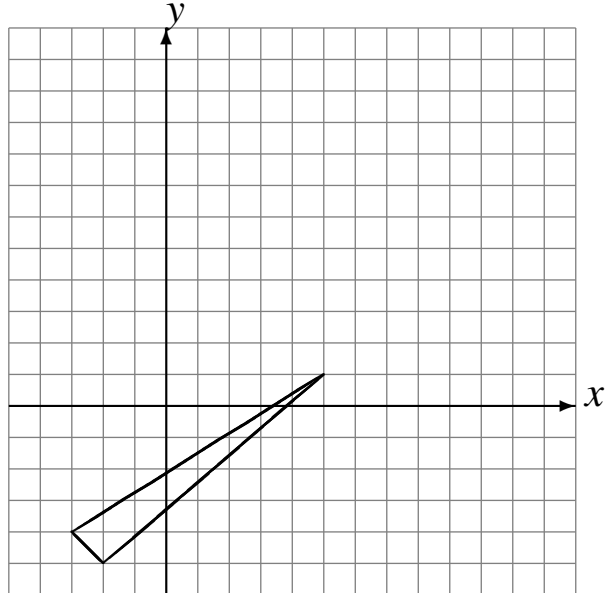

# Reflexiones (E) Respuestas

Dibuje cada figura reflejada.

Refleje en  $y = -1$ .  
Refleje en  $x = 3$ .

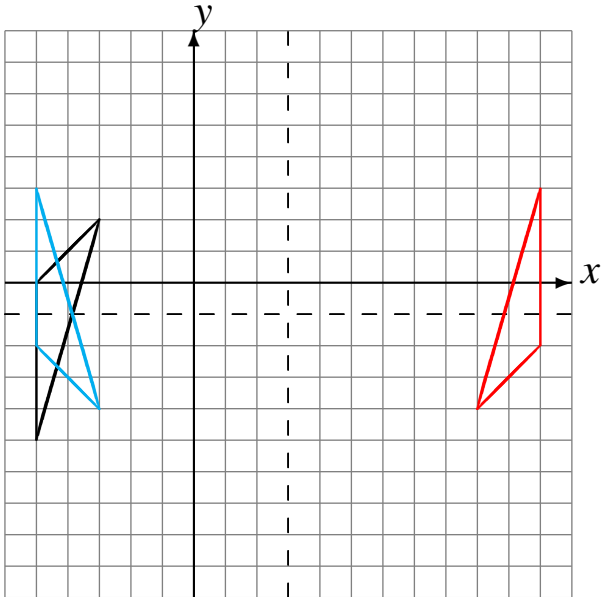

Refleje en  $x = -4$ .  
Refleje en  $y = 1$ .

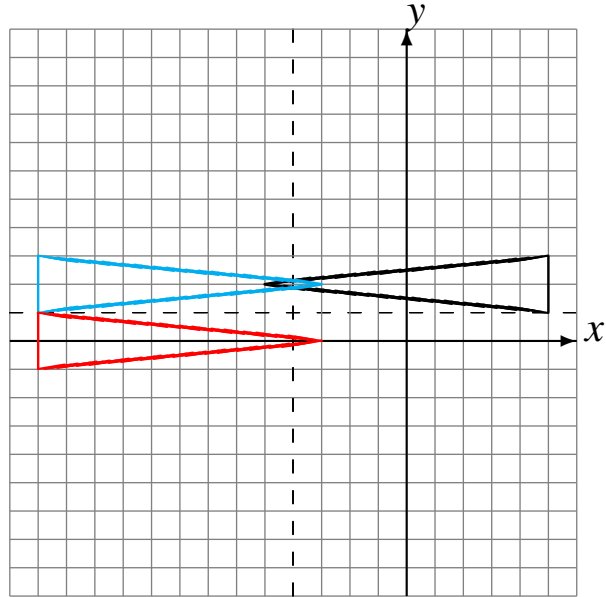

Refleje en  $x = -1$ .  
Refleje en  $y = 0$ .

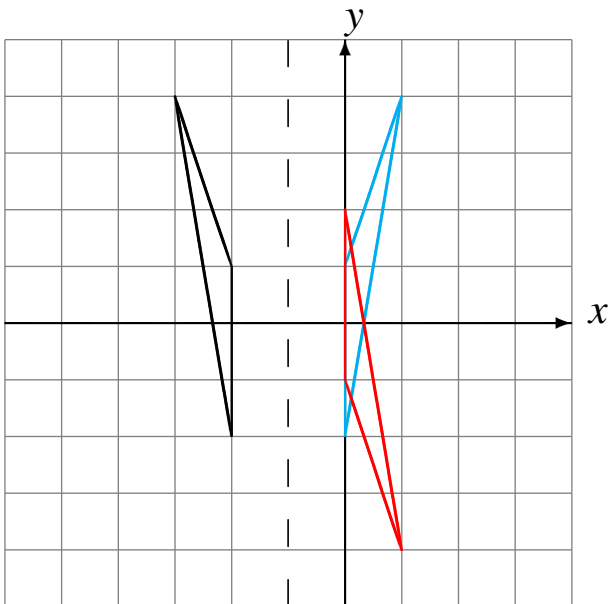

Refleje en  $y = 3$ .  
Refleje en  $x = 4$ .

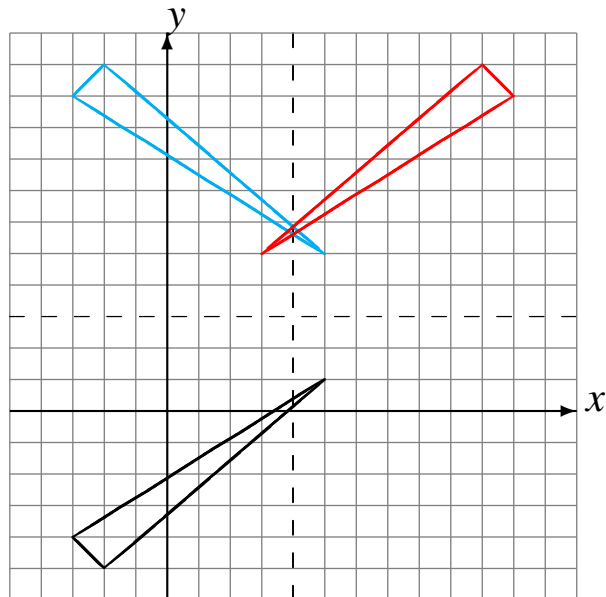

# Reflexiones (F)

Dibuje cada figura reflejada.

Refleje en  $y = -1$ .  
Refleje en  $y = 2$ .

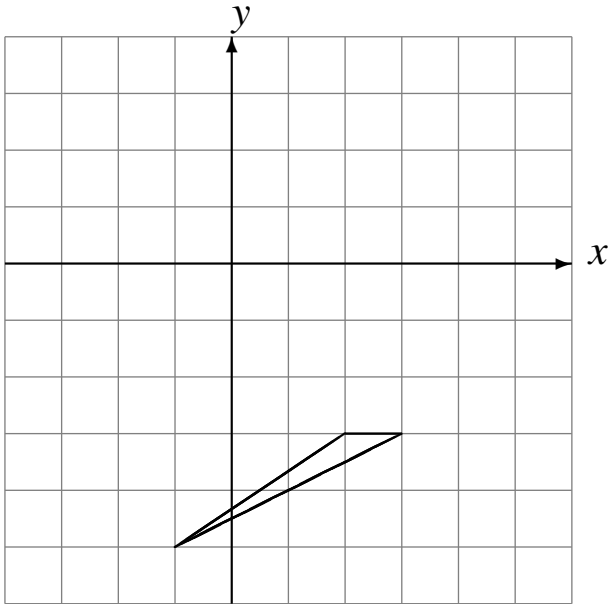

Refleje en  $y = -1$ .  
Refleje en  $y = -4$ .

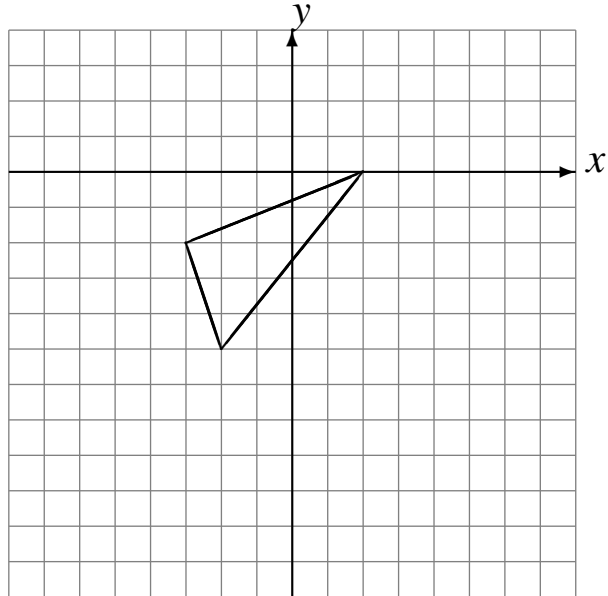

Refleje en  $y = 3$ .  
Refleje en  $y = -1$ .

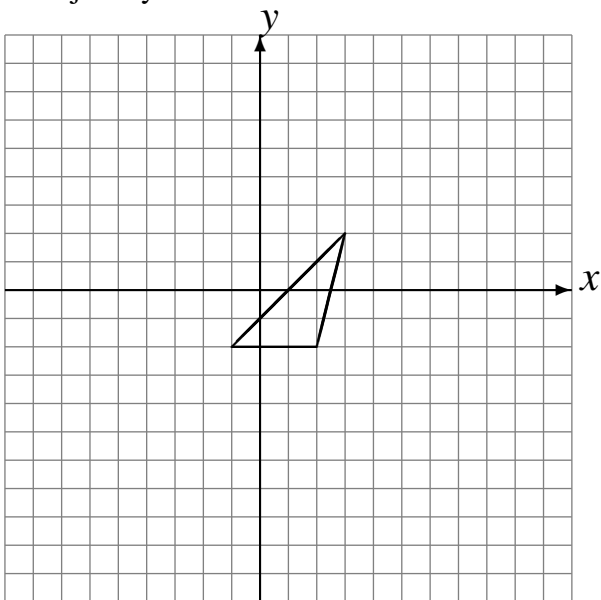

Refleje en  $x = -2$ .  
Refleje en  $x = -2$ .

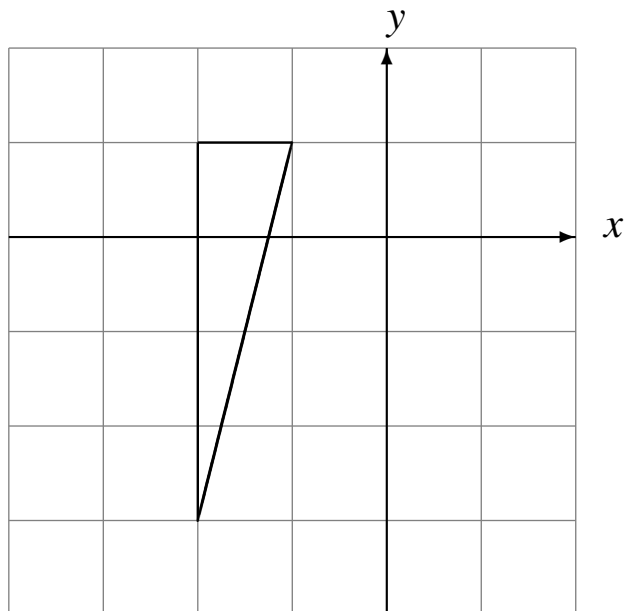

# Reflexiones (F) Respuestas

Dibuje cada figura reflejada.

Refleje en  $y = -1$ .  
Refleje en  $y = 2$ .

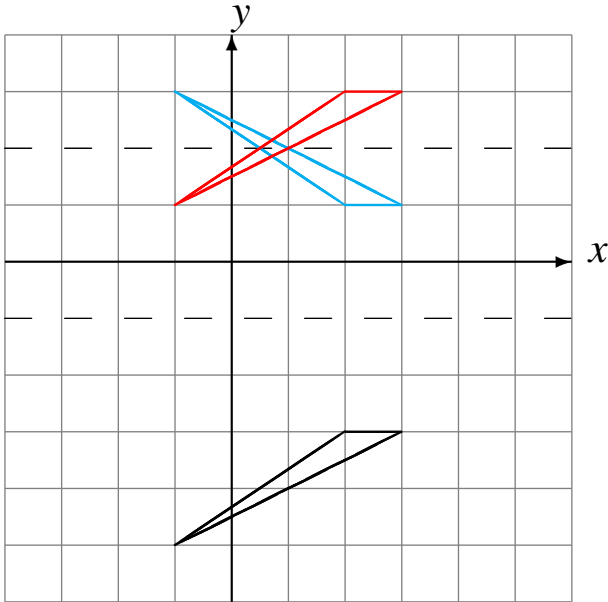

Refleje en  $y = -1$ .  
Refleje en  $y = -4$ .

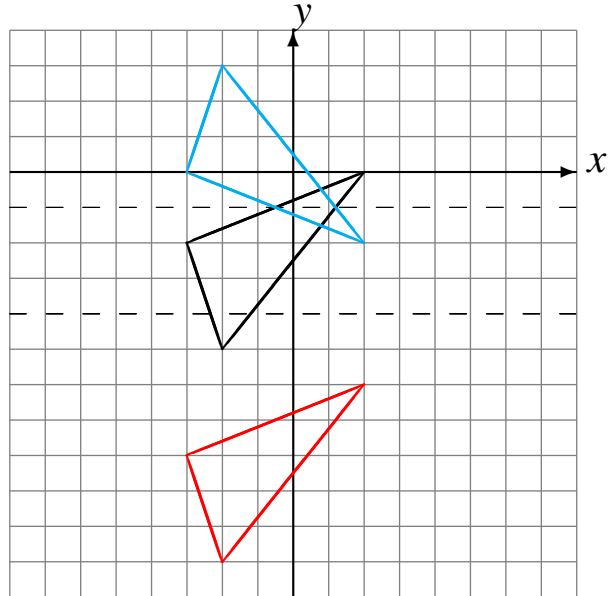

Refleje en  $y = 3$ .  
Refleje en  $y = -1$ .

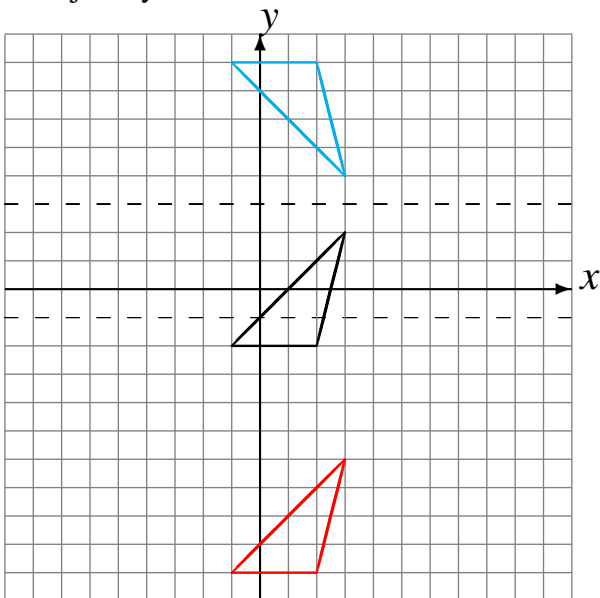

Refleje en  $x = -2$ .  
Refleje en  $x = -2$ .

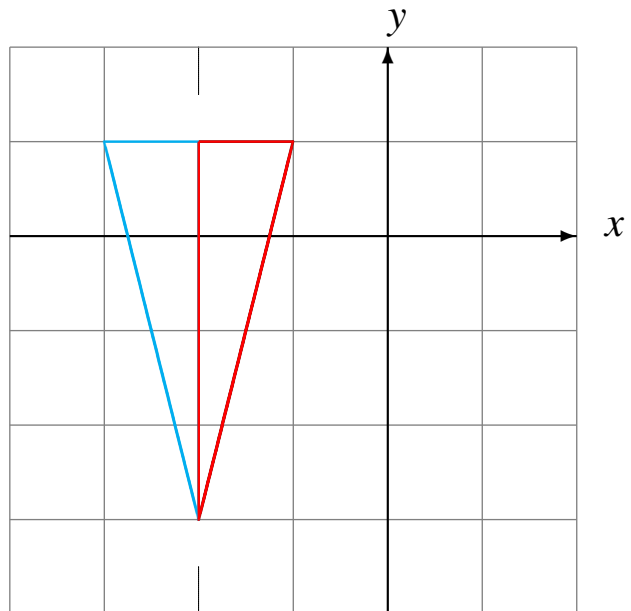

# Reflexiones (G)

Dibuje cada figura reflejada.

Refleje en  $y = -3$ .  
Refleje en  $y = 2$ .

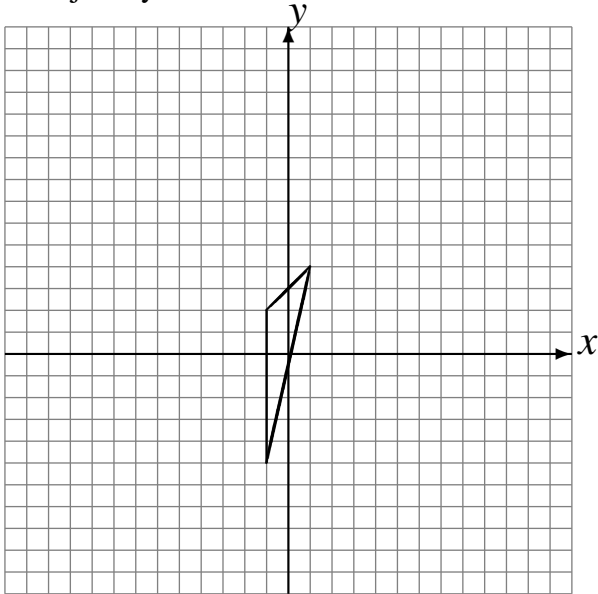

Refleje en  $x = 3$ .  
Refleje en  $x = -2$ .

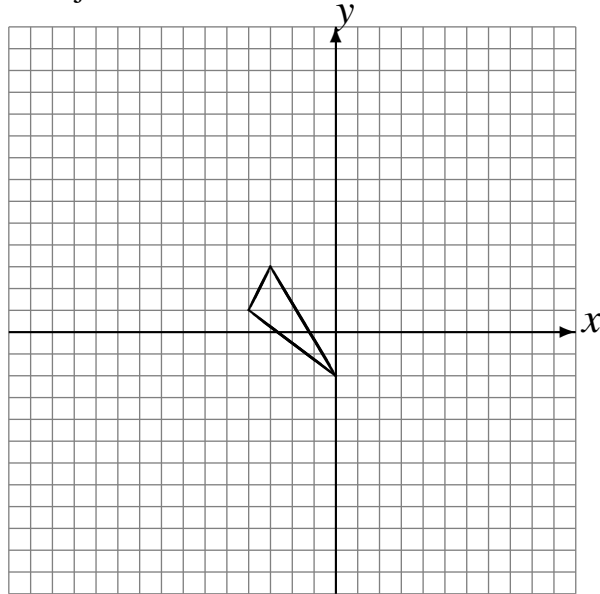

Refleje en  $y = -2$ .  
Refleje en  $y = 3$ .

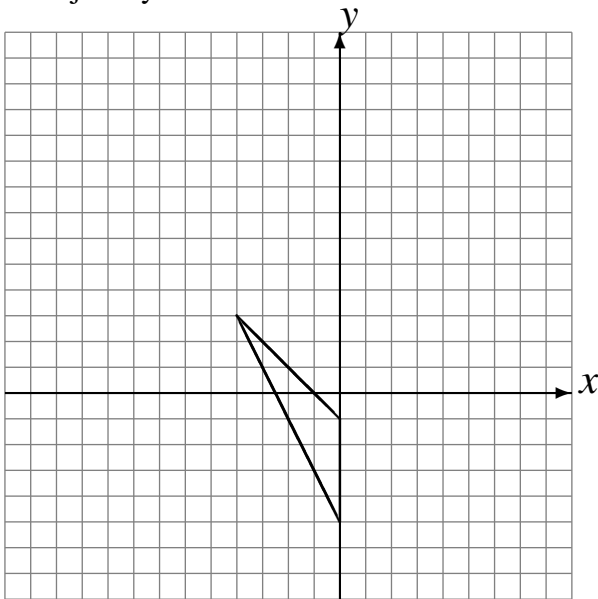

Refleje en  $y = -2$ .  
Refleje en  $y = -2$ .

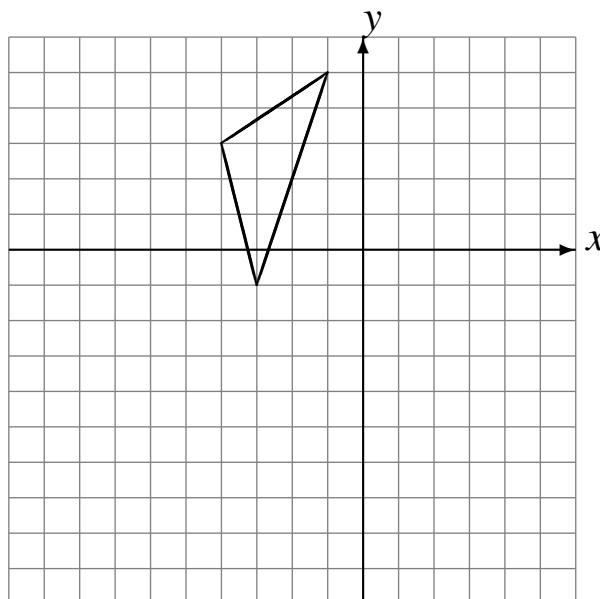

# Reflexiones (G) Respuestas

Dibuje cada figura reflejada.

Refleje en  $y = -3$ .  
Refleje en  $y = 2$ .

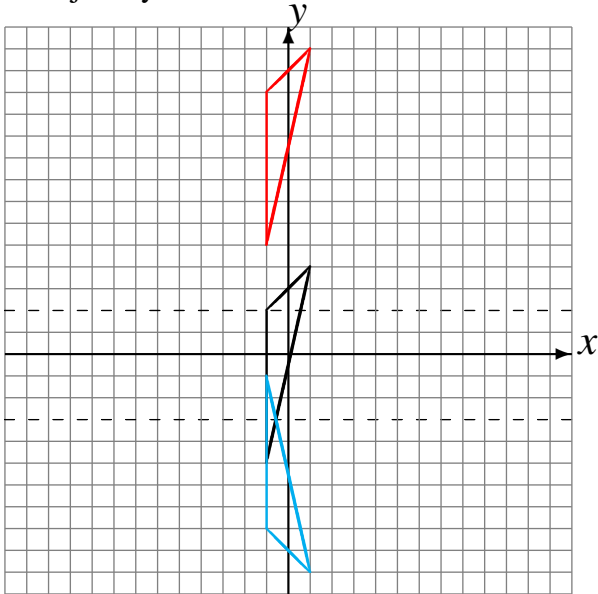

Refleje en  $x = 3$ .  
Refleje en  $x = -2$ .

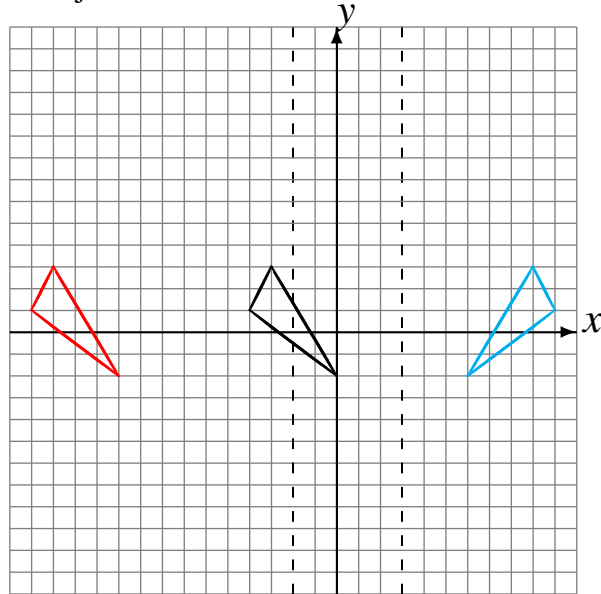

Refleje en  $y = -2$ .  
Refleje en  $y = 3$ .

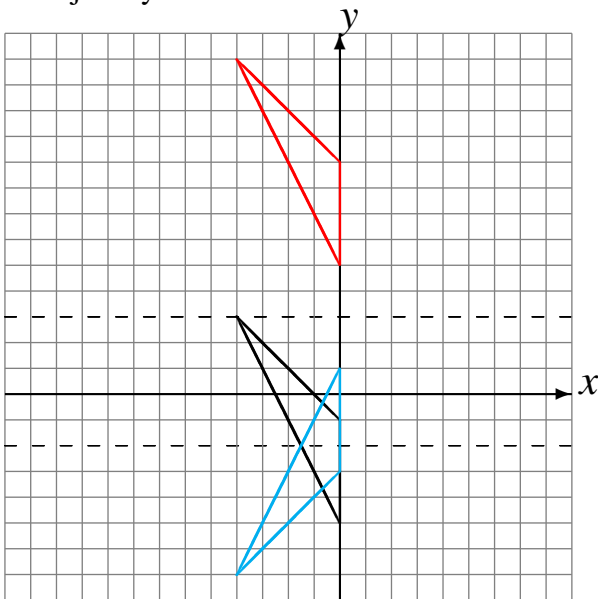

Refleje en  $y = -2$ .  
Refleje en  $y = -2$ .

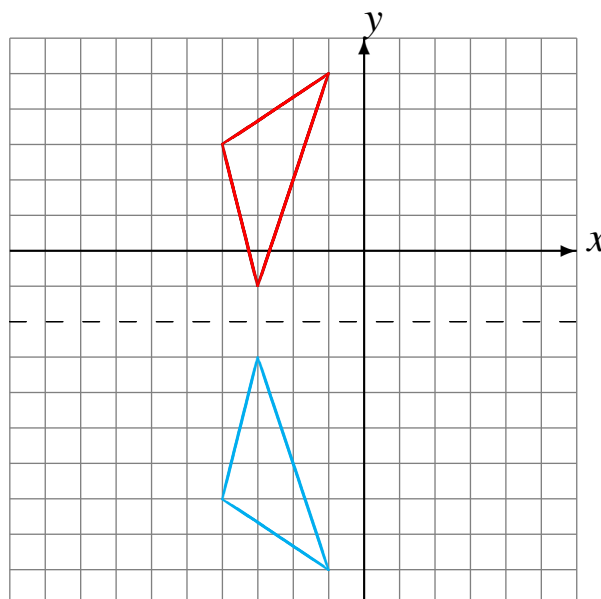

# Reflexiones (H)

Dibuje cada figura reflejada.

Refleje en  $x = 3$ .  
Refleje en  $y = -3$ .

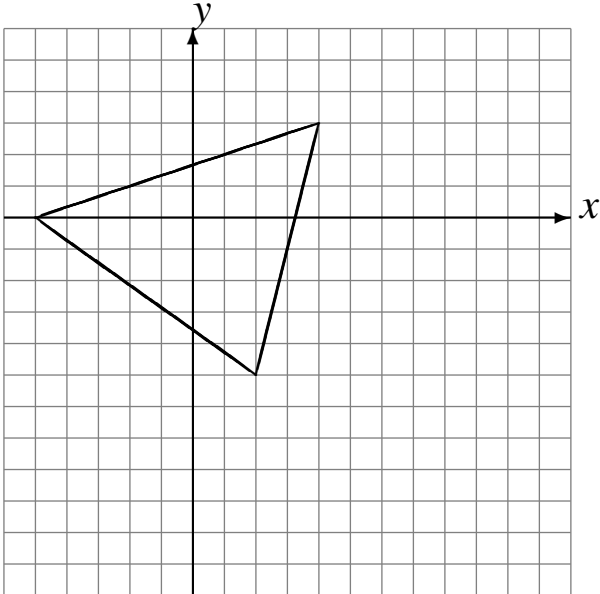

Refleje en  $y = 1$ .  
Refleje en  $x = 4$ .

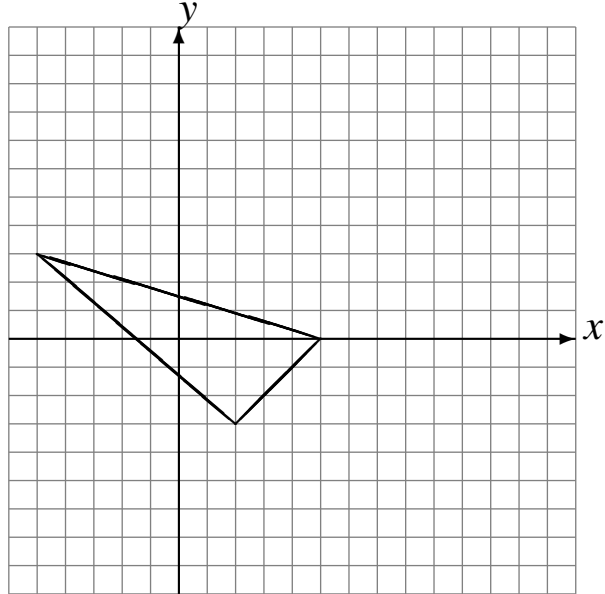

Refleje en  $x = 3$ .  
Refleje en  $y = -2$ .

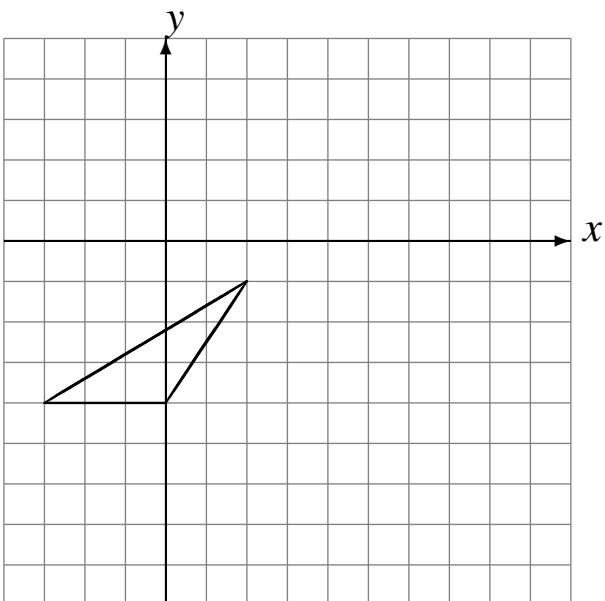

Refleje en  $y = 3$ .  
Refleje en  $x = -2$ .

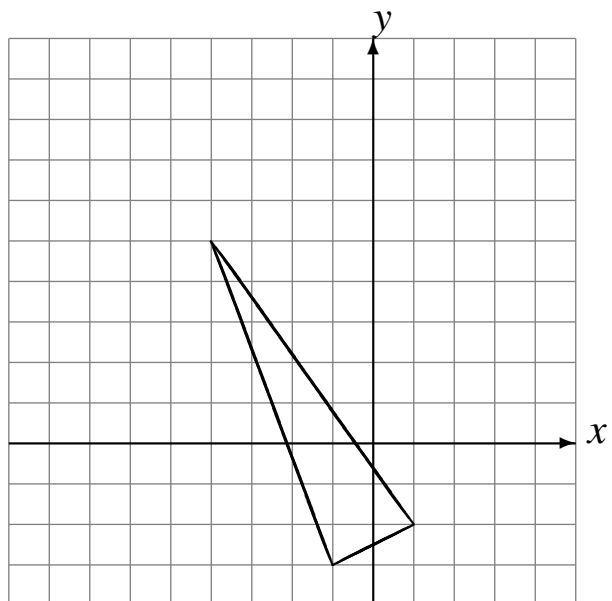

# Reflexiones (H) Respuestas

Dibuje cada figura reflejada.

Refleje en  $x = 3$ .  
Refleje en  $y = -3$ .

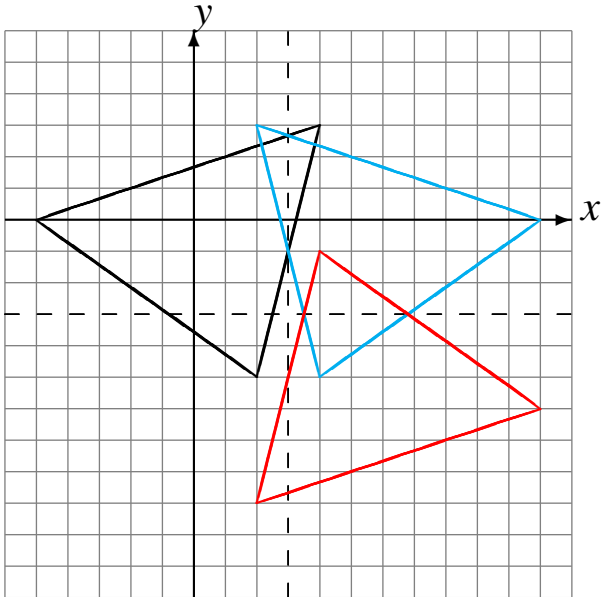

Refleje en  $y = 1$ .  
Refleje en  $x = 4$ .

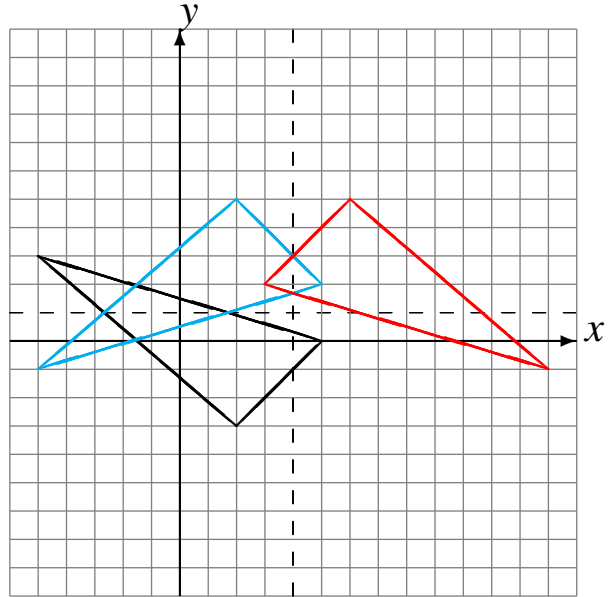

Refleje en  $x = 3$ .  
Refleje en  $y = -2$ .

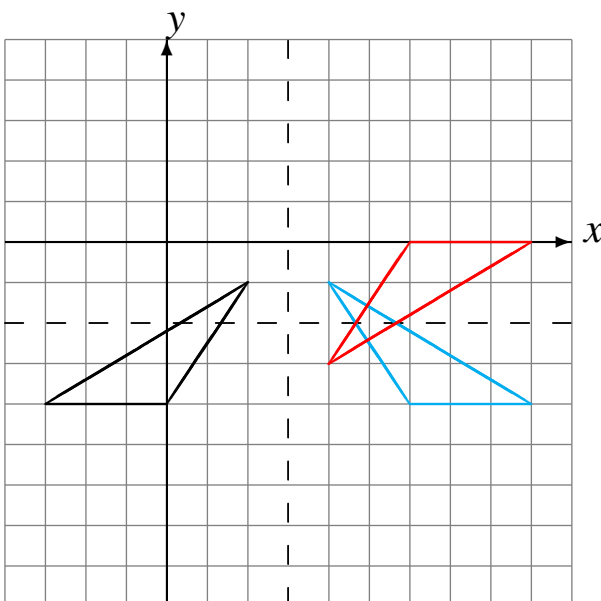

Refleje en  $y = 3$ .  
Refleje en  $x = -2$ .

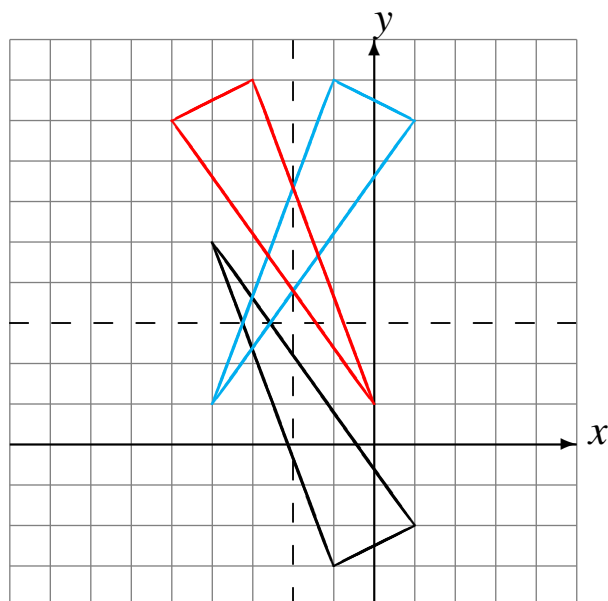



# Reflexiones (I)

Dibuje cada figura reflejada.

Refleje en  $x = -1$ .  
Refleje en  $y = 4$ .

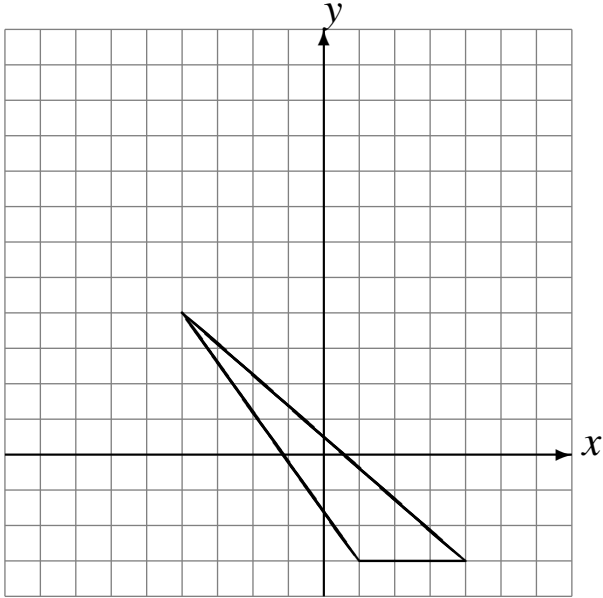

Refleje en  $x = 4$ .  
Refleje en  $y = -2$ .

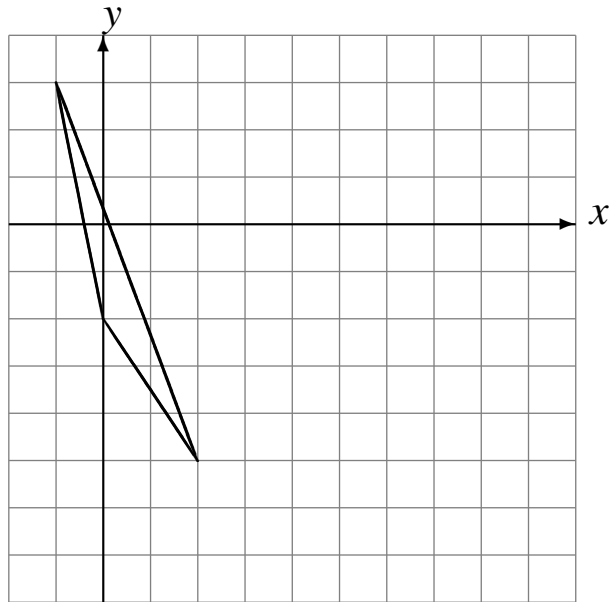

Refleje en  $x = -3$ .  
Refleje en  $x = -1$ .

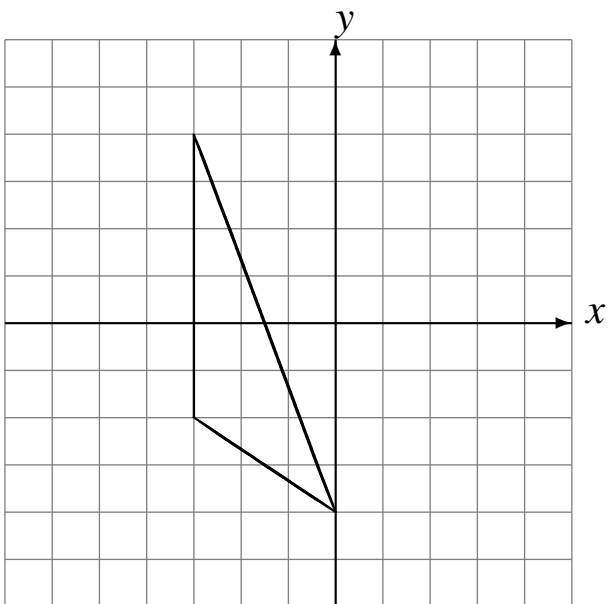

Refleje en  $y = -1$ .  
Refleje en  $x = 4$ .

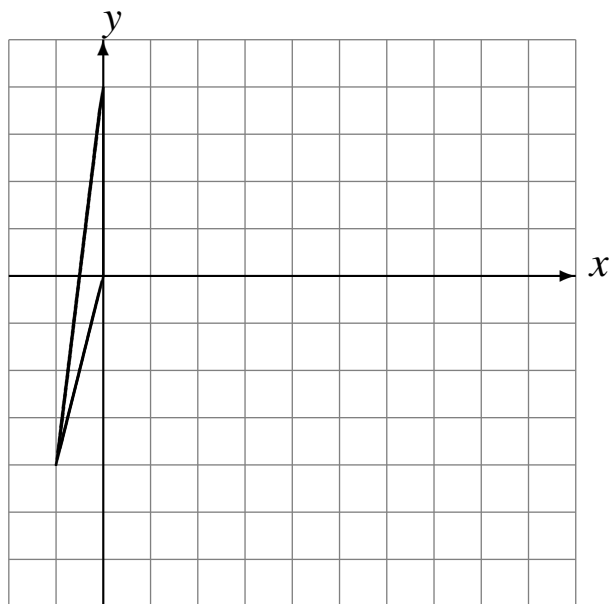

# Reflexiones (I) Respuestas

Dibuje cada figura reflejada.

Refleje en  $x = -1$ .  
Refleje en  $y = 4$ .

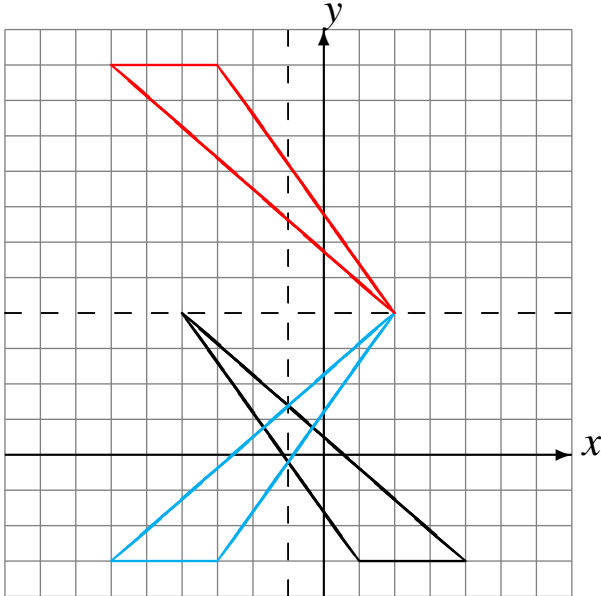

Refleje en  $x = 4$ .  
Refleje en  $y = -2$ .

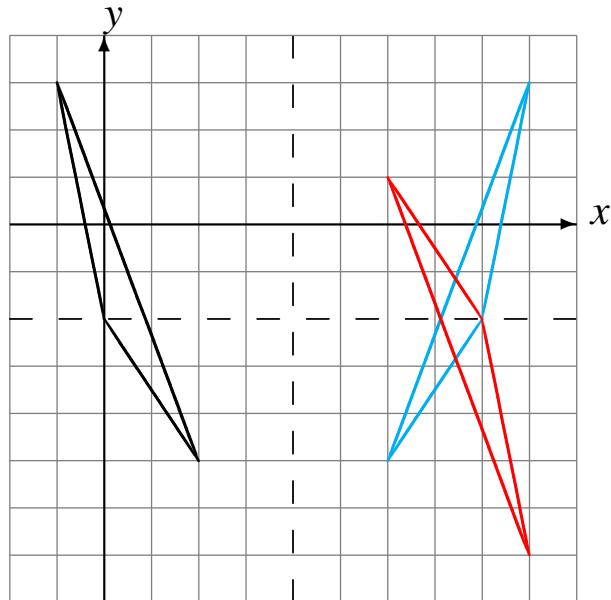

Refleje en  $x = -3$ .  
Refleje en  $x = -1$ .

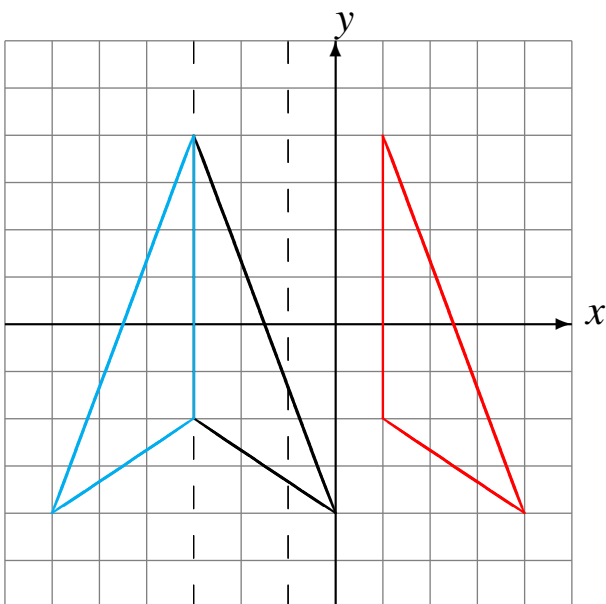

Refleje en  $y = -1$ .  
Refleje en  $x = 4$ .

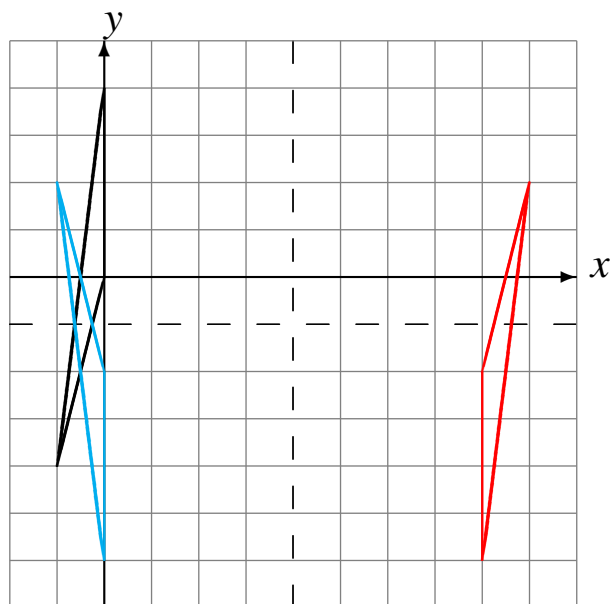

# Reflexiones (J)

Dibuje cada figura reflejada.

Refleje en  $x = -3$ .  
Refleje en  $y = 0$ .

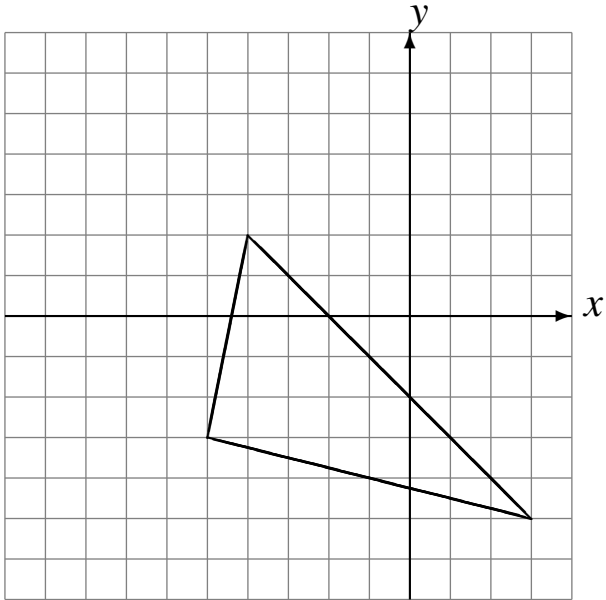

Refleje en  $y = 2$ .  
Refleje en  $x = -2$ .

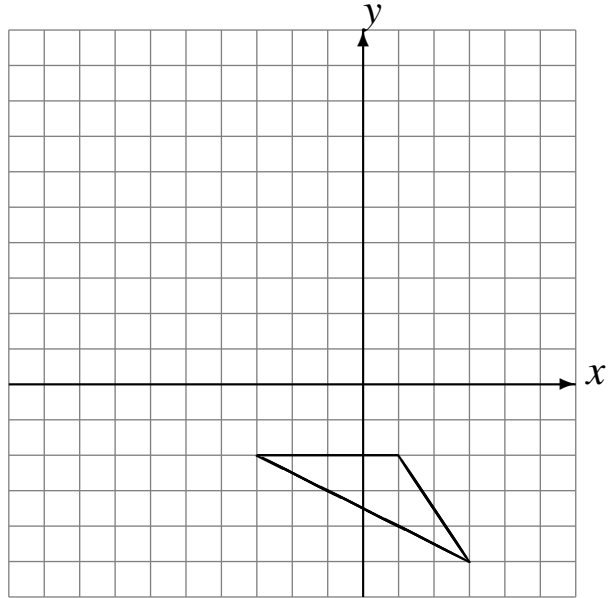

Refleje en  $y = 2$ .  
Refleje en  $y = 3$ .

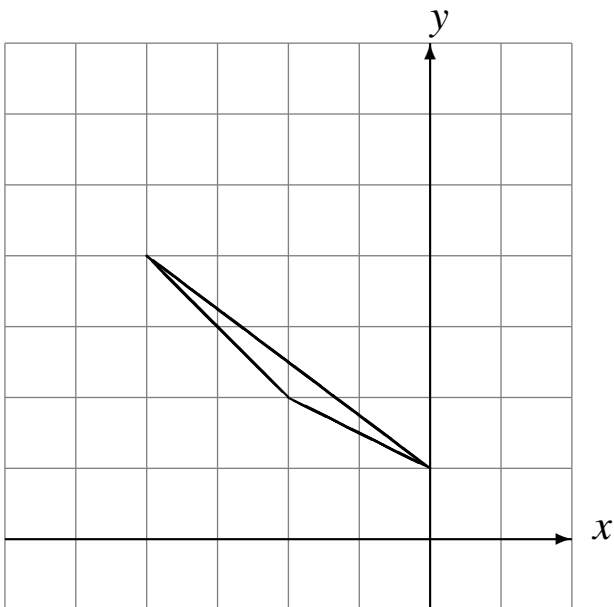

Refleje en  $y = -4$ .  
Refleje en  $x = 0$ .

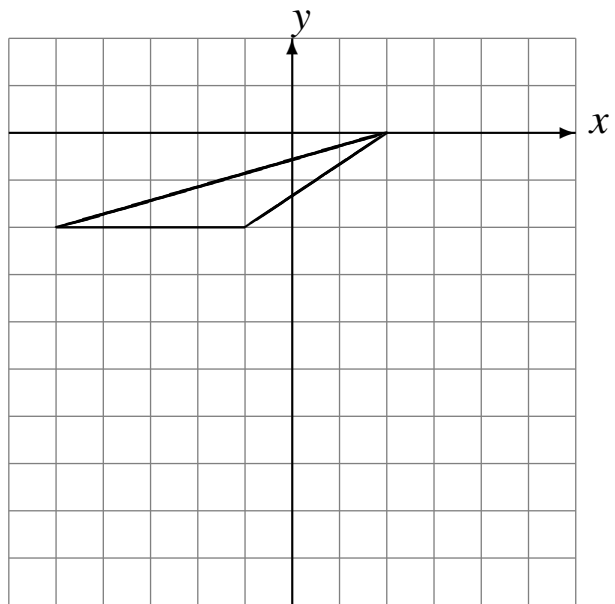

# Reflexiones (J) Respuestas

Dibuje cada figura reflejada.

Refleje en  $x = -3$ .  
Refleje en  $y = 0$ .

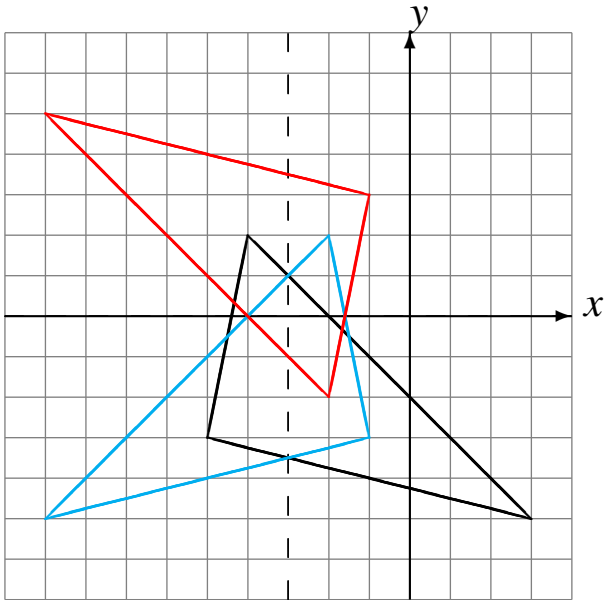

Refleje en  $y = 2$ .  
Refleje en  $x = -2$ .

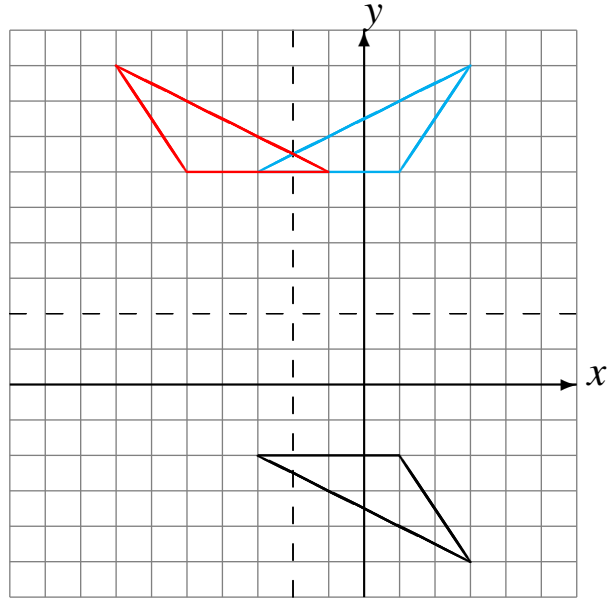

Refleje en  $y = 2$ .  
Refleje en  $y = 3$ .

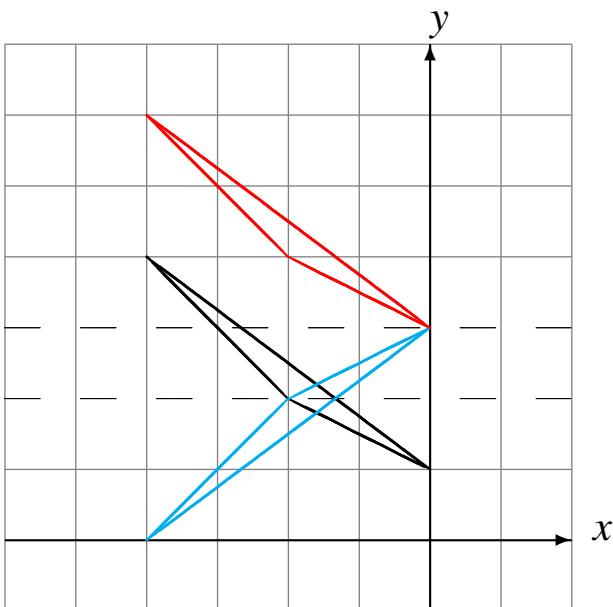

Refleje en  $y = -4$ .  
Refleje en  $x = 0$ .

