

Rotaciones (A)

Dibuje cada figura rotada.

Rote 90° alrededor de $(1, -3)$.

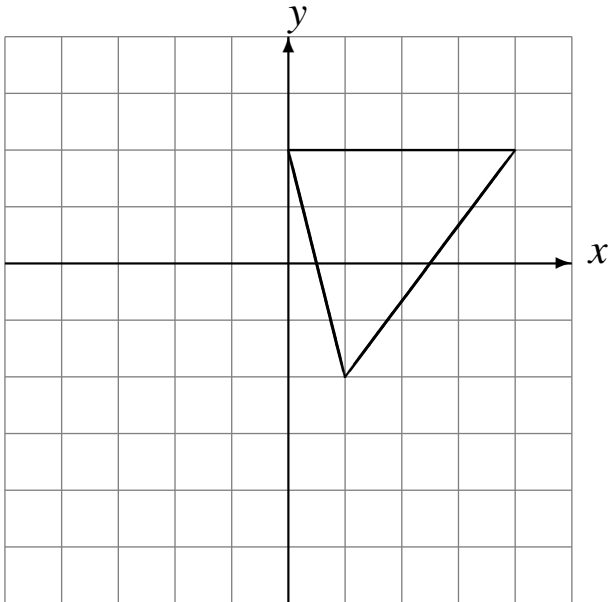

Rote -90° alrededor de $(0, 1)$.

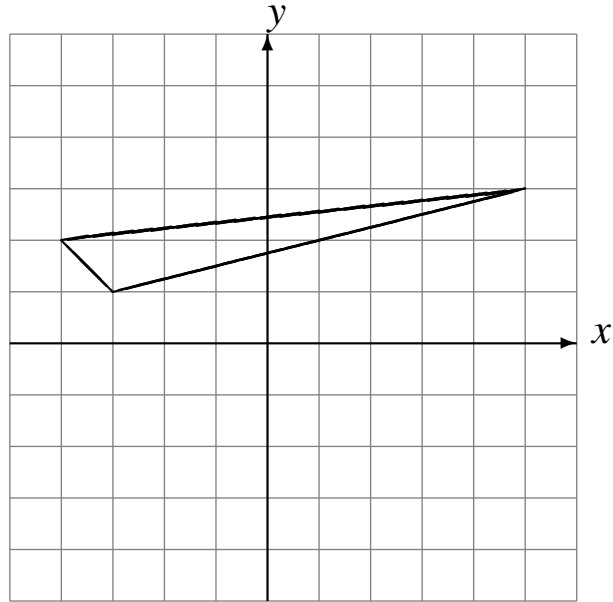

Rote -90° alrededor de $(-3, 3)$.

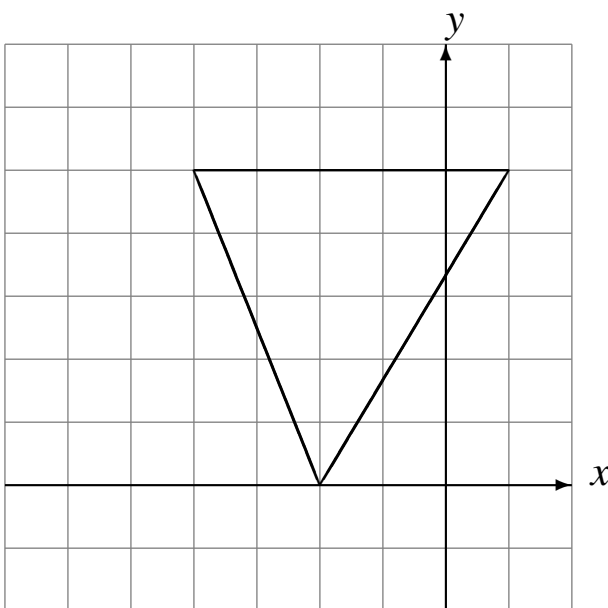

Rote 180° alrededor de $(-1, 4)$.

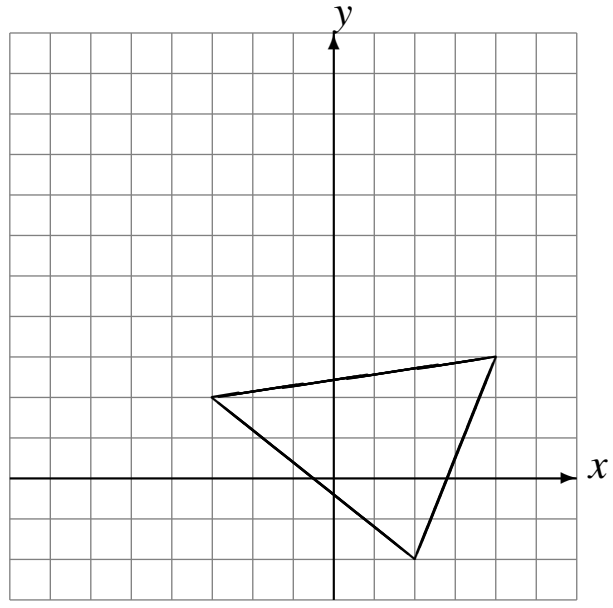

Rotaciones (A) Respuestas

Dibuje cada figura rotada.

Rote 90° alrededor de $(1, -3)$.

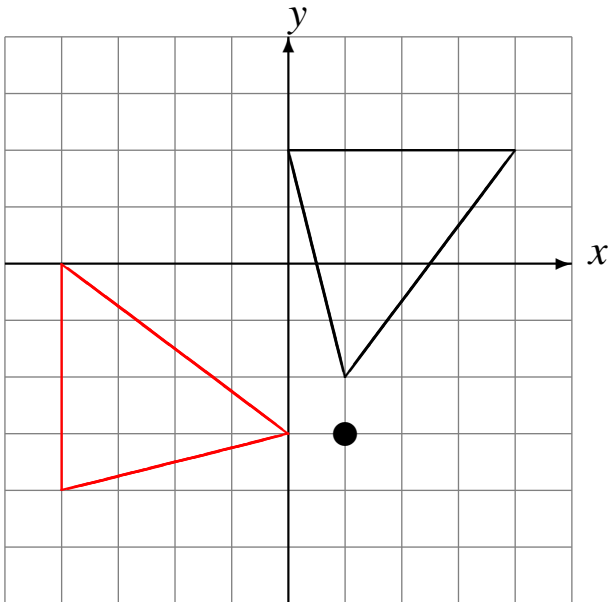

Rote -90° alrededor de $(0, 1)$.

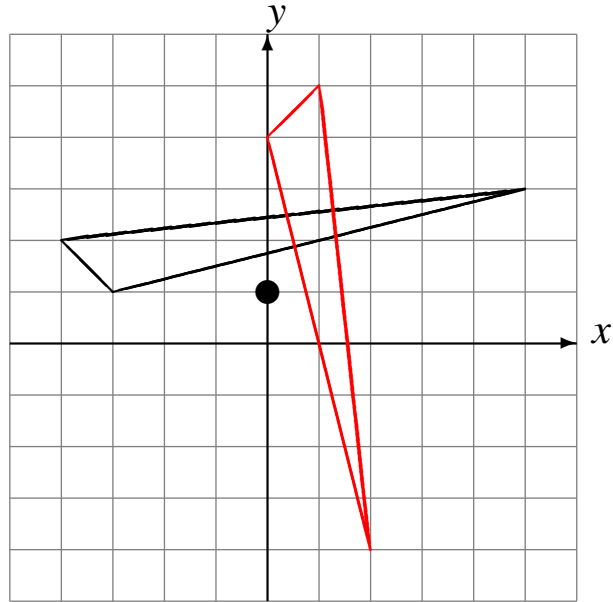

Rote -90° alrededor de $(-3, 3)$.

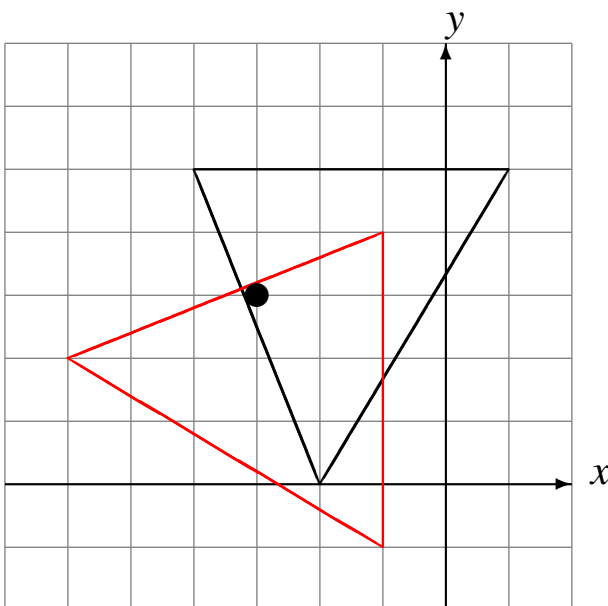

Rote 180° alrededor de $(-1, 4)$.

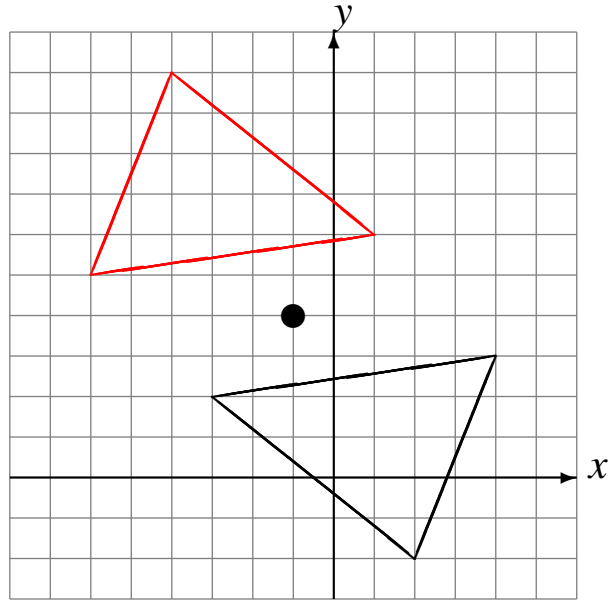

Rotaciones (B)

Dibuje cada figura rotada.

Rote -90° alrededor de $(3, -1)$.

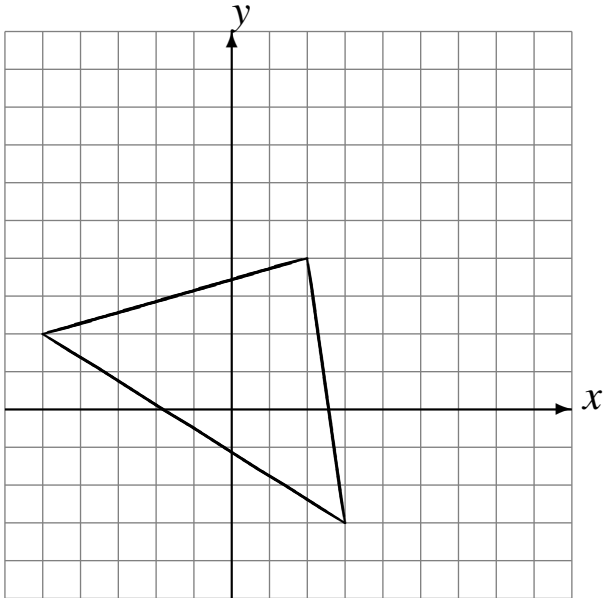

Rote 180° alrededor de $(1, -4)$.

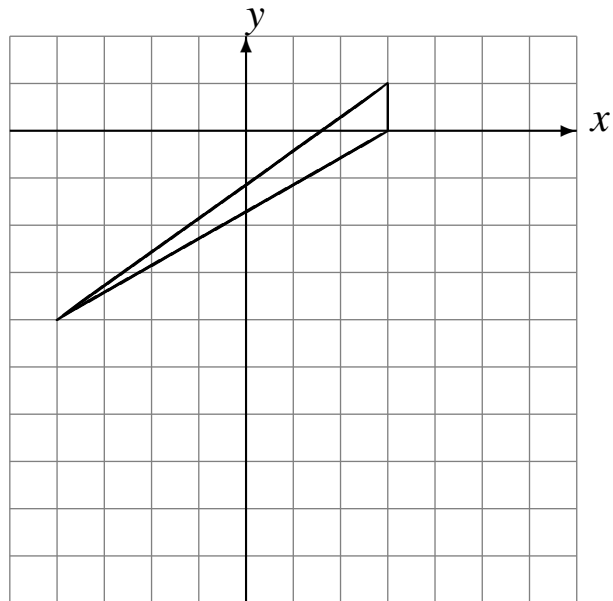

Rote 180° alrededor de $(-1, 0)$.

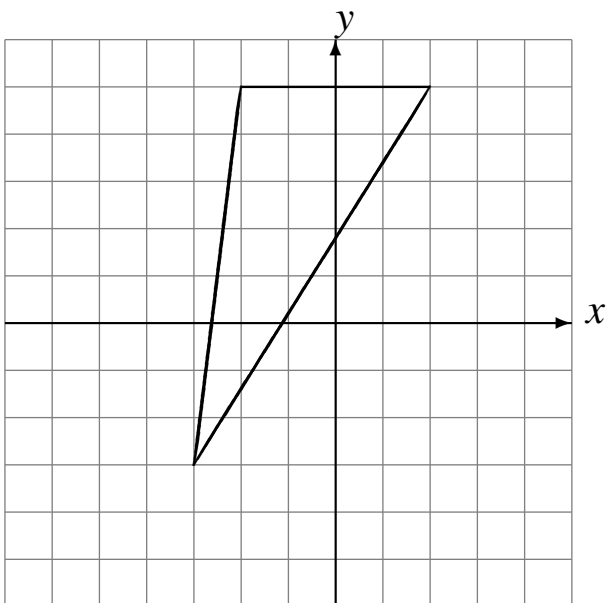

Rote -90° alrededor de $(3, -1)$.

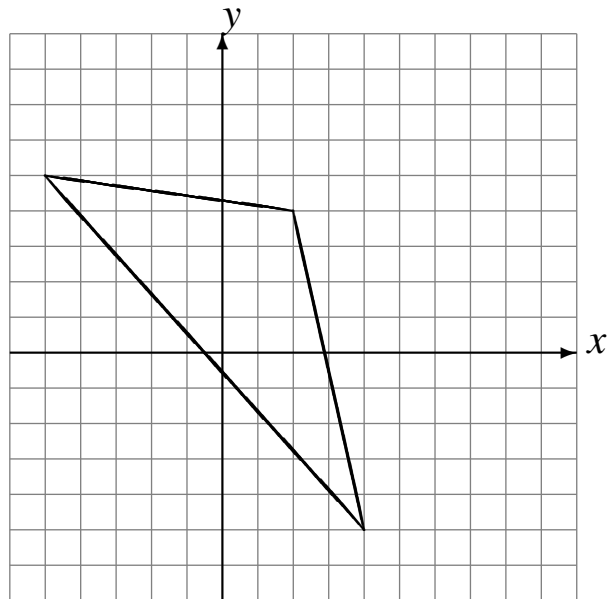

Rotaciones (B) Respuestas

Dibuje cada figura rotada.

Rote -90° alrededor de $(3, -1)$.

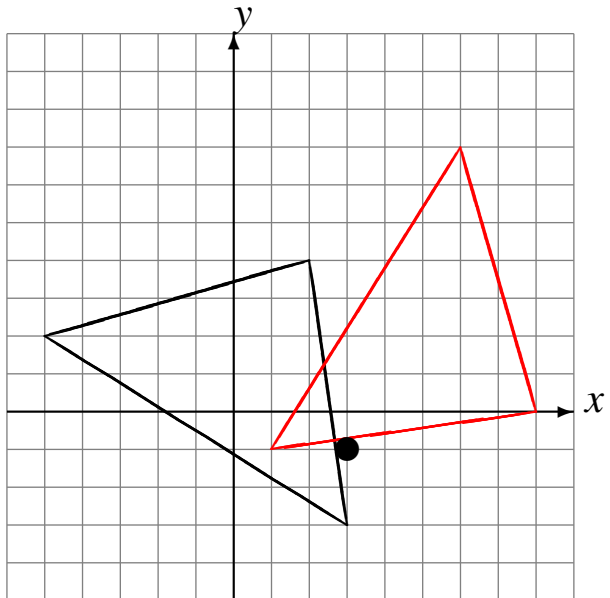

Rote 180° alrededor de $(1, -4)$.

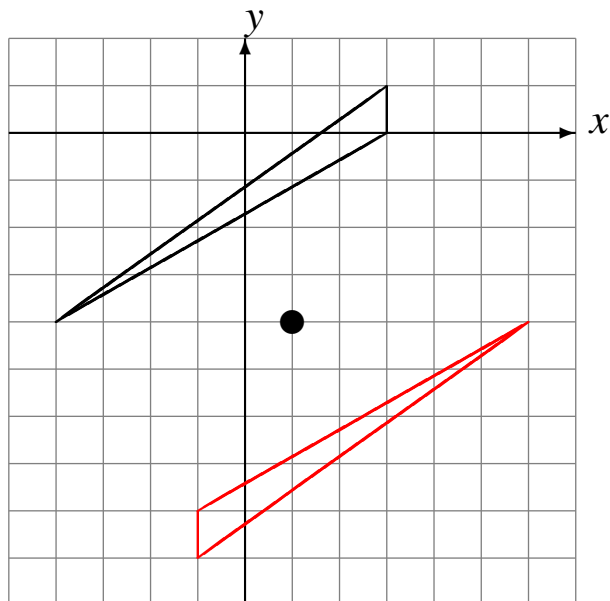

Rote 180° alrededor de $(-1, 0)$.

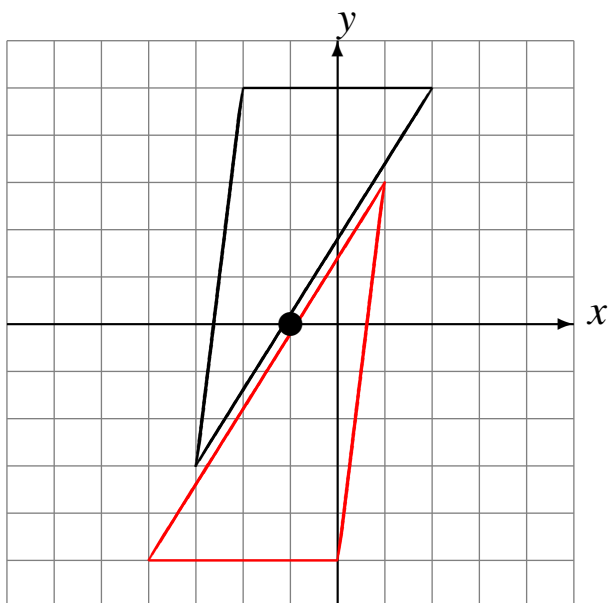

Rote -90° alrededor de $(3, -1)$.

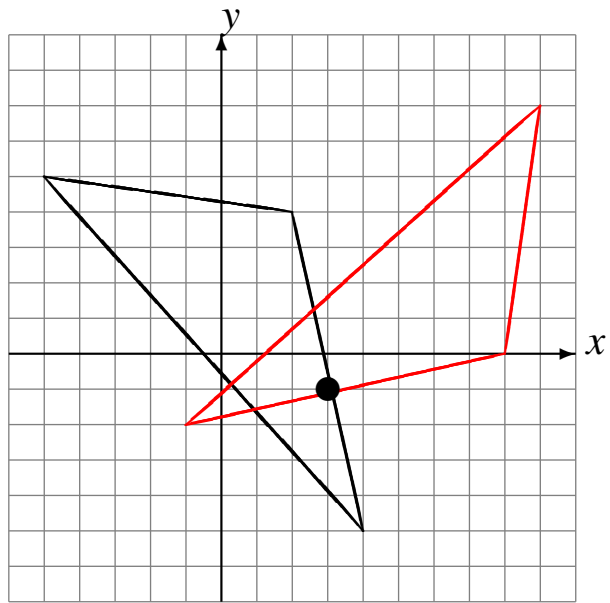

Rotaciones (C)

Dibuje cada figura rotada.

Rote -90° alrededor de $(-3, 0)$.

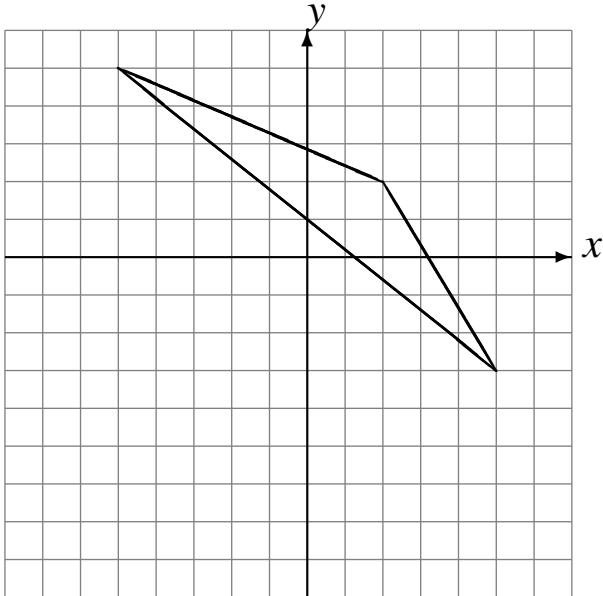

Rote -90° alrededor de $(4, -1)$.

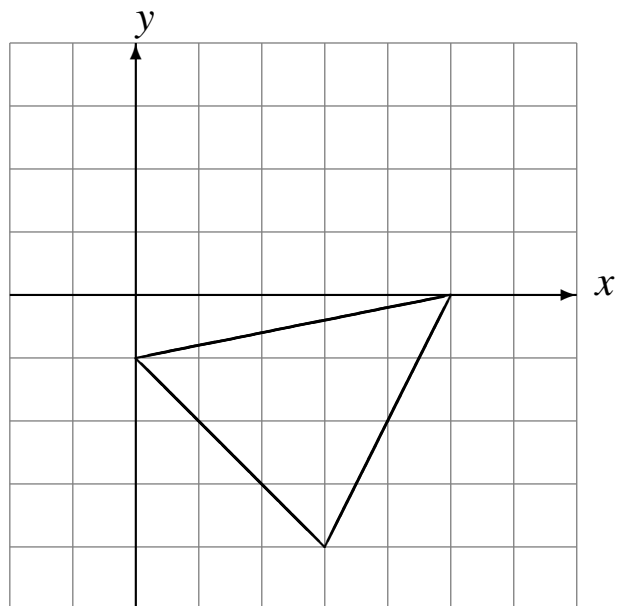

Rote 180° alrededor de $(1, -3)$.

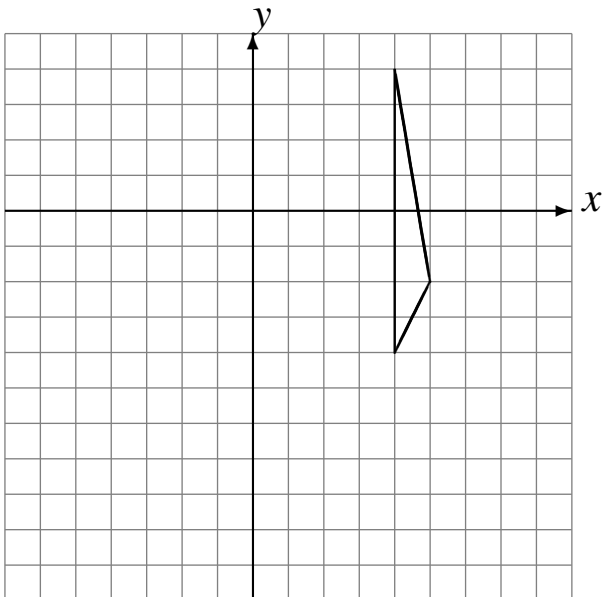

Rote -90° alrededor de $(3, 2)$.

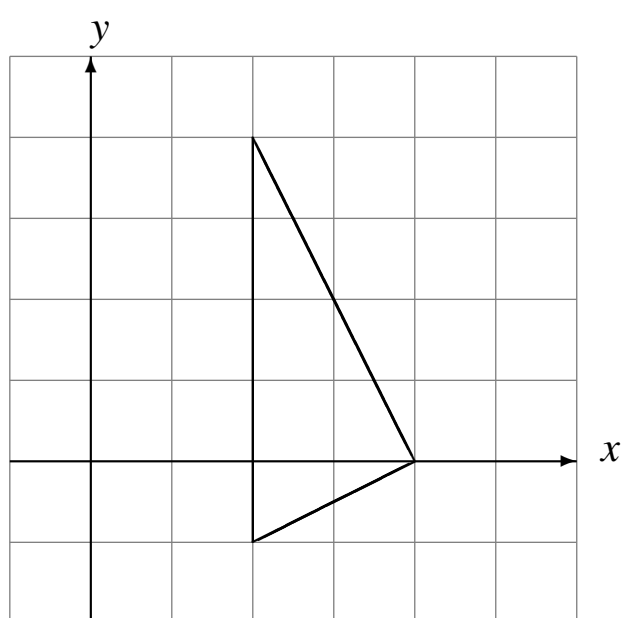

Rotaciones (C) Respuestas

Dibuje cada figura rotada.

Rote -90° alrededor de $(-3, 0)$.

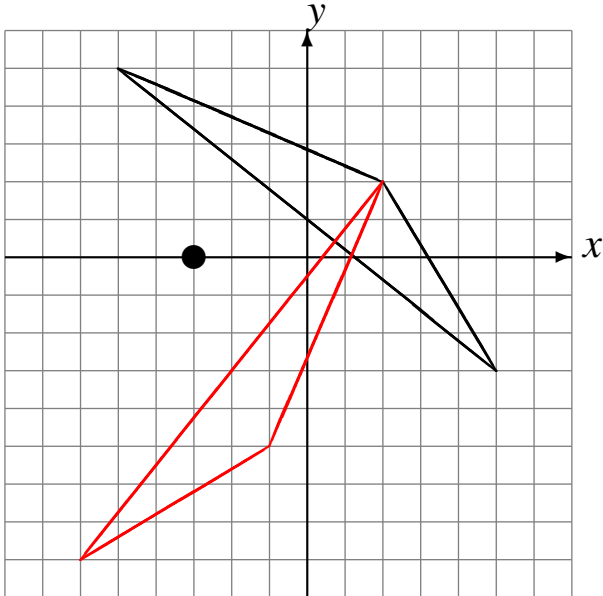

Rote -90° alrededor de $(4, -1)$.

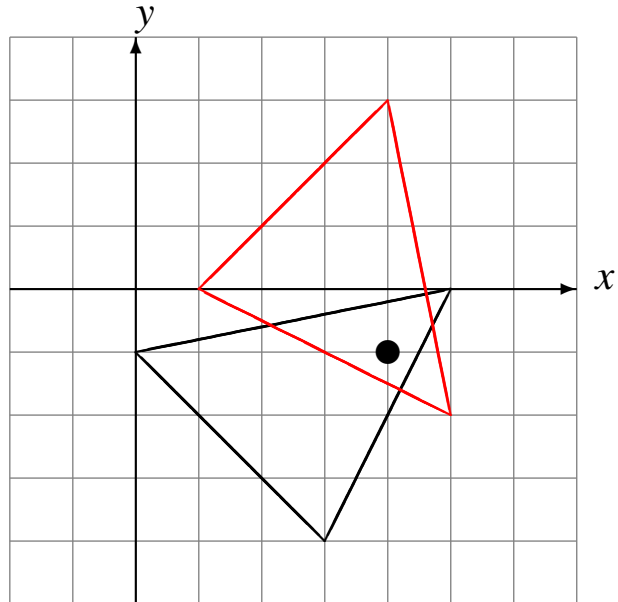

Rote 180° alrededor de $(1, -3)$.

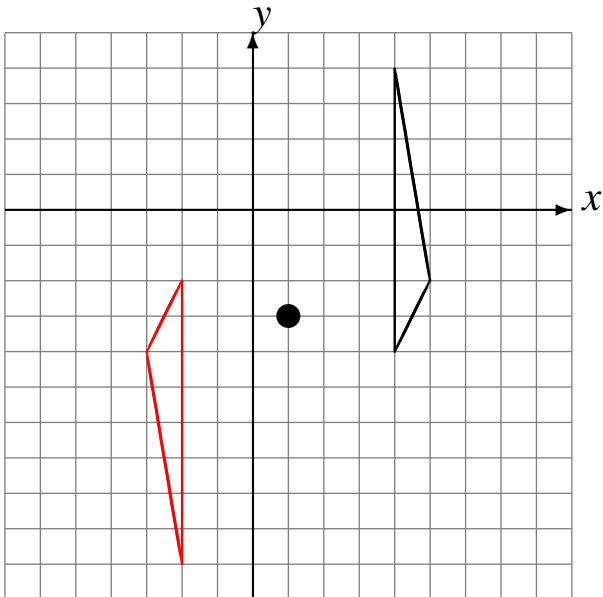

Rote -90° alrededor de $(3, 2)$.

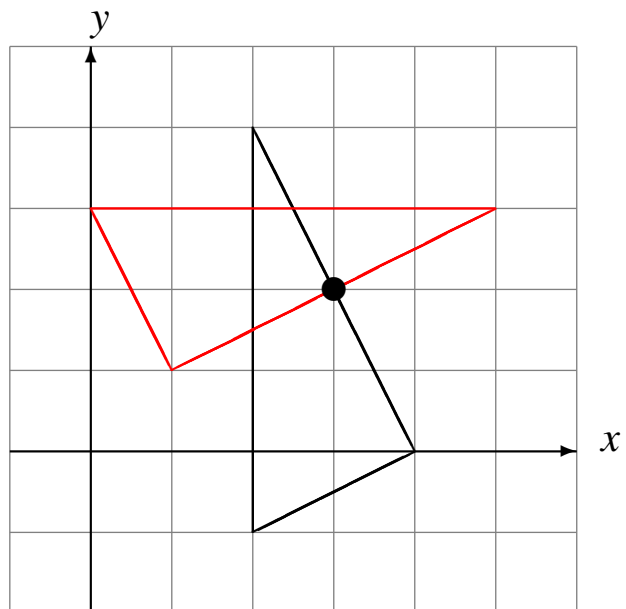

Rotaciones (D)

Dibuje cada figura rotada.

Rote 180° alrededor de $(1, -2)$.

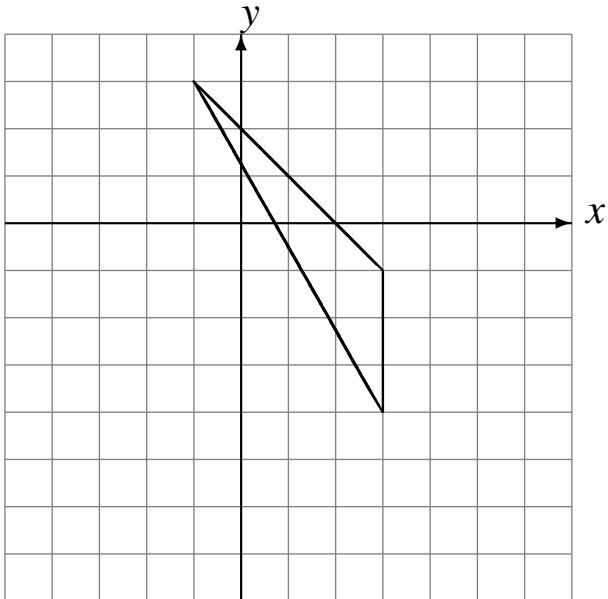

Rote 180° alrededor de $(4, -2)$.

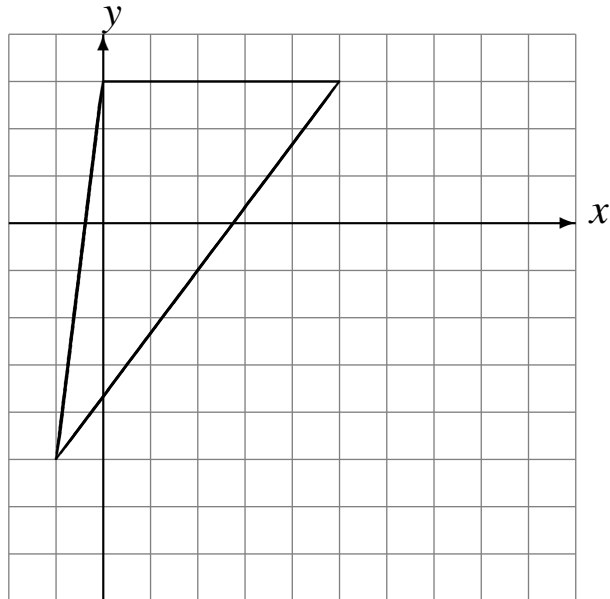

Rote 180° alrededor de $(4, -4)$.

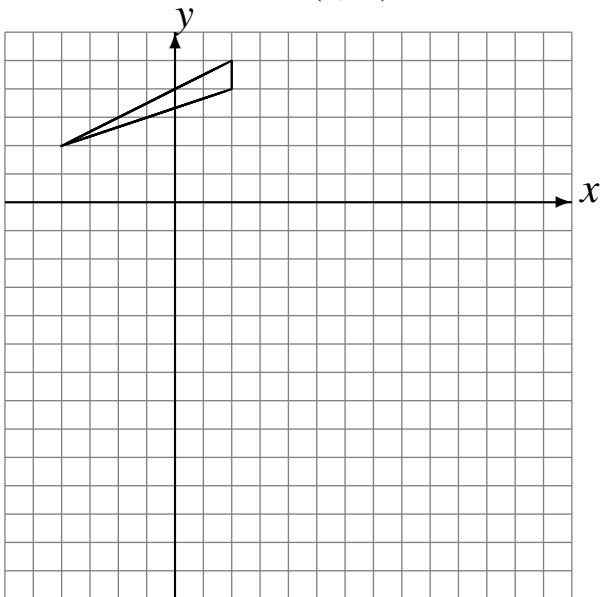

Rote 90° alrededor de $(3, 3)$.

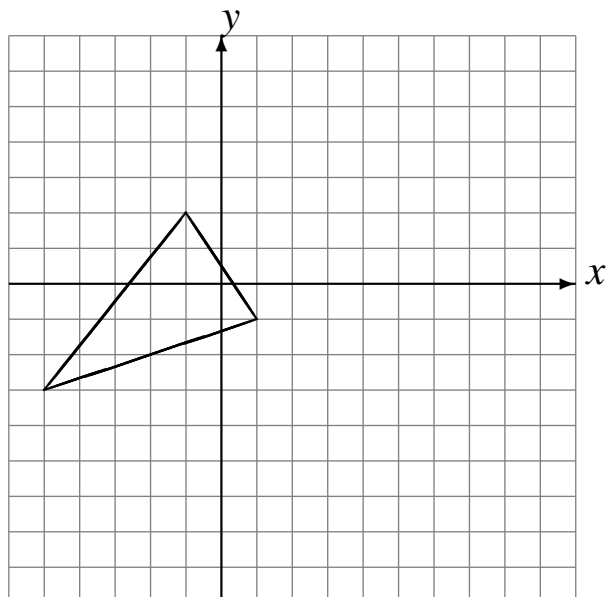

Rotaciones (D) Respuestas

Dibuje cada figura rotada.

Rote 180° alrededor de $(1, -2)$.

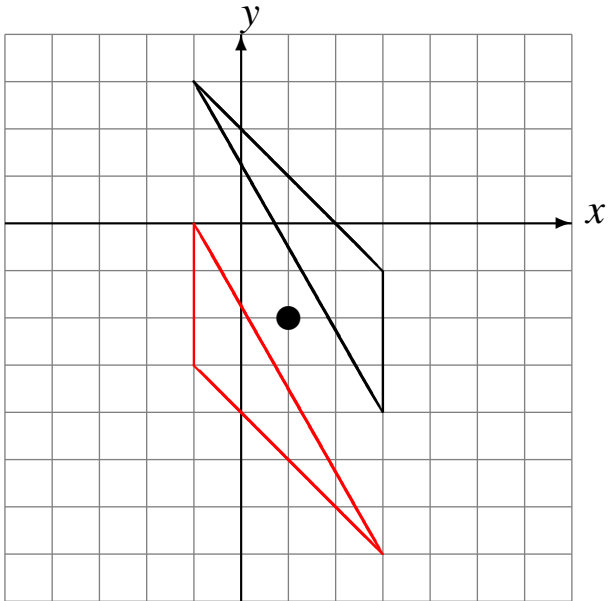

Rote 180° alrededor de $(4, -2)$.

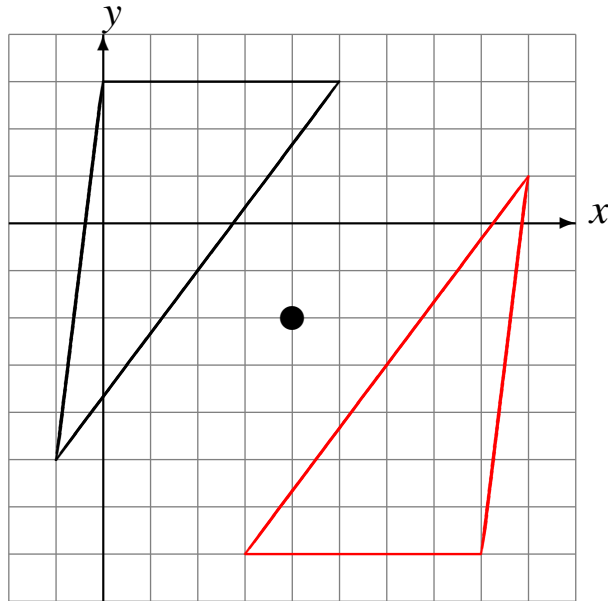

Rote 180° alrededor de $(4, -4)$.

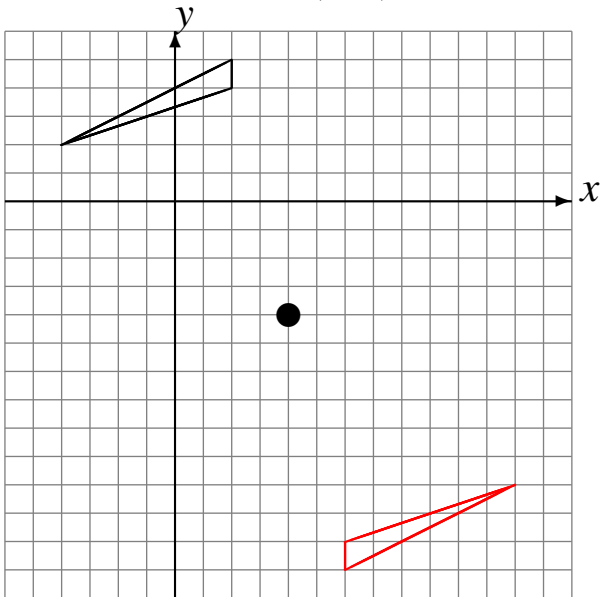

Rote 90° alrededor de $(3, 3)$.

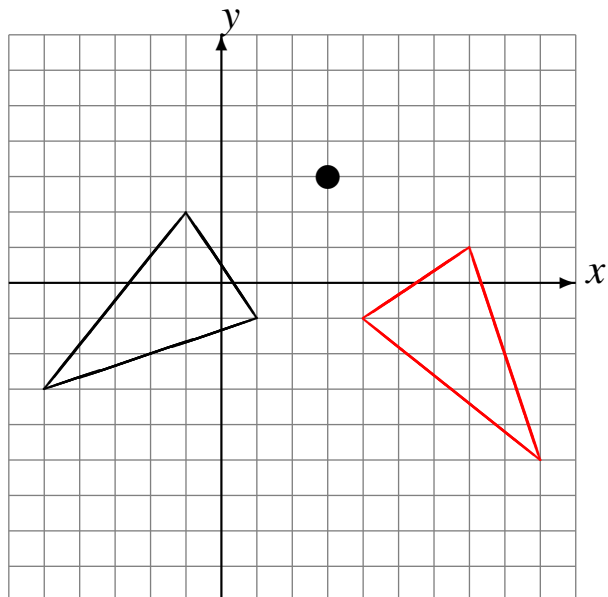

Rotaciones (E)

Dibuje cada figura rotada.

Rote 180° alrededor de $(-1, 1)$.

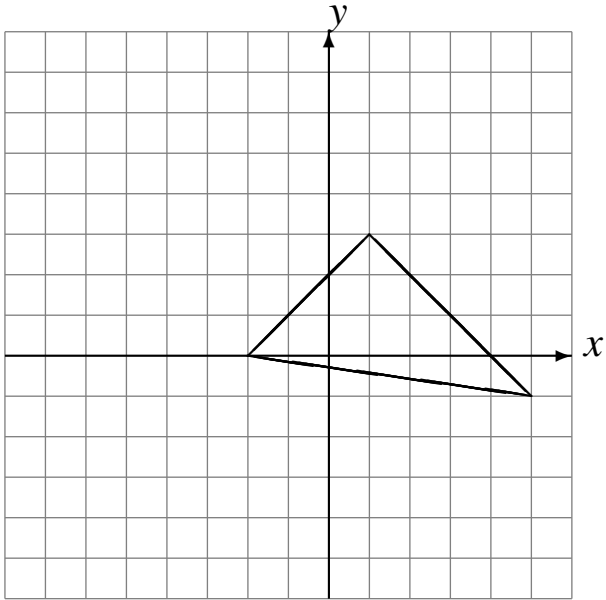

Rote 90° alrededor de $(2, 1)$.

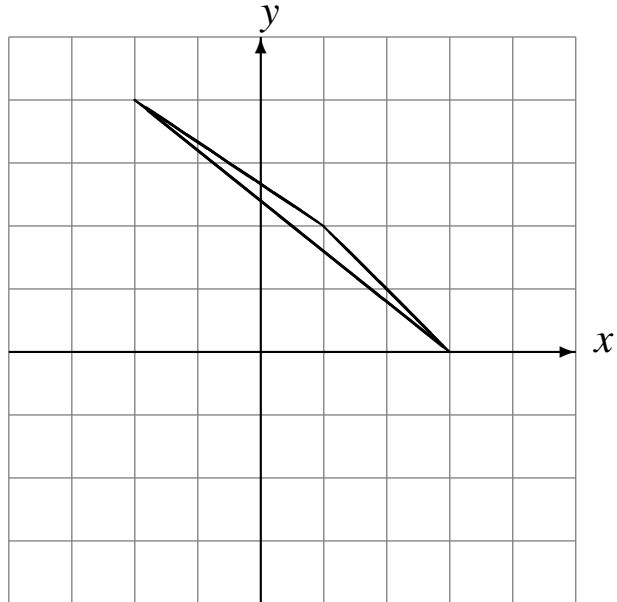

Rote 90° alrededor de $(2, -4)$.

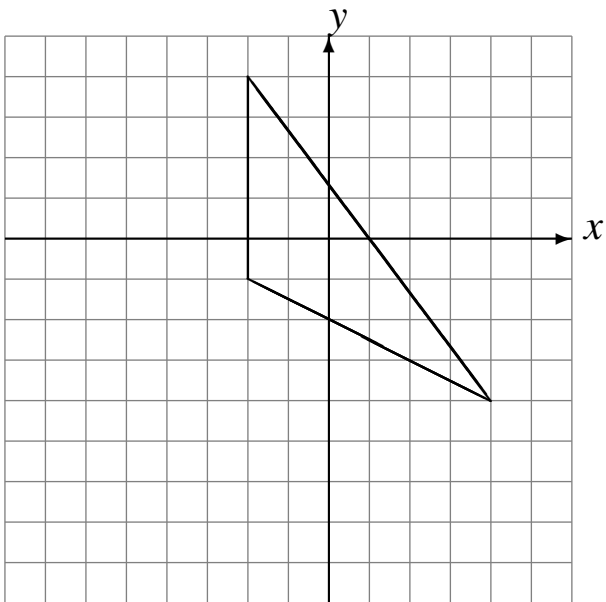

Rote 180° alrededor de $(-4, 4)$.

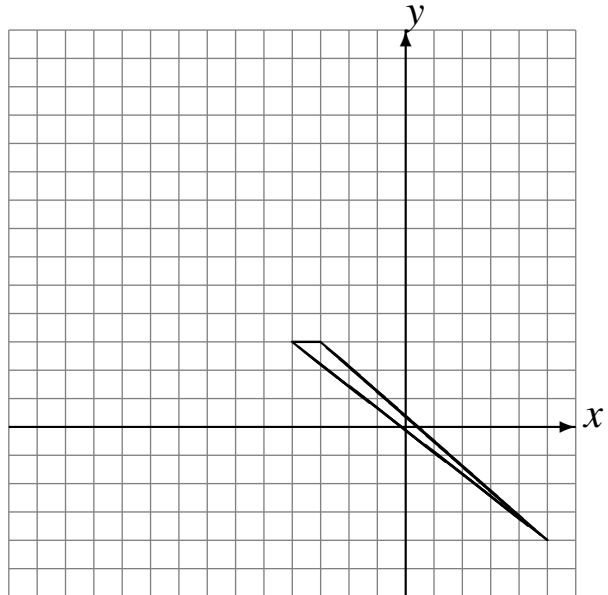

Rotaciones (E) Respuestas

Dibuje cada figura rotada.

Rote 180° alrededor de $(-1, 1)$.

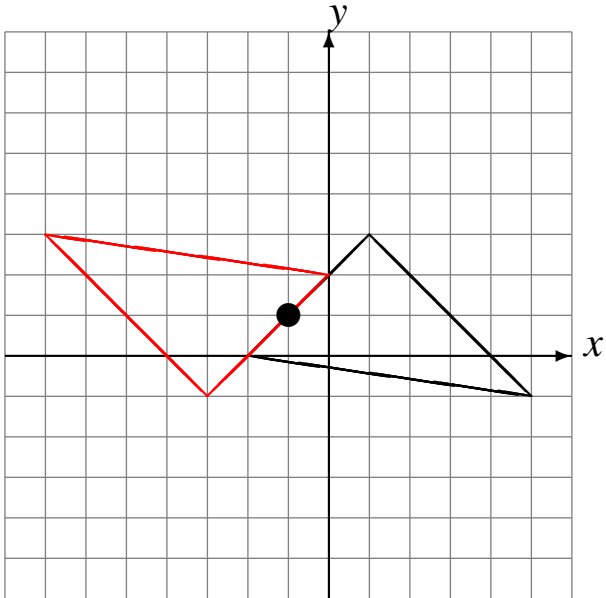

Rote 90° alrededor de $(2, 1)$.

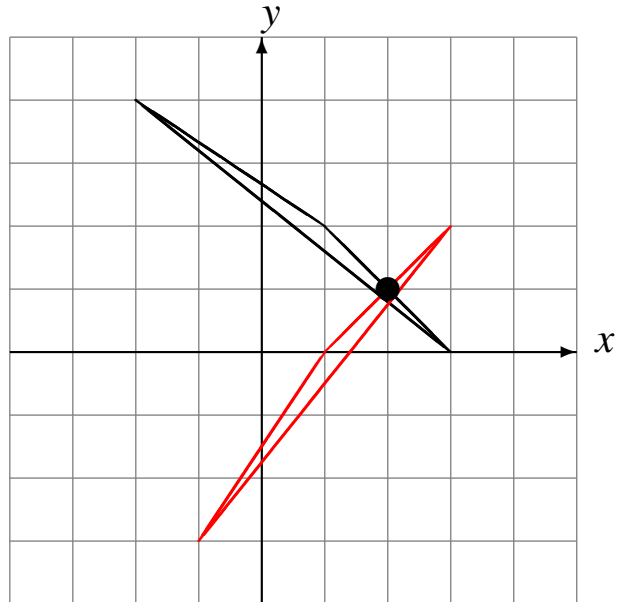

Rote 90° alrededor de $(2, -4)$.

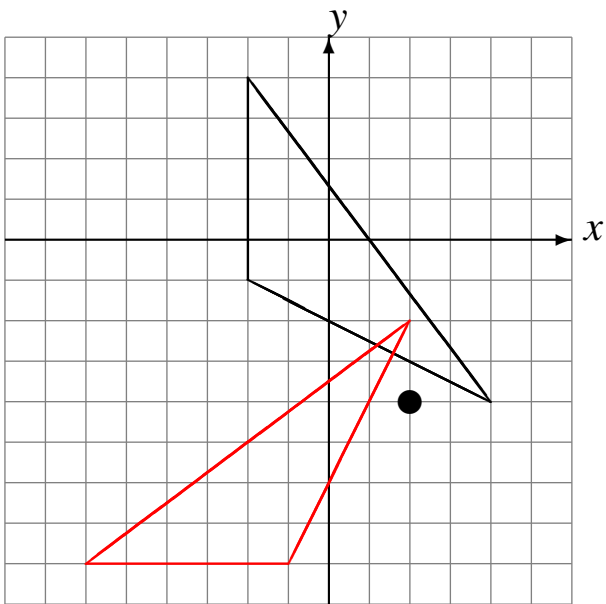

Rote 180° alrededor de $(-4, 4)$.

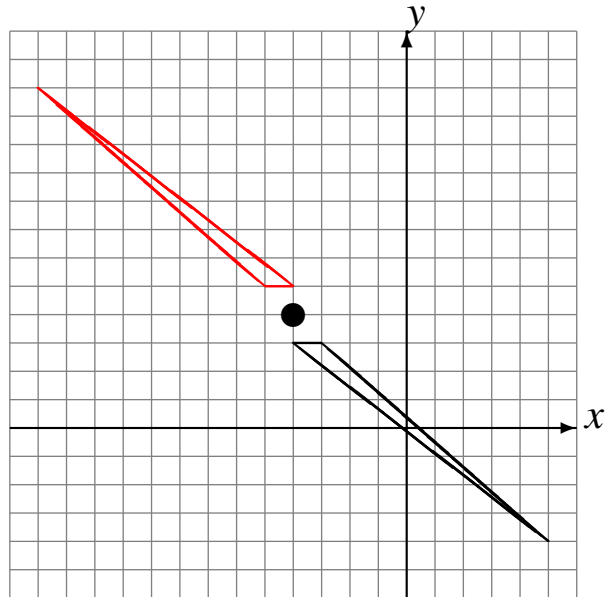

Rotaciones (F)

Dibuje cada figura rotada.

Rote 180° alrededor de $(-1, -1)$.

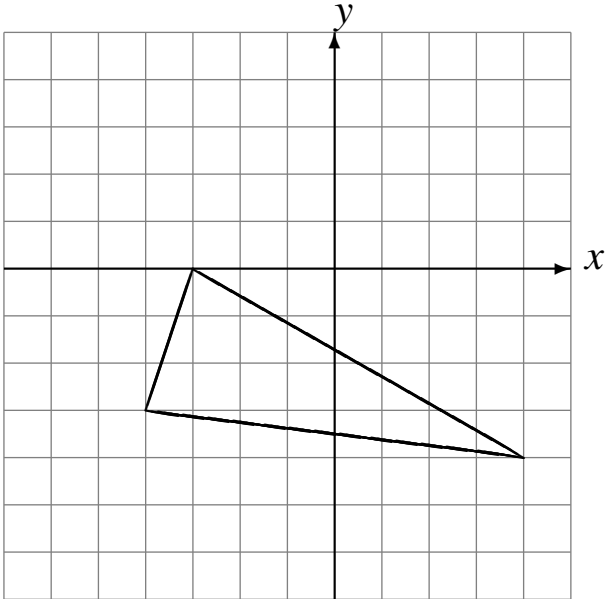

Rote -90° alrededor de $(-2, 0)$.

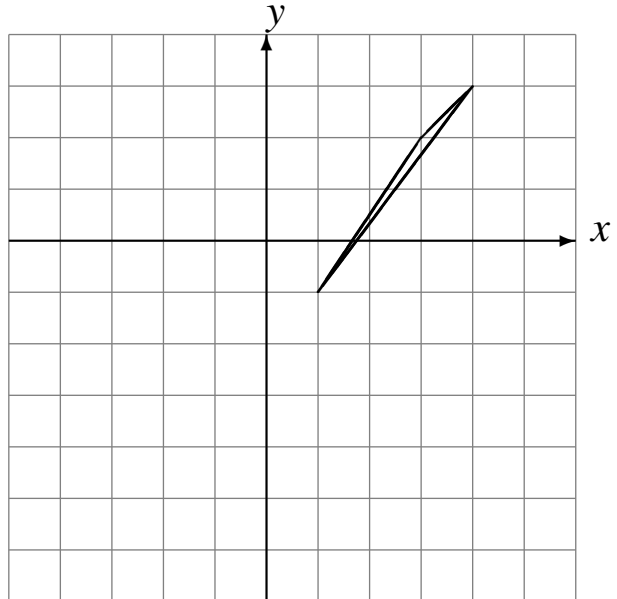

Rote 180° alrededor de $(-4, -2)$.

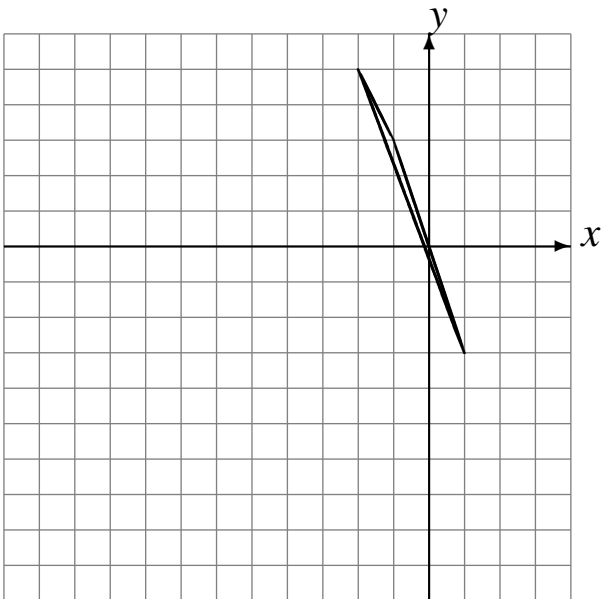

Rote 180° alrededor de $(3, 4)$.

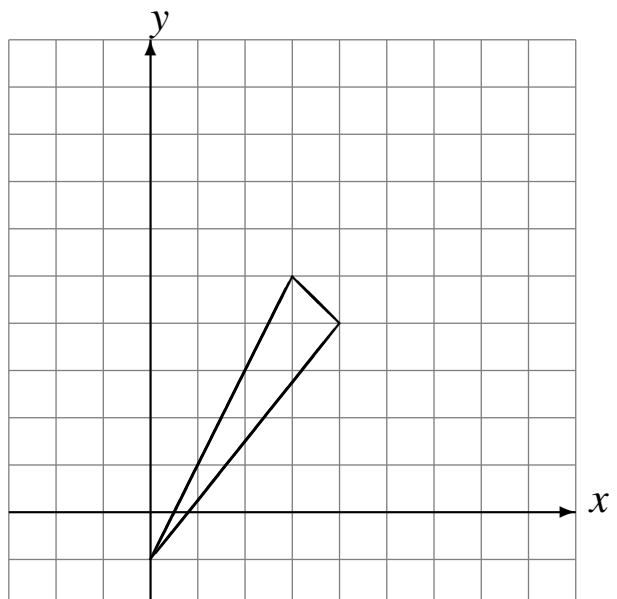

Rotaciones (F) Respuestas

Dibuje cada figura rotada.

Rote 180° alrededor de $(-1, -1)$.

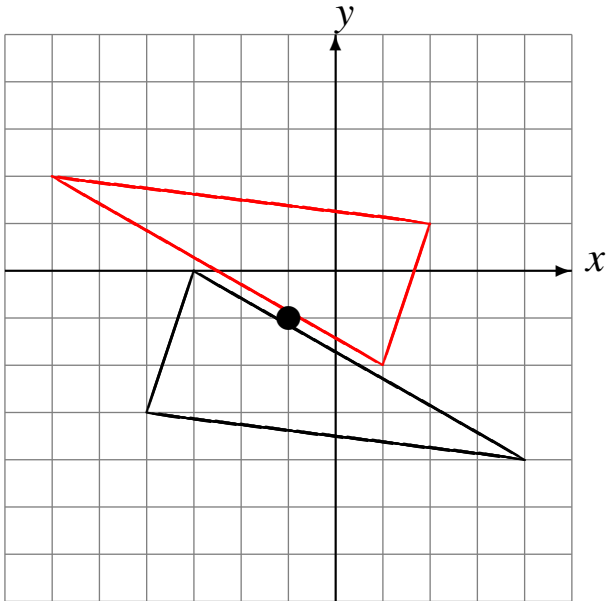

Rote -90° alrededor de $(-2, 0)$.

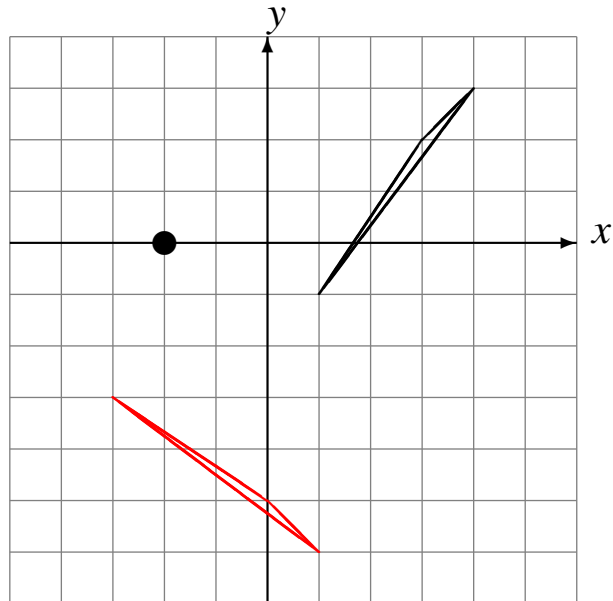

Rote 180° alrededor de $(-4, -2)$.

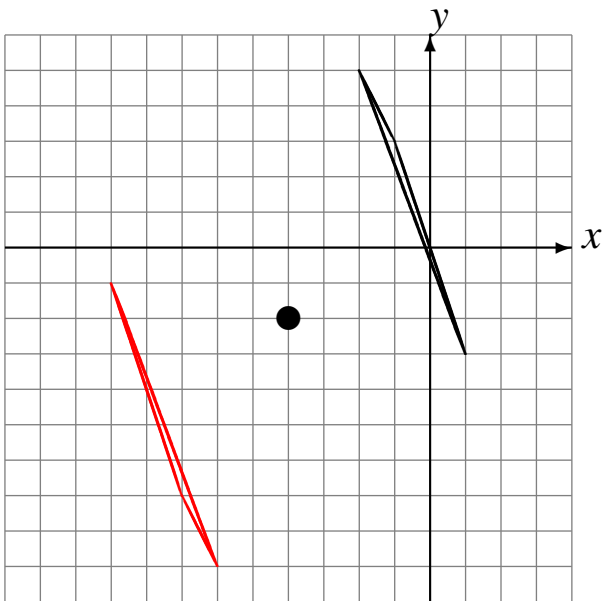

Rote 180° alrededor de $(3, 4)$.

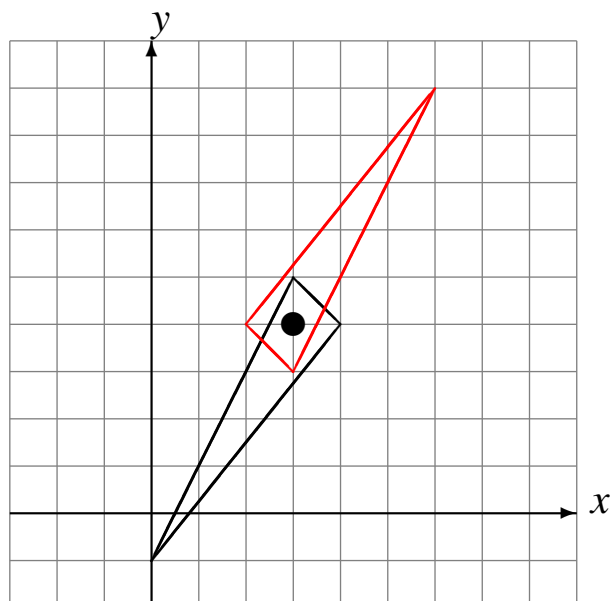

Rotaciones (G)

Dibuje cada figura rotada.

Rote -90° alrededor de $(0, -3)$.

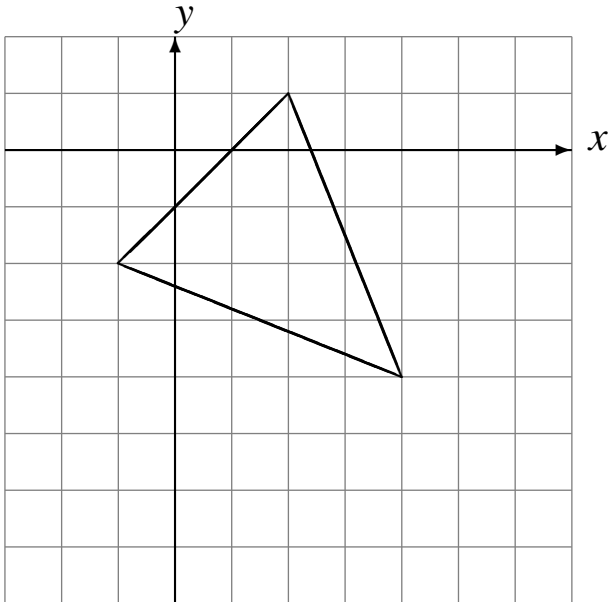

Rote -90° alrededor de $(3, 0)$.

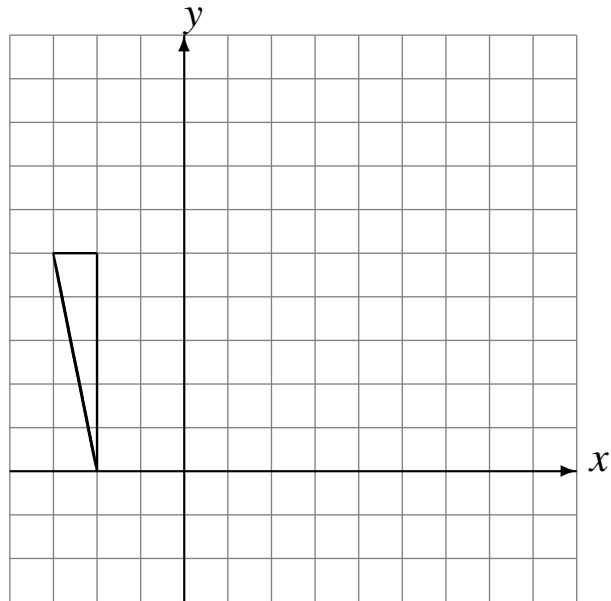

Rote 90° alrededor de $(-3, 3)$.

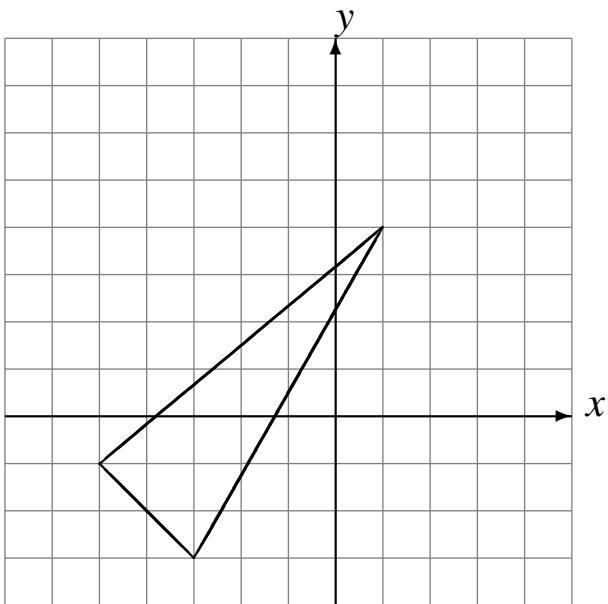

Rote 180° alrededor de $(3, -1)$.

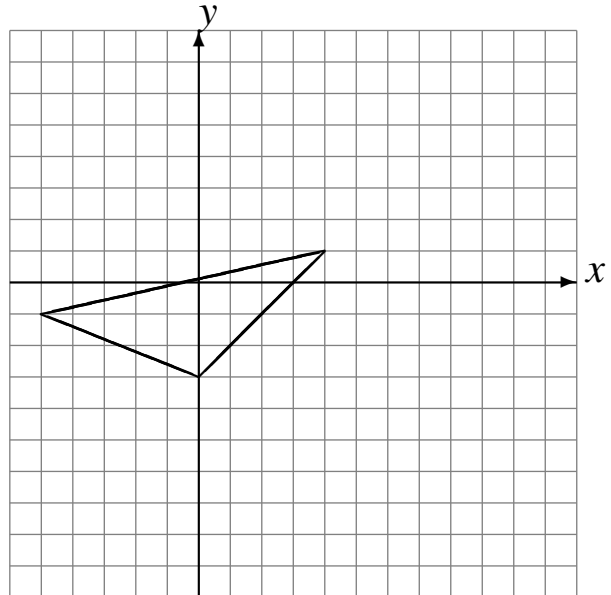

Rotaciones (G) Respuestas

Dibuje cada figura rotada.

Rote -90° alrededor de $(0, -3)$.

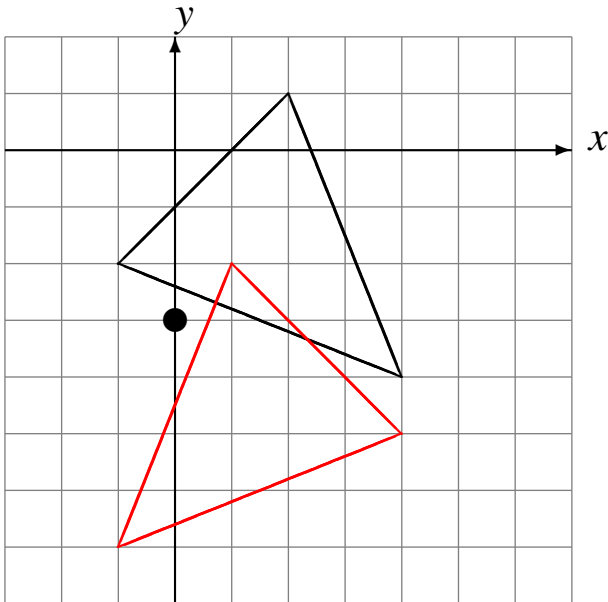

Rote -90° alrededor de $(3, 0)$.

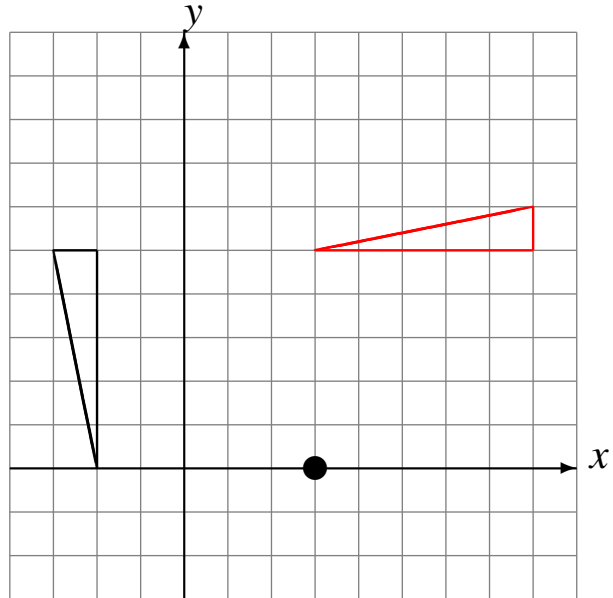

Rote 90° alrededor de $(-3, 3)$.

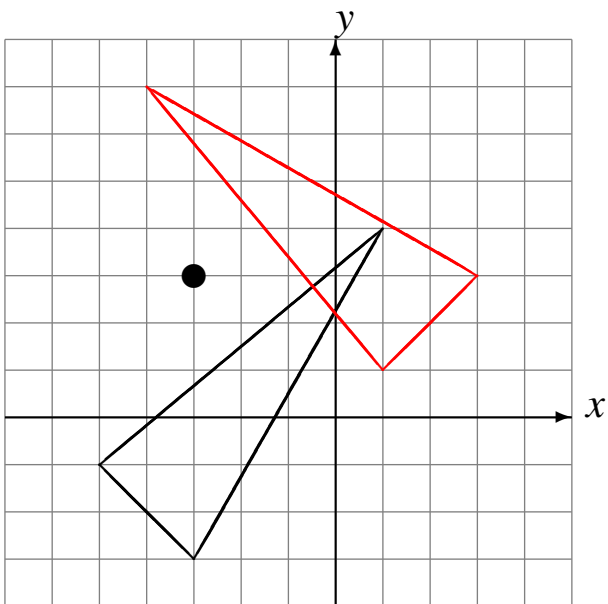

Rote 180° alrededor de $(3, -1)$.

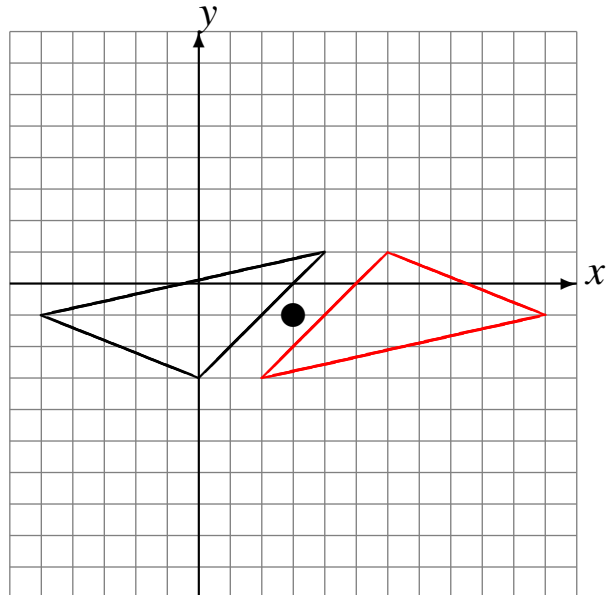

Rotaciones (H)

Dibuje cada figura rotada.

Rote 180° alrededor de $(1, -2)$.

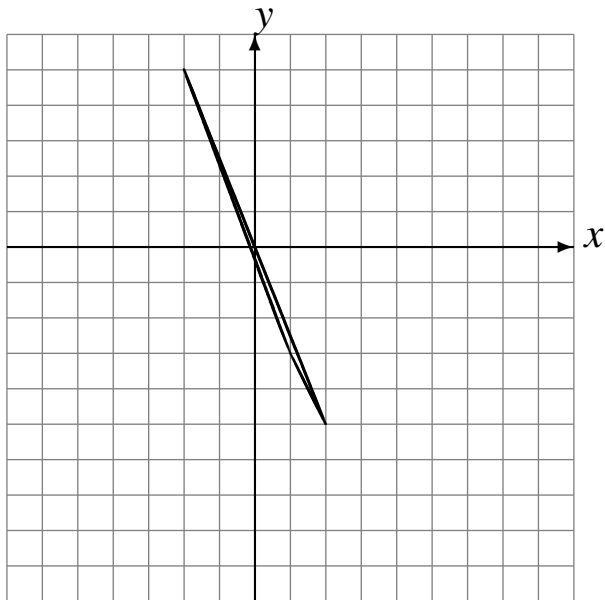

Rote -90° alrededor de $(-3, -3)$.

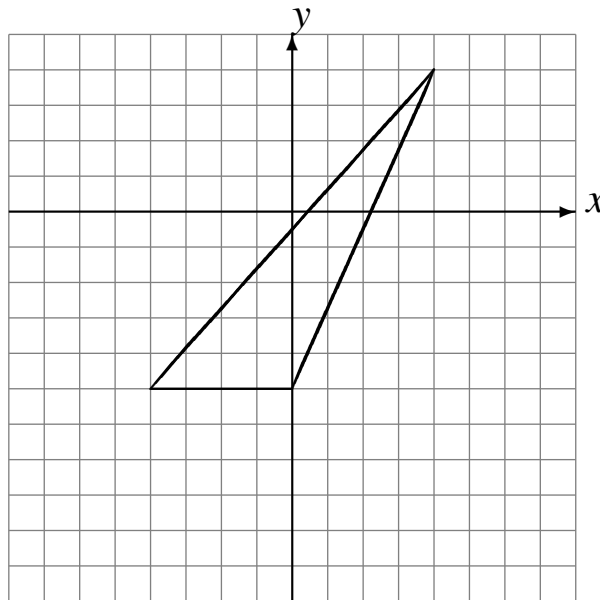

Rote -90° alrededor de $(1, 0)$.

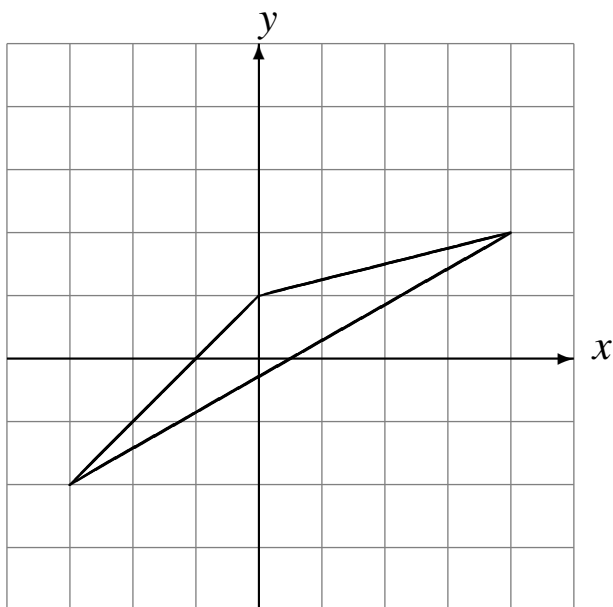

Rote -90° alrededor de $(-3, -2)$.

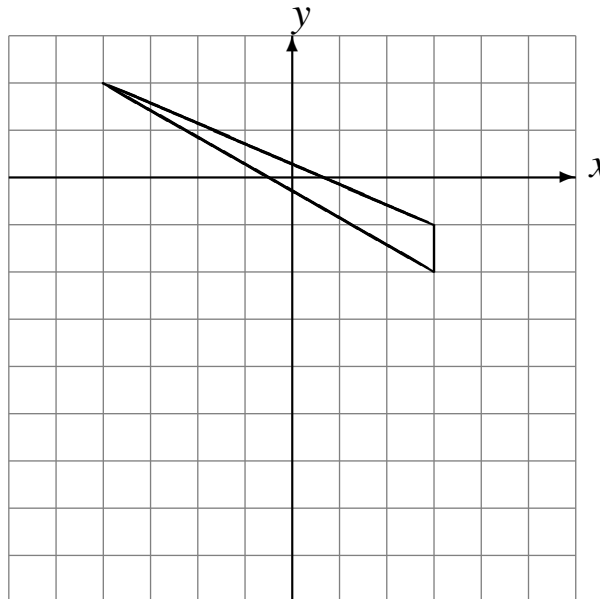

Rotaciones (H) Respuestas

Dibuje cada figura rotada.

Rote 180° alrededor de $(1, -2)$.

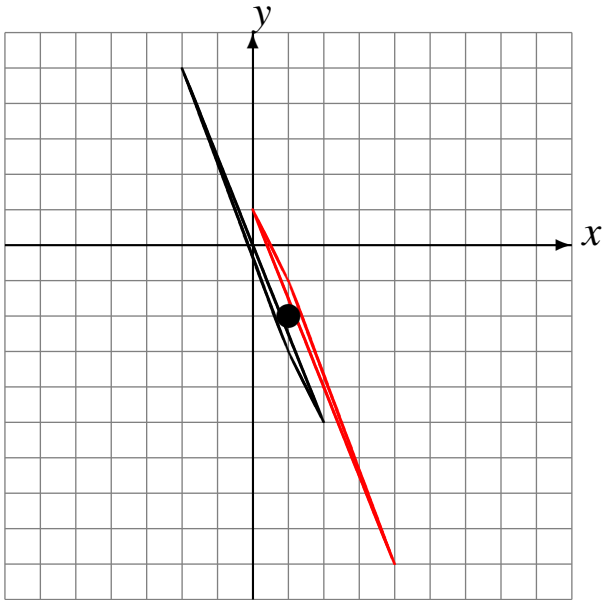

Rote -90° alrededor de $(-3, -3)$.

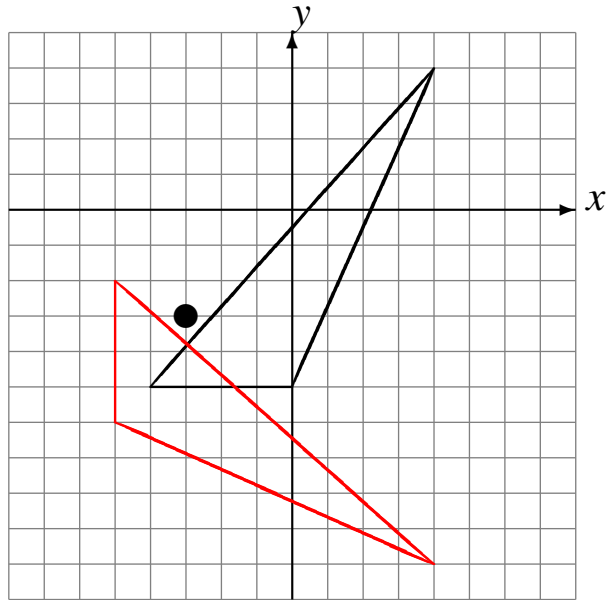

Rote -90° alrededor de $(1, 0)$.

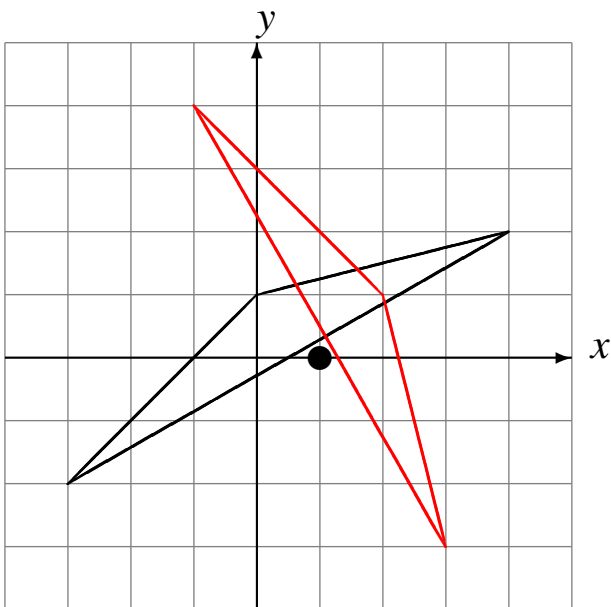

Rote -90° alrededor de $(-3, -2)$.

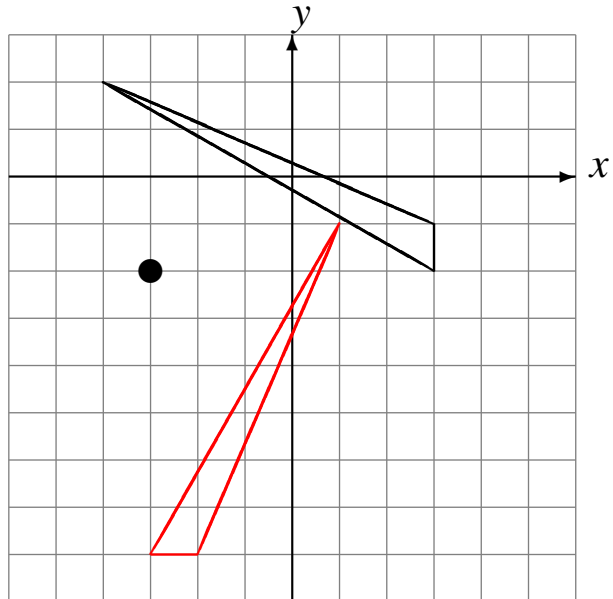

Rotaciones (I)

Dibuje cada figura rotada.

Rote 180° alrededor de $(4, 3)$.

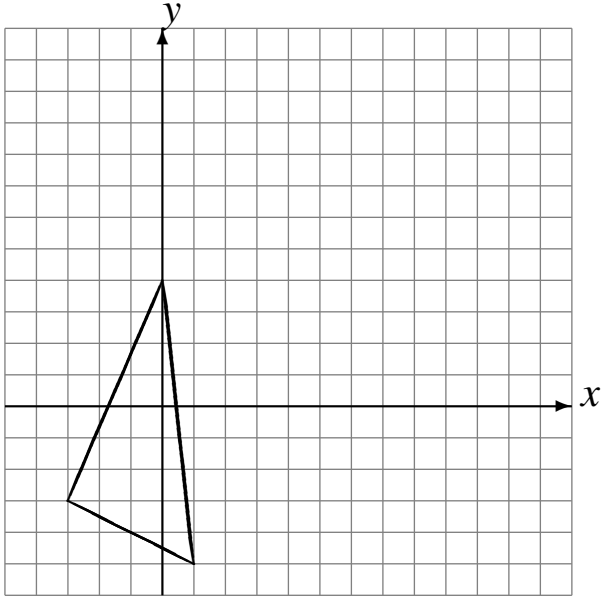

Rote -90° alrededor de $(1, -4)$.

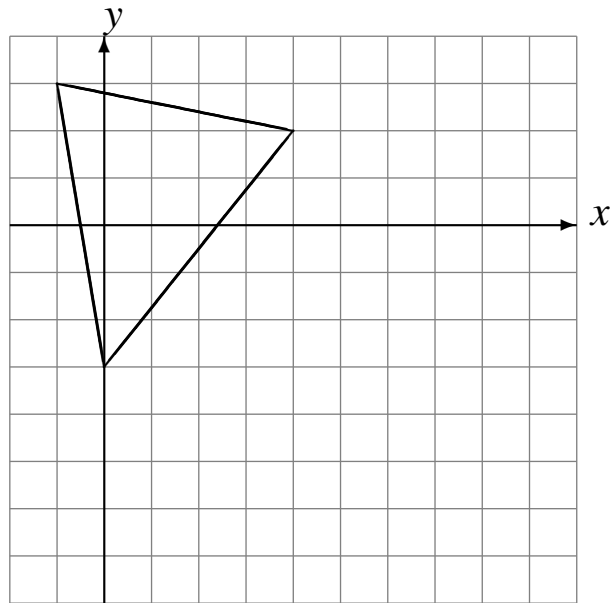

Rote -90° alrededor de $(-4, 4)$.

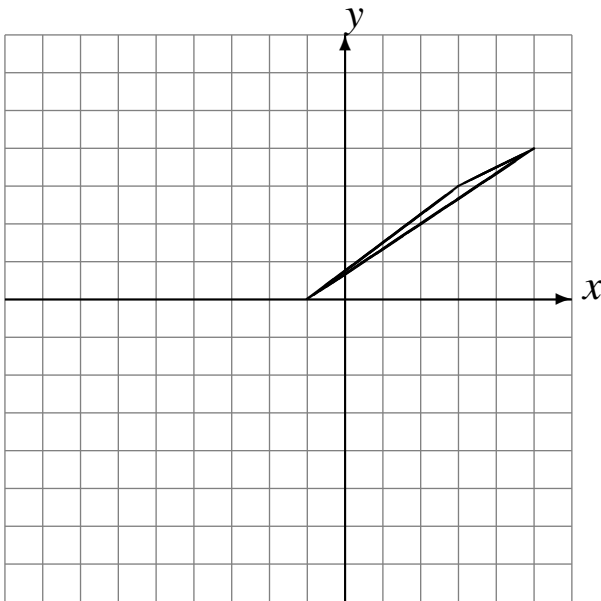

Rote -90° alrededor de $(-1, -2)$.

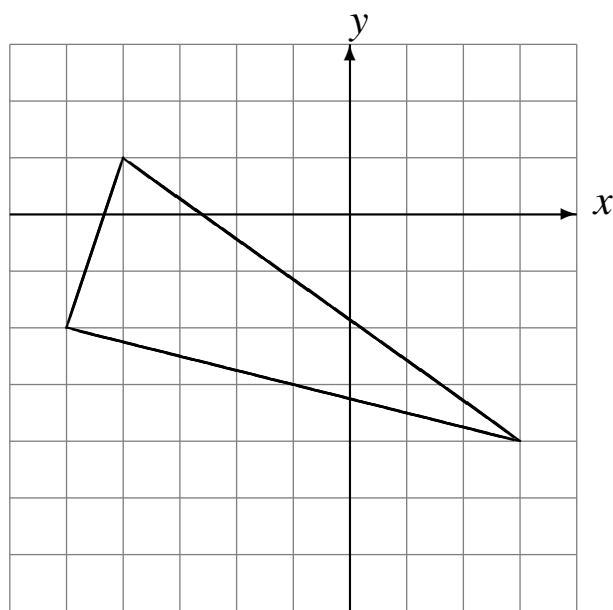

Rotaciones (I) Respuestas

Dibuje cada figura rotada.

Rote 180° alrededor de $(4, 3)$.

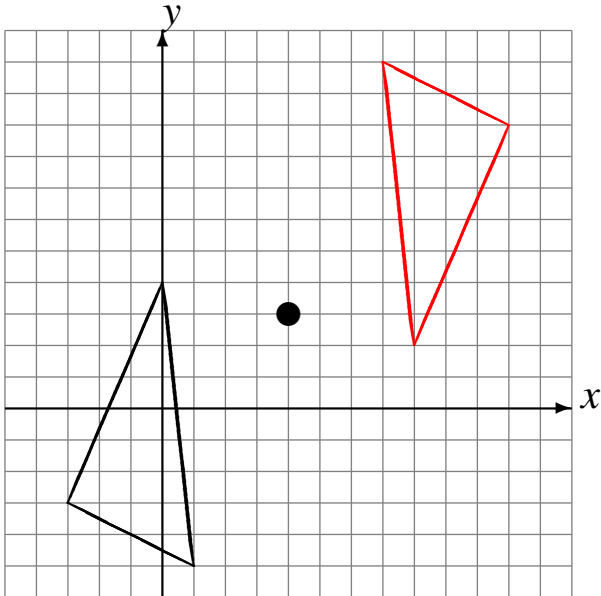

Rote -90° alrededor de $(1, -4)$.

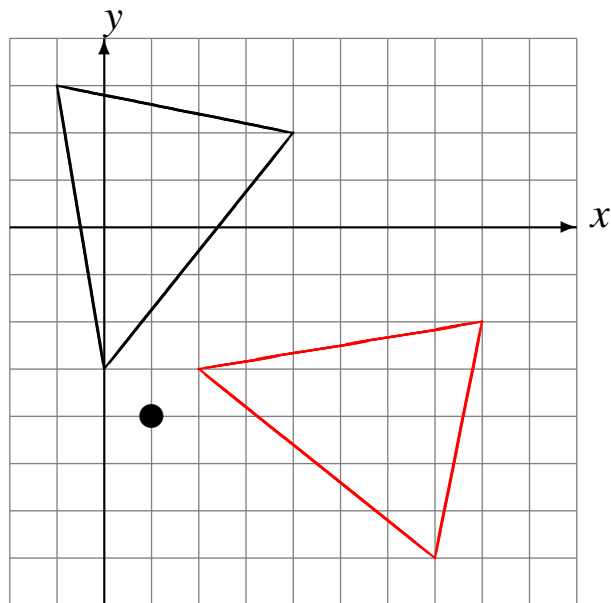

Rote -90° alrededor de $(-4, 4)$.

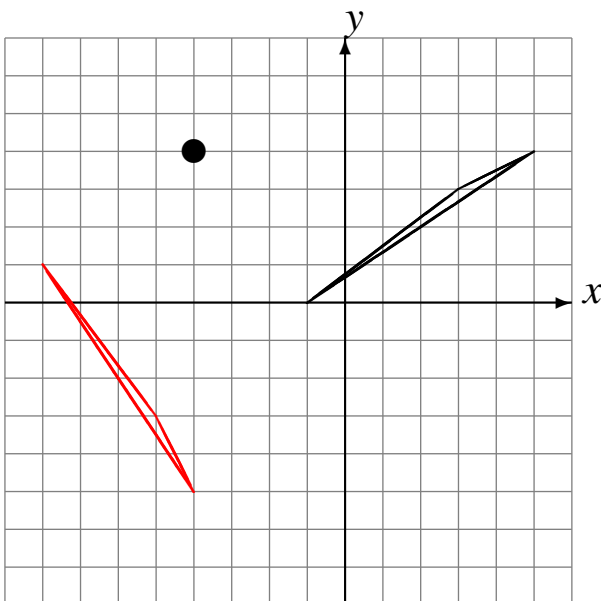

Rote -90° alrededor de $(-1, -2)$.

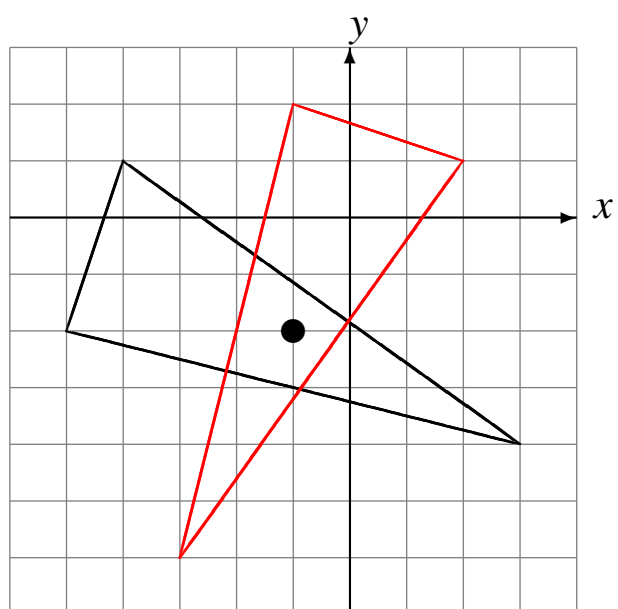

Rotaciones (J)

Dibuje cada figura rotada.

Rote 90° alrededor de $(-4, -4)$.

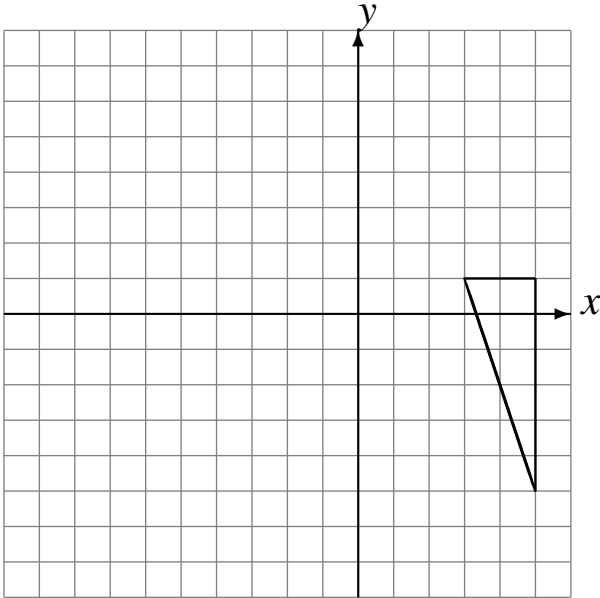

Rote 180° alrededor de $(-4, 2)$.

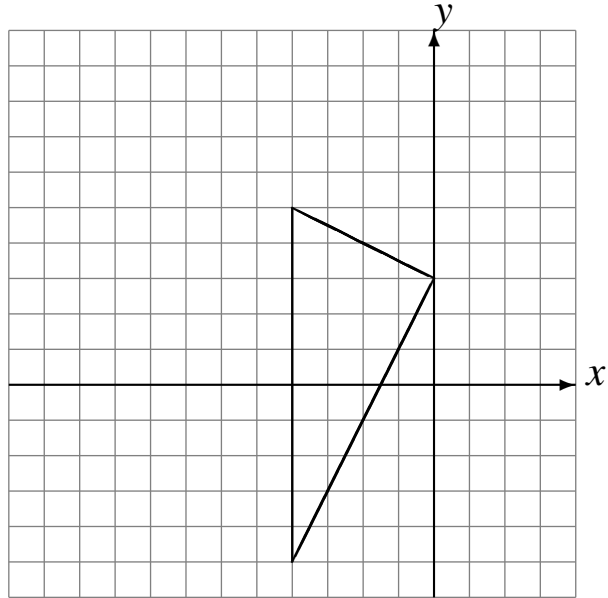

Rote 90° alrededor de $(0, 4)$.

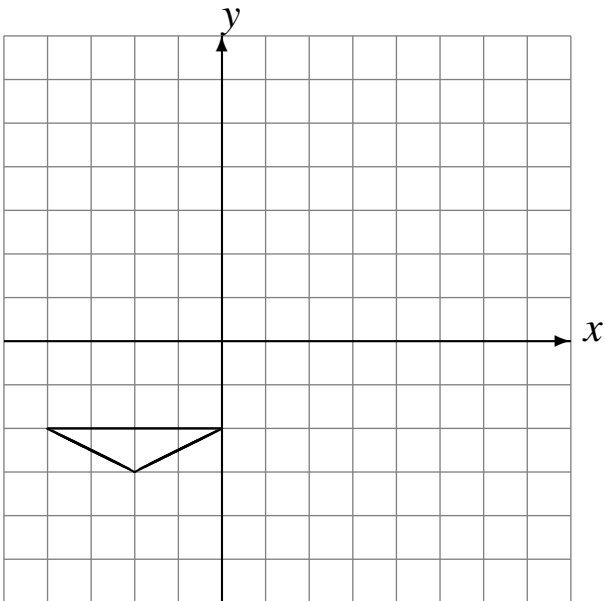

Rote -90° alrededor de $(-1, -2)$.

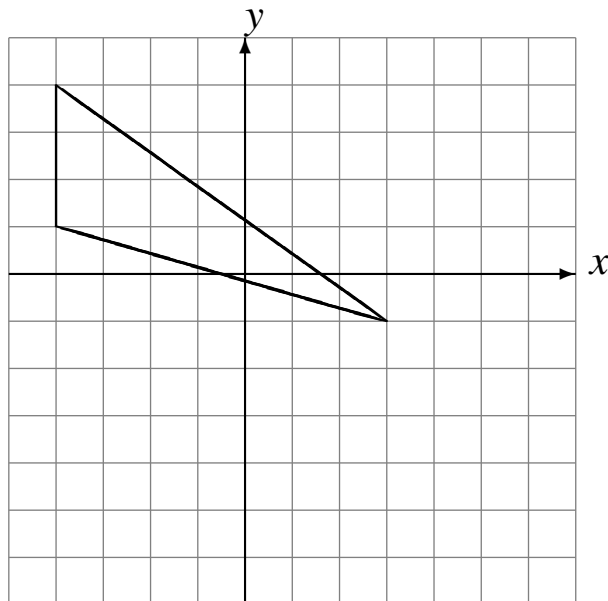

Rotaciones (J) Respuestas

Dibuje cada figura rotada.

Rote 90° alrededor de $(-4, -4)$.

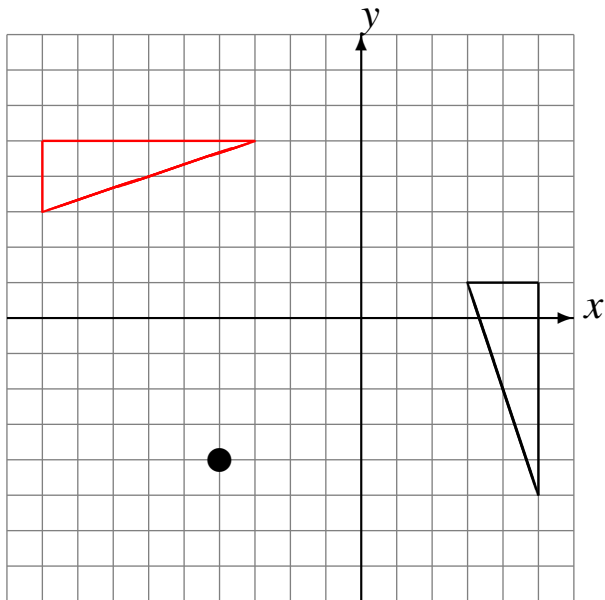

Rote 180° alrededor de $(-4, 2)$.

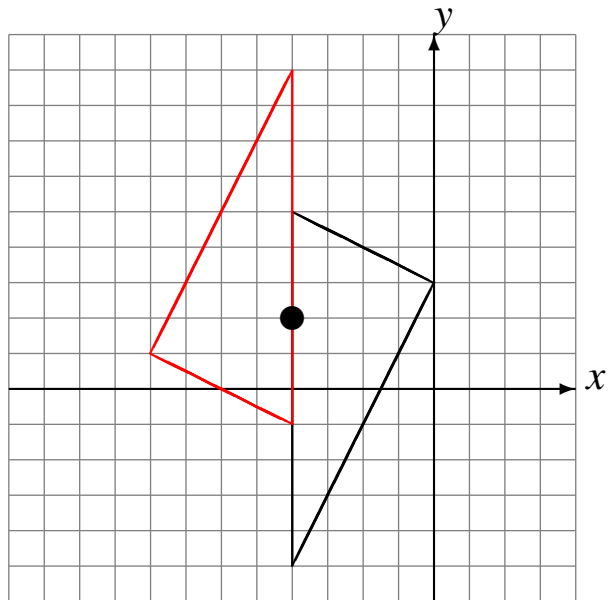

Rote 90° alrededor de $(0, 4)$.

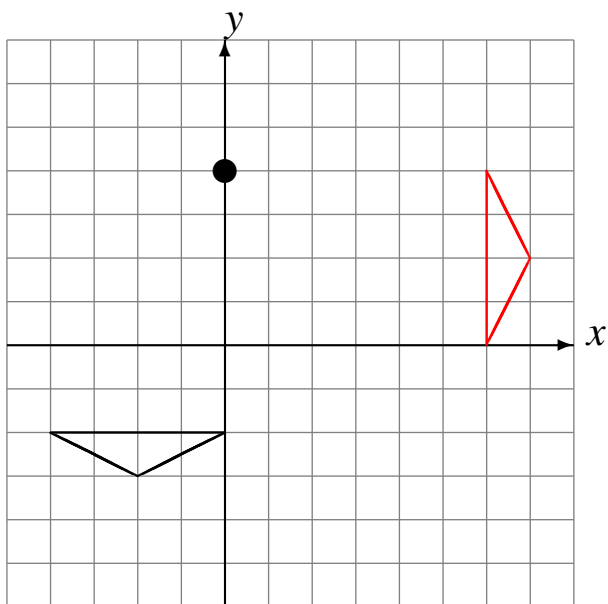

Rote -90° alrededor de $(-1, -2)$.

