

# Rotaciones (A)

Dibuje cada figura rotada.

Rote  $-90^\circ$  alrededor de  $(0, 0)$ .

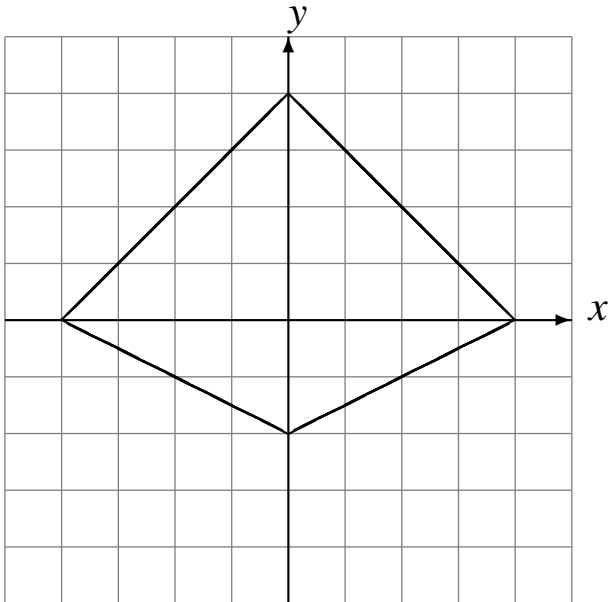

Rote  $90^\circ$  alrededor de  $(0, 0)$ .

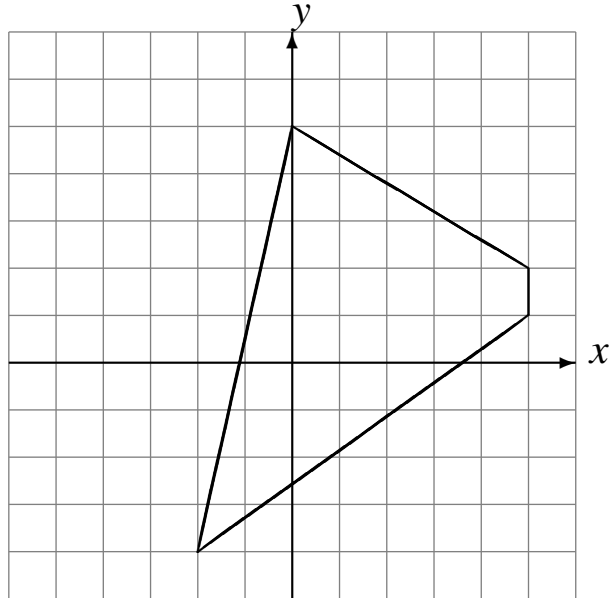

Rote  $90^\circ$  alrededor de  $(0, 0)$ .

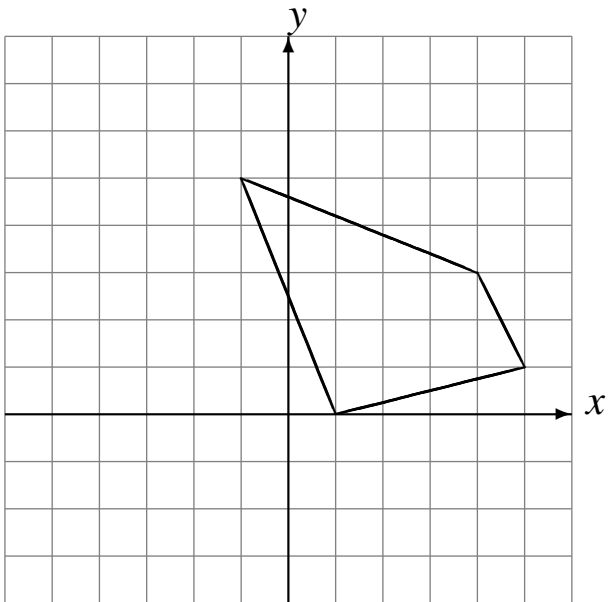

Rote  $180^\circ$  alrededor de  $(0, 0)$ .

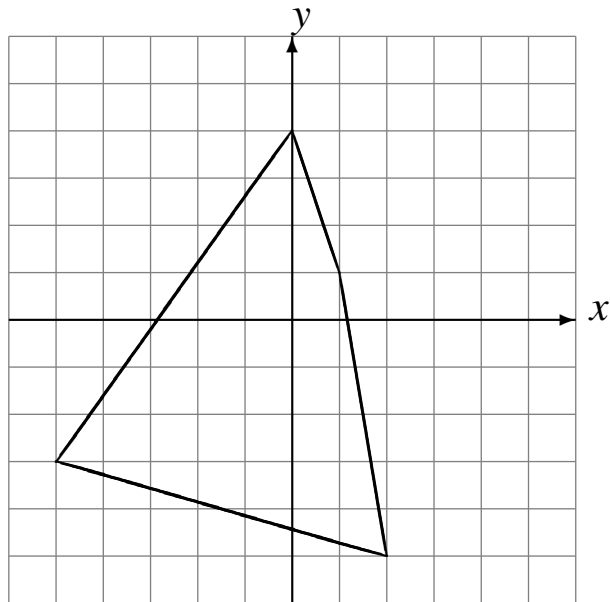

# Rotaciones (A) Respuestas

Dibuje cada figura rotada.

Rote  $-90^\circ$  alrededor de  $(0, 0)$ .

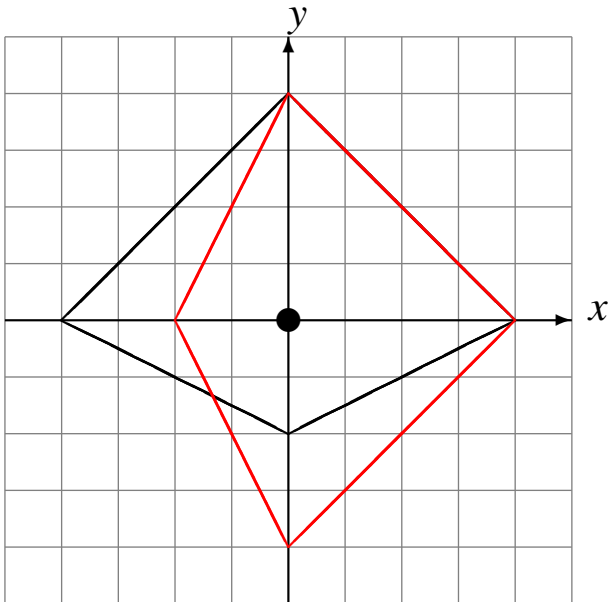

Rote  $90^\circ$  alrededor de  $(0, 0)$ .

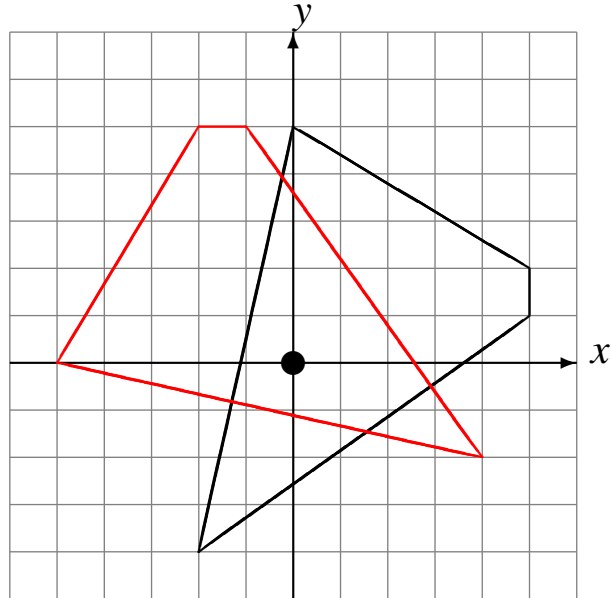

Rote  $90^\circ$  alrededor de  $(0, 0)$ .

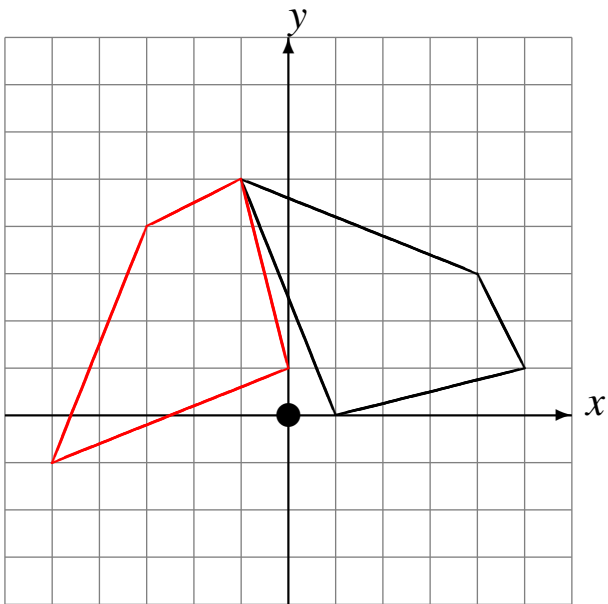

Rote  $180^\circ$  alrededor de  $(0, 0)$ .

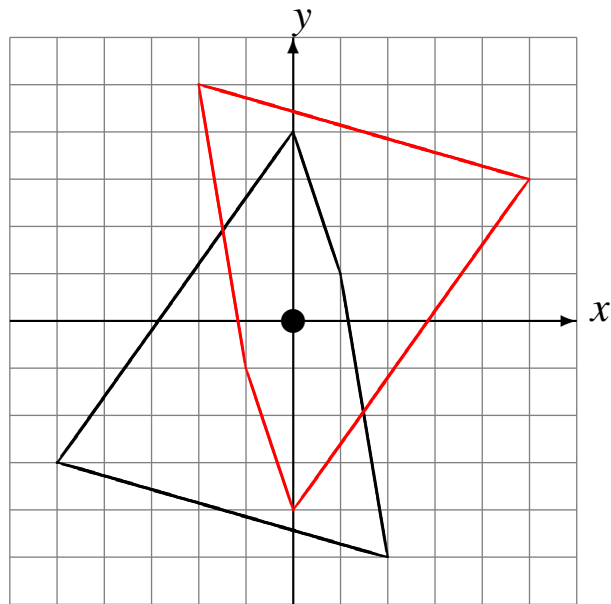

# Rotaciones (B)

Dibuje cada figura rotada.

Rote  $-90^\circ$  alrededor de  $(0, 0)$ .

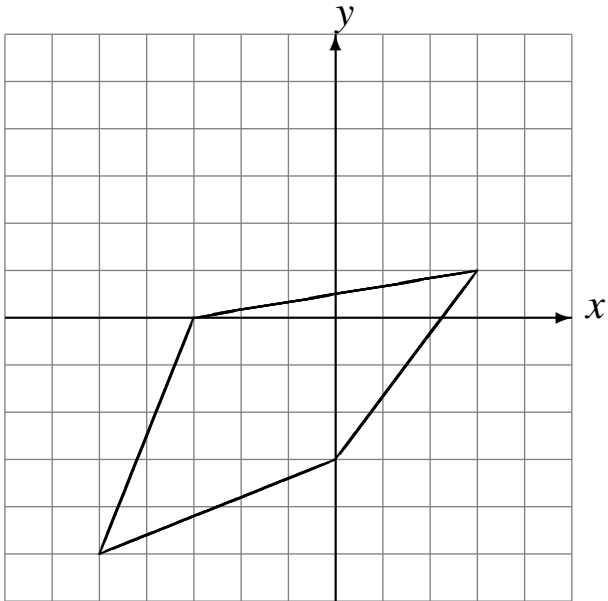

Rote  $180^\circ$  alrededor de  $(0, 0)$ .

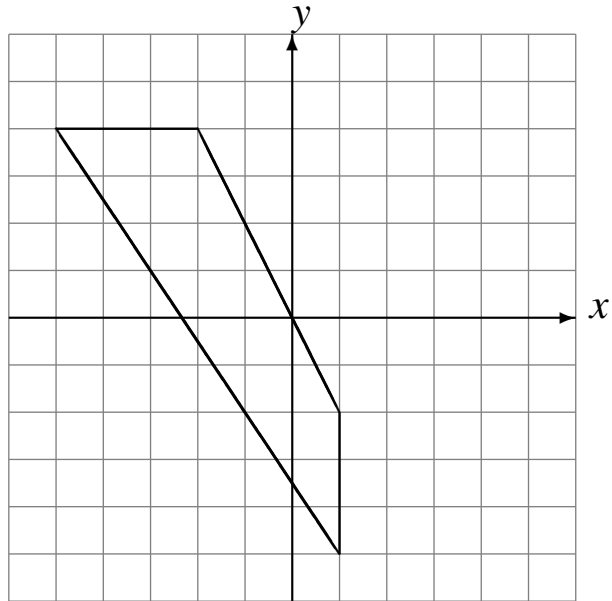

Rote  $180^\circ$  alrededor de  $(0, 0)$ .

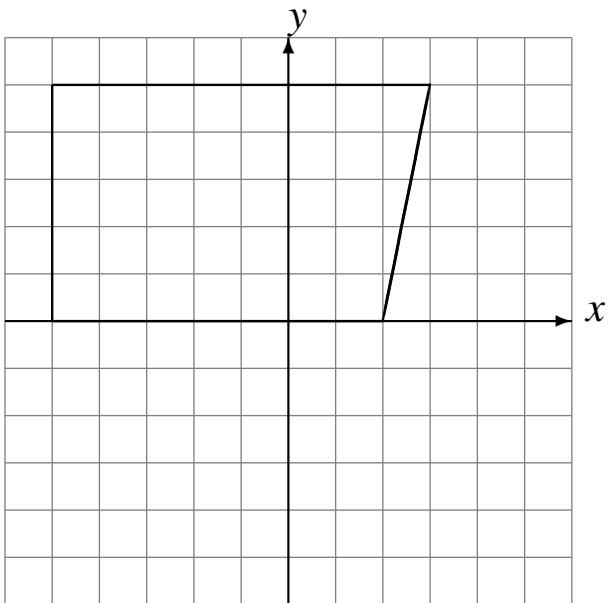

Rote  $180^\circ$  alrededor de  $(0, 0)$ .

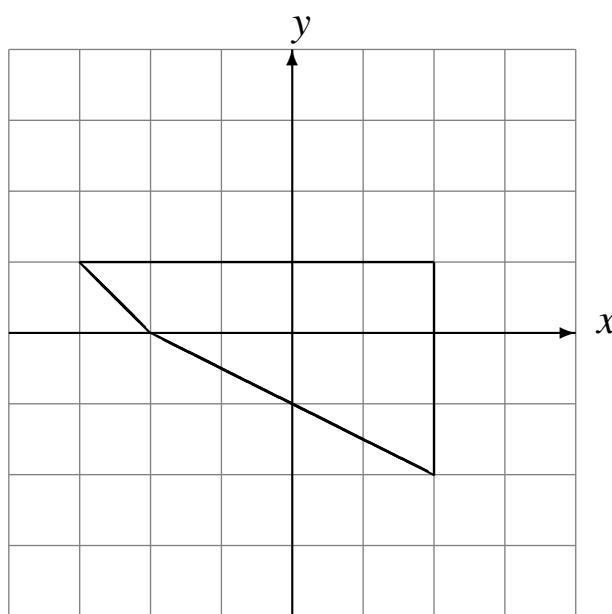

# Rotaciones (B) Respuestas

Dibuje cada figura rotada.

Rote  $-90^\circ$  alrededor de  $(0, 0)$ .

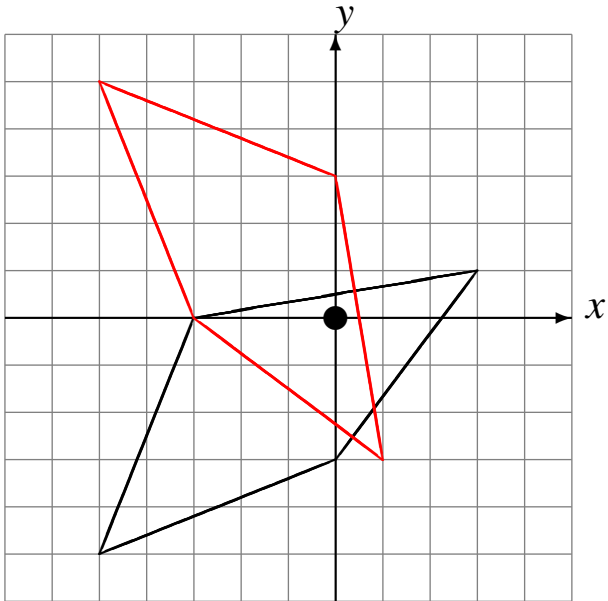

Rote  $180^\circ$  alrededor de  $(0, 0)$ .

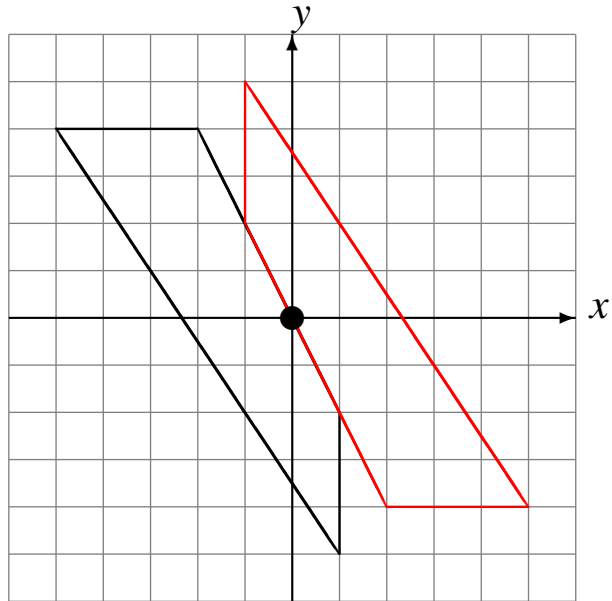

Rote  $180^\circ$  alrededor de  $(0, 0)$ .

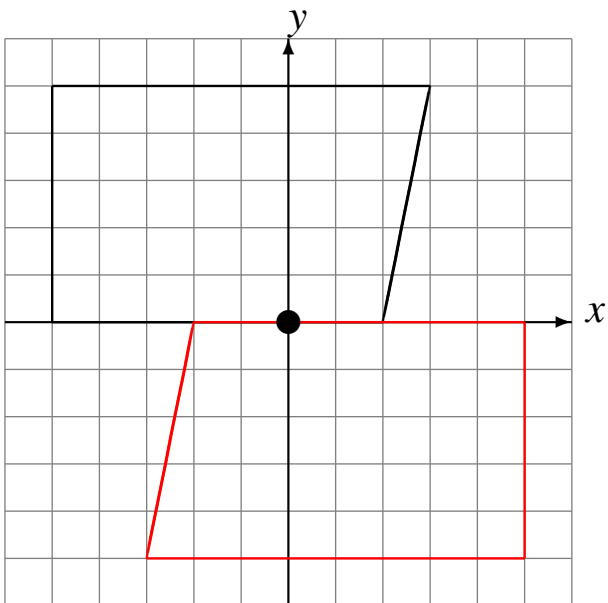

Rote  $180^\circ$  alrededor de  $(0, 0)$ .

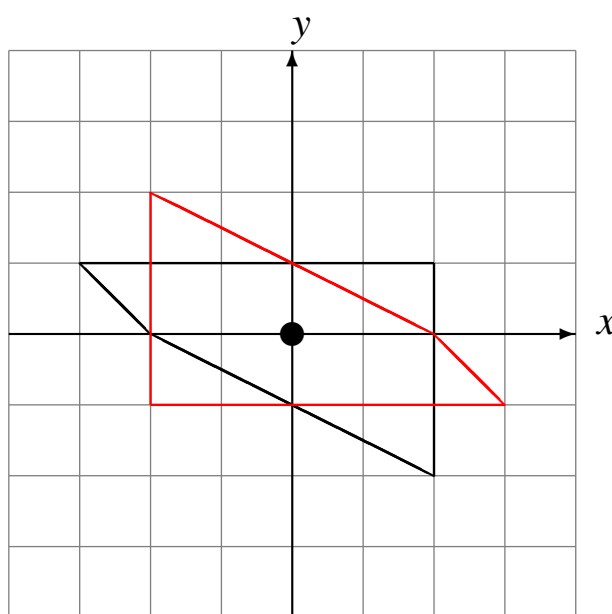

# Rotaciones (C)

Dibuje cada figura rotada.

Rote  $180^\circ$  alrededor de  $(0, 0)$ .

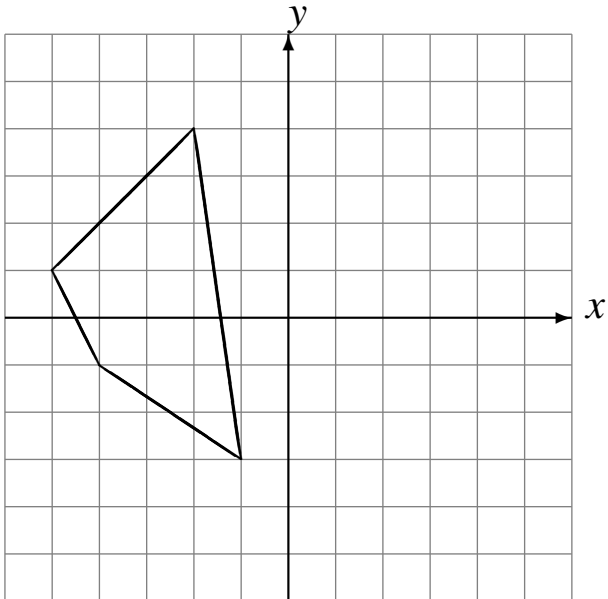

Rote  $180^\circ$  alrededor de  $(0, 0)$ .

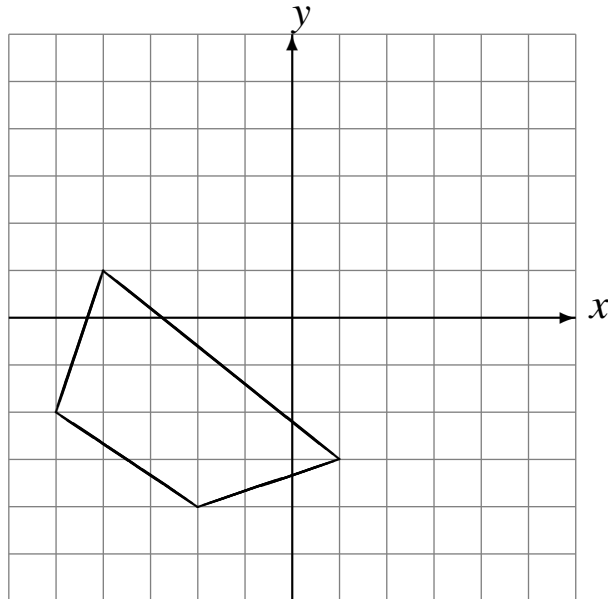

Rote  $-90^\circ$  alrededor de  $(0, 0)$ .

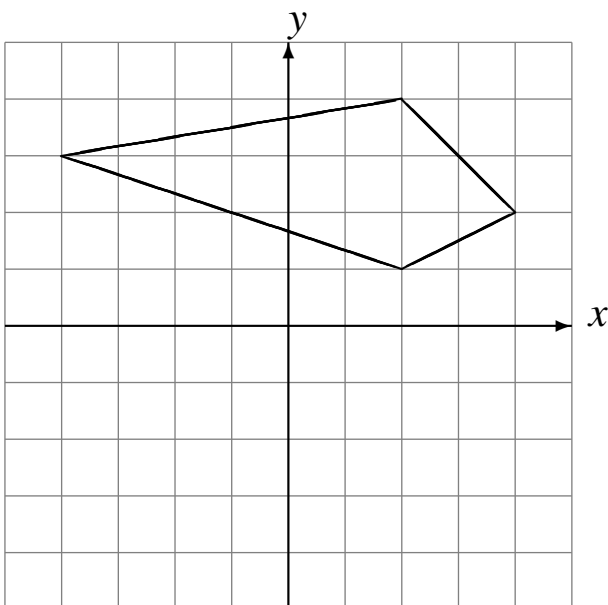

Rote  $180^\circ$  alrededor de  $(0, 0)$ .

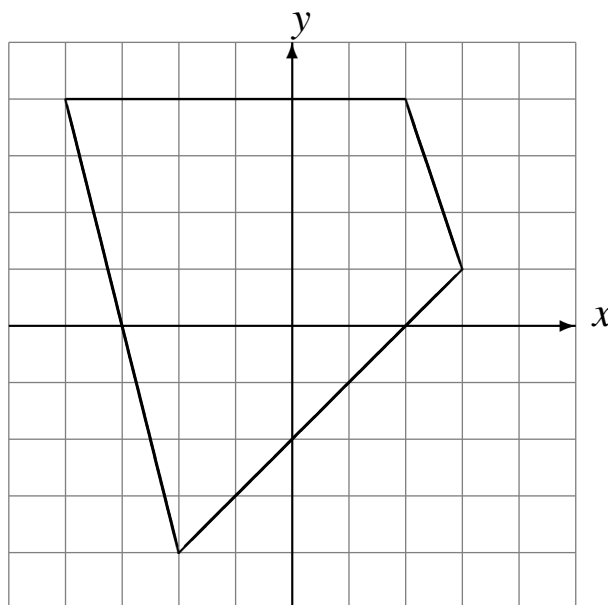

# Rotaciones (C) Respuestas

Dibuje cada figura rotada.

Rote  $180^\circ$  alrededor de  $(0, 0)$ .

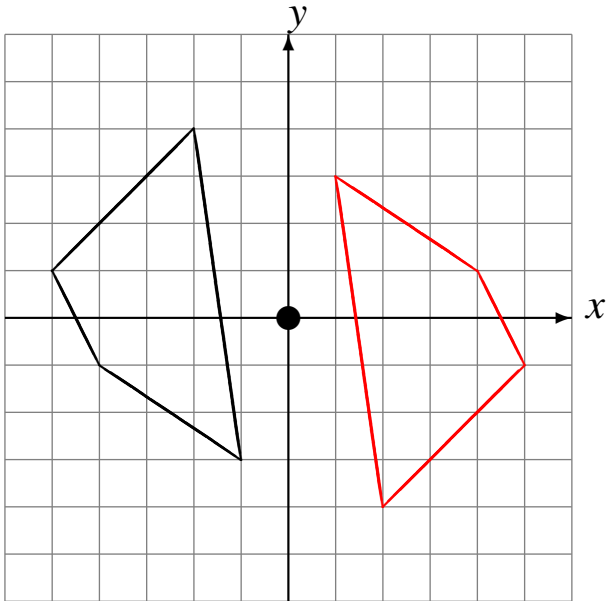

Rote  $180^\circ$  alrededor de  $(0, 0)$ .

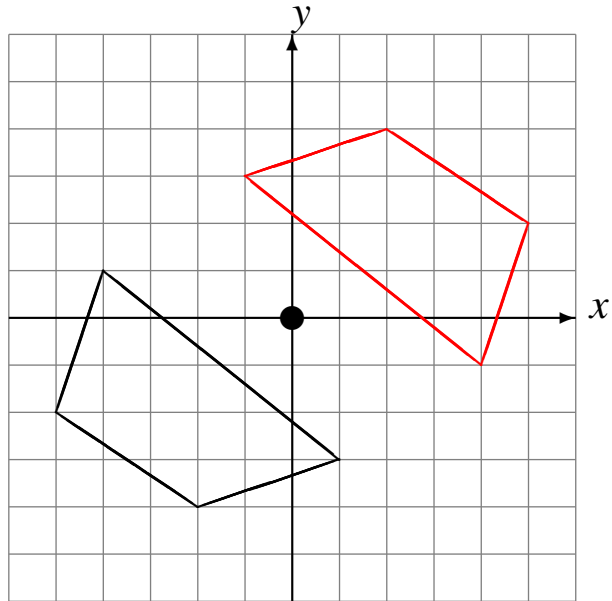

Rote  $-90^\circ$  alrededor de  $(0, 0)$ .

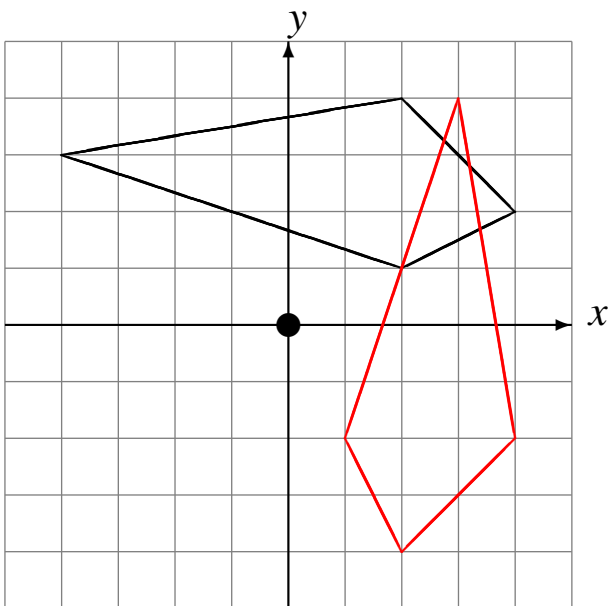

Rote  $180^\circ$  alrededor de  $(0, 0)$ .

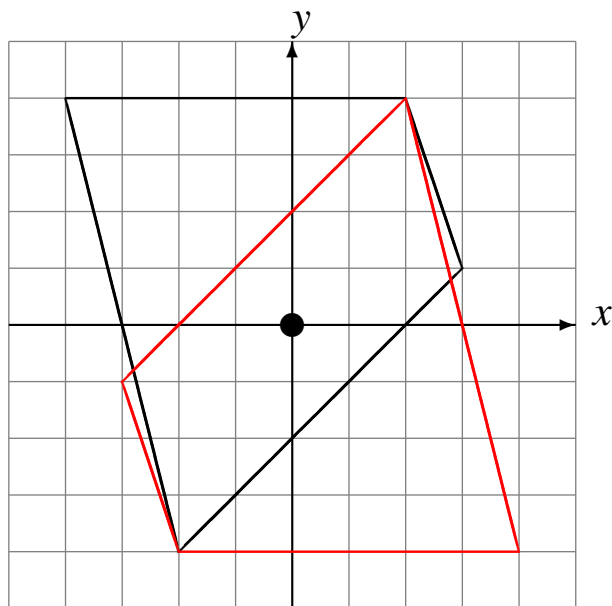

# Rotaciones (D)

Dibuje cada figura rotada.

Rote  $90^\circ$  alrededor de  $(0, 0)$ .

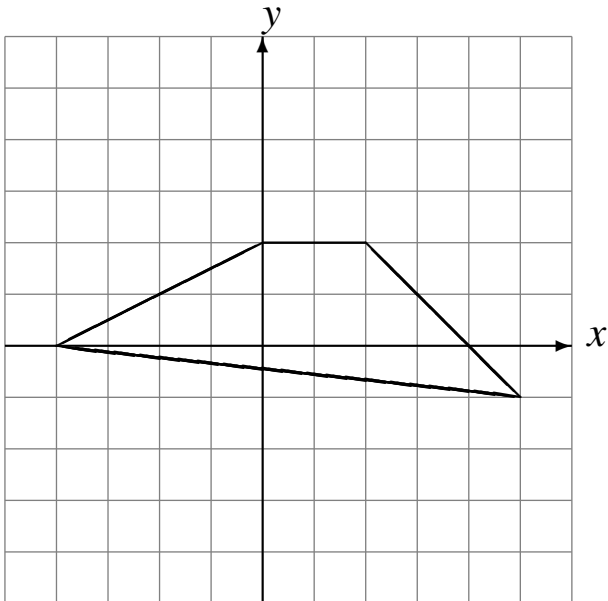

Rote  $180^\circ$  alrededor de  $(0, 0)$ .

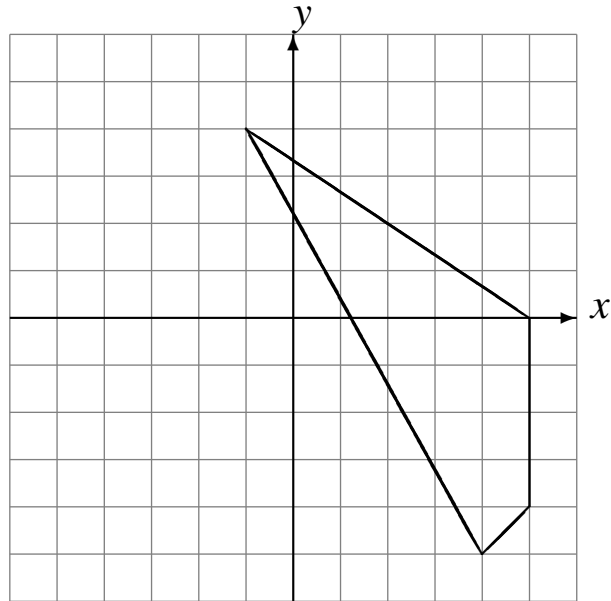

Rote  $180^\circ$  alrededor de  $(0, 0)$ .

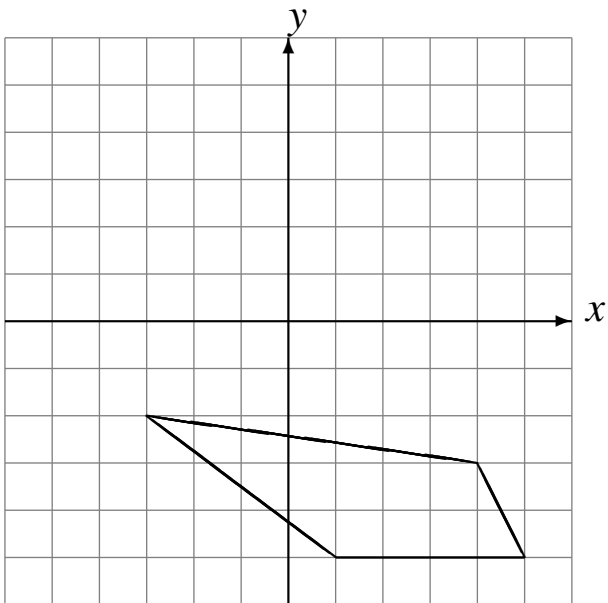

Rote  $-90^\circ$  alrededor de  $(0, 0)$ .

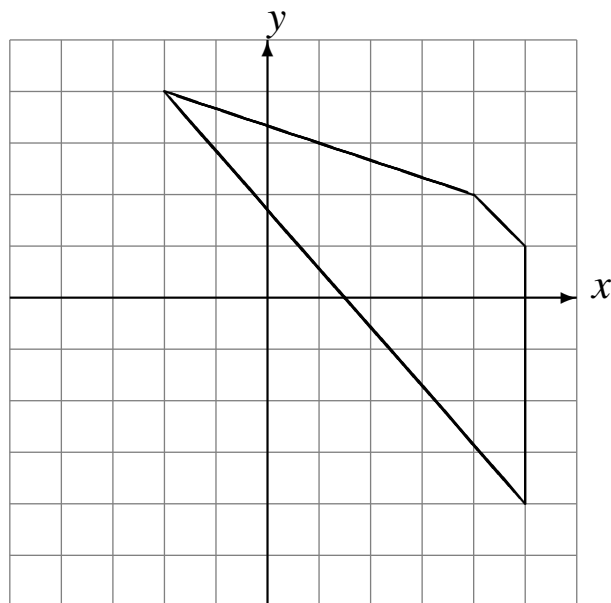

# Rotaciones (D) Respuestas

Dibuje cada figura rotada.

Rote  $90^\circ$  alrededor de  $(0, 0)$ .

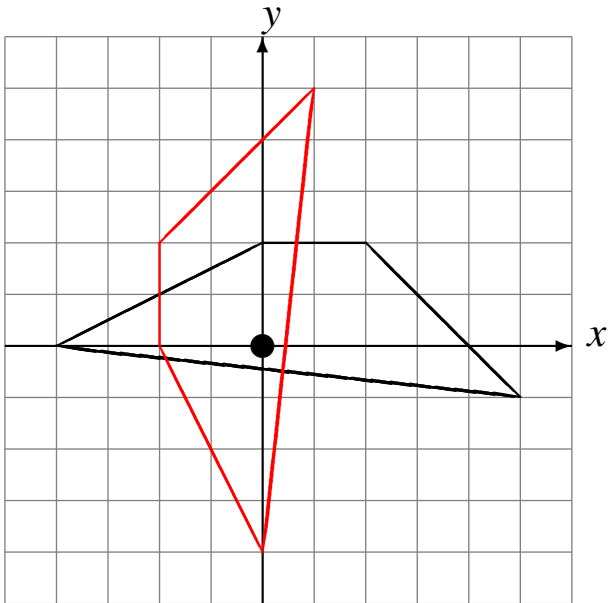

Rote  $180^\circ$  alrededor de  $(0, 0)$ .

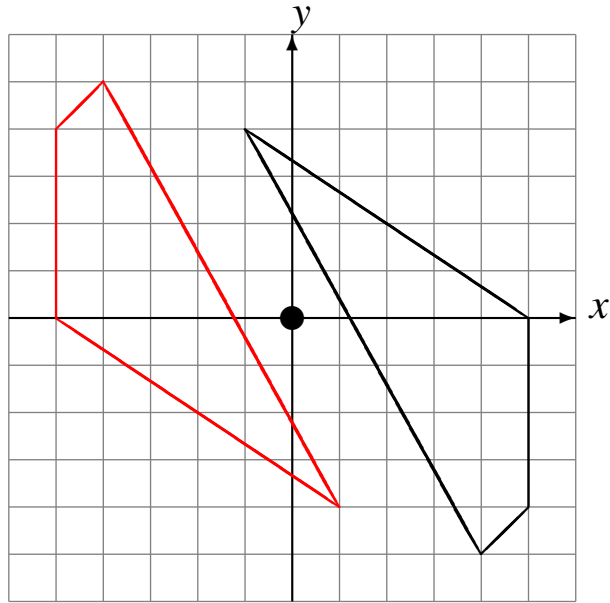

Rote  $180^\circ$  alrededor de  $(0, 0)$ .

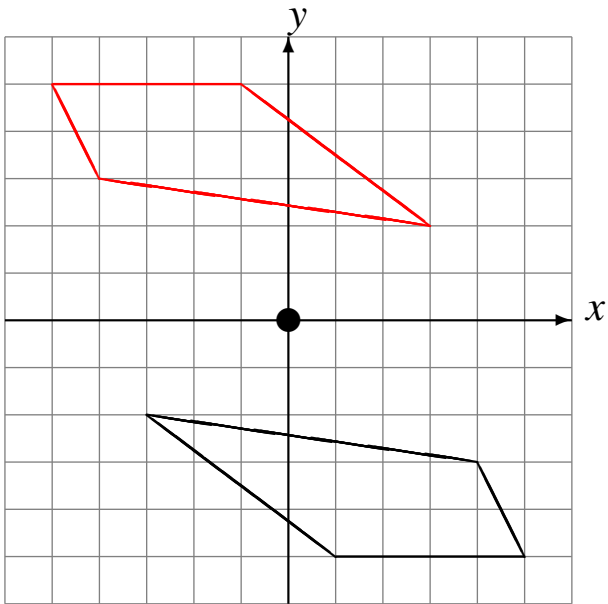

Rote  $-90^\circ$  alrededor de  $(0, 0)$ .

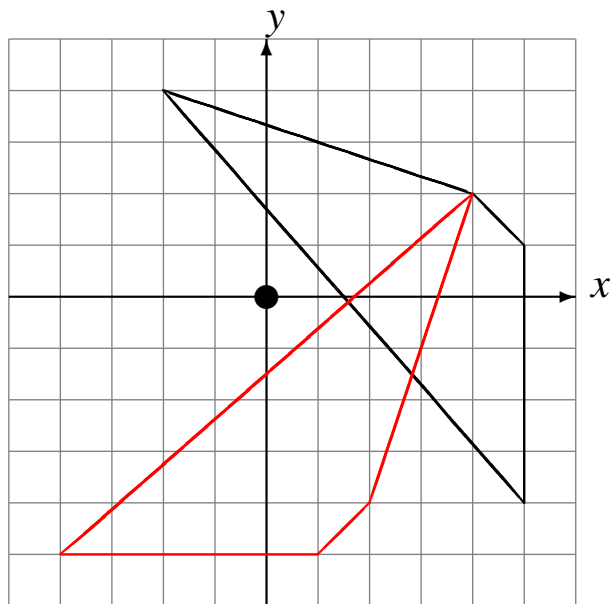



# Rotaciones (E)

Dibuje cada figura rotada.

Rote  $180^\circ$  alrededor de  $(0, 0)$ .

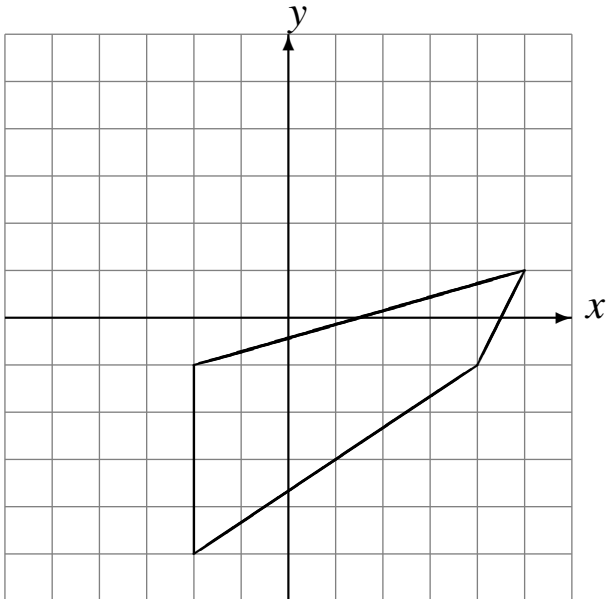

Rote  $90^\circ$  alrededor de  $(0, 0)$ .

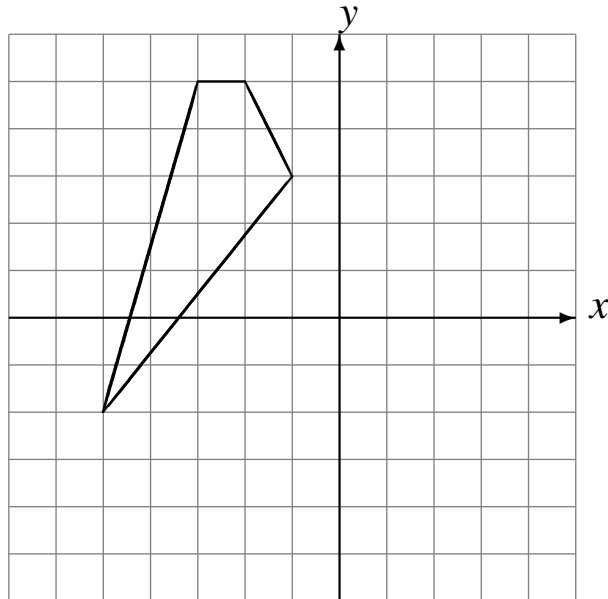

Rote  $-90^\circ$  alrededor de  $(0, 0)$ .

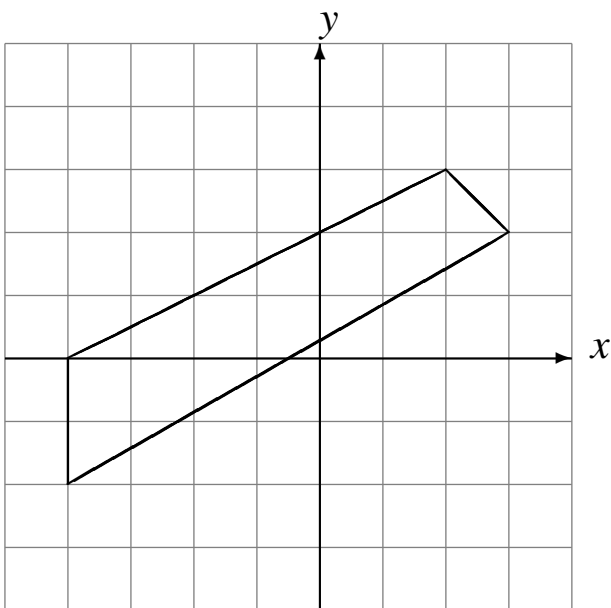

Rote  $90^\circ$  alrededor de  $(0, 0)$ .

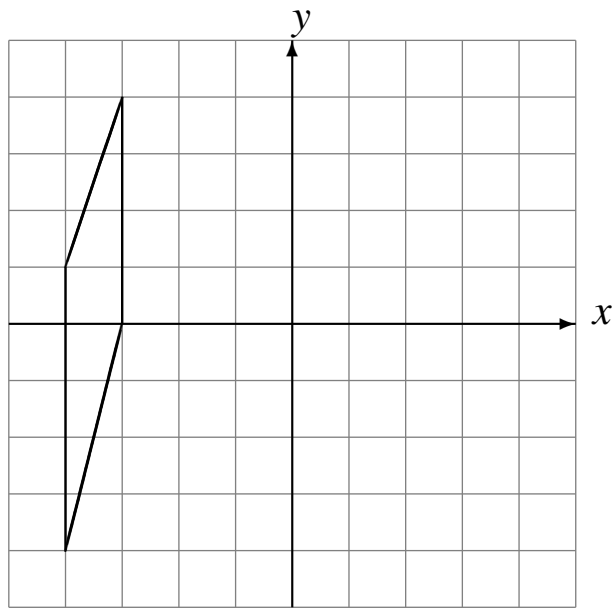

# Rotaciones (E) Respuestas

Dibuje cada figura rotada.

Rote  $180^\circ$  alrededor de  $(0, 0)$ .

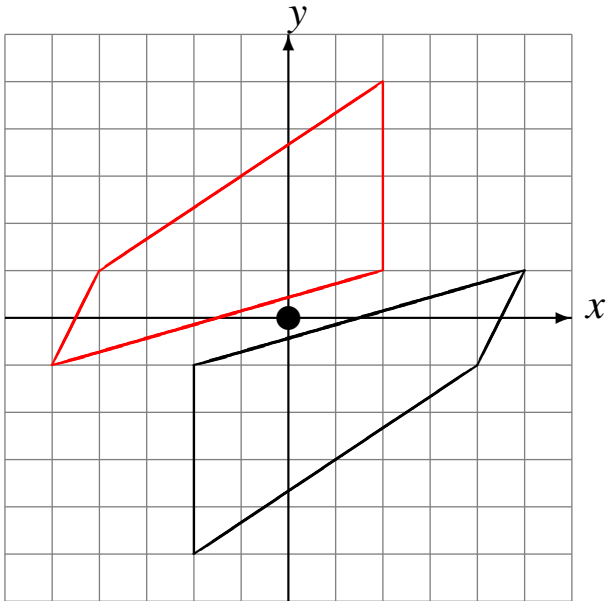

Rote  $90^\circ$  alrededor de  $(0, 0)$ .

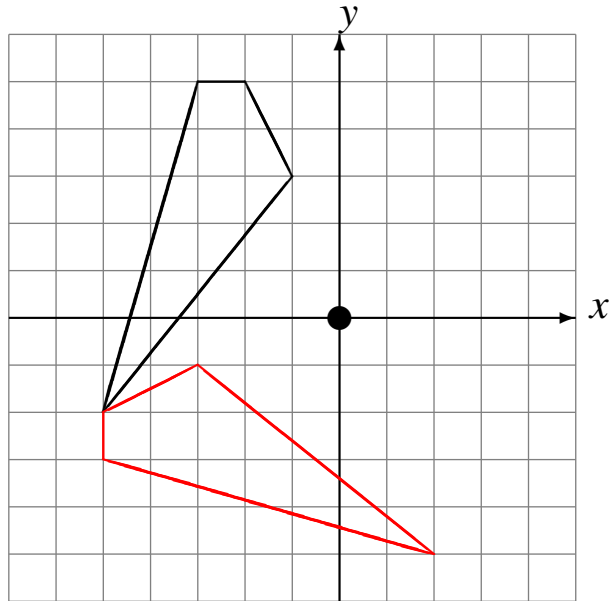

Rote  $-90^\circ$  alrededor de  $(0, 0)$ .

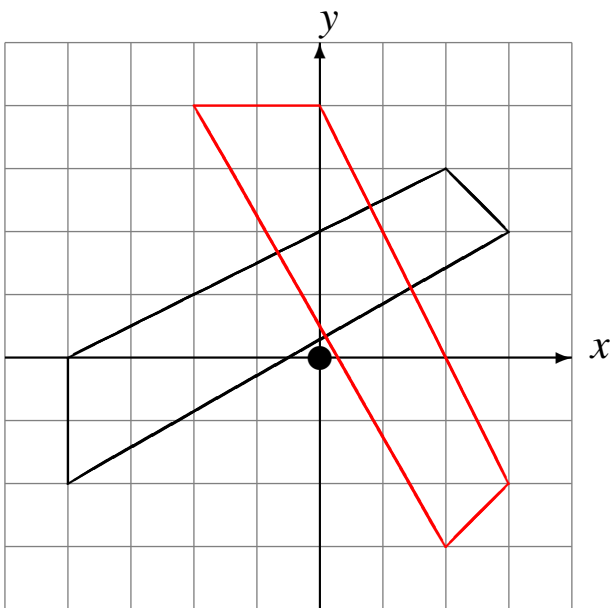

Rote  $90^\circ$  alrededor de  $(0, 0)$ .

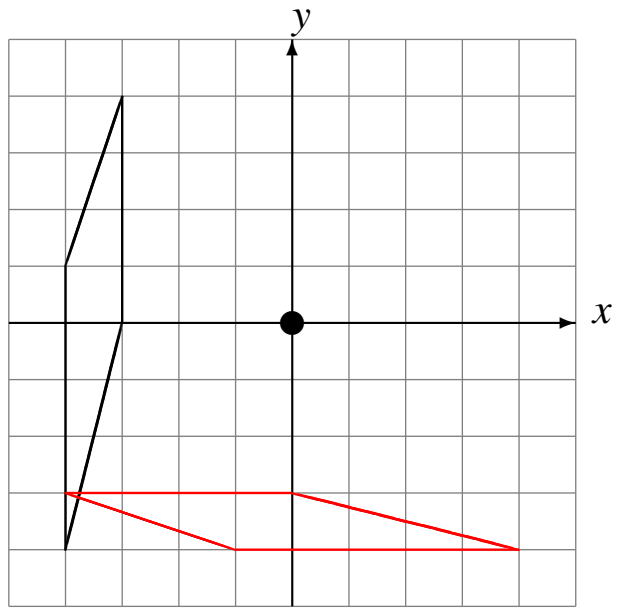

# Rotaciones (F)

Dibuje cada figura rotada.

Rote  $180^\circ$  alrededor de  $(0, 0)$ .

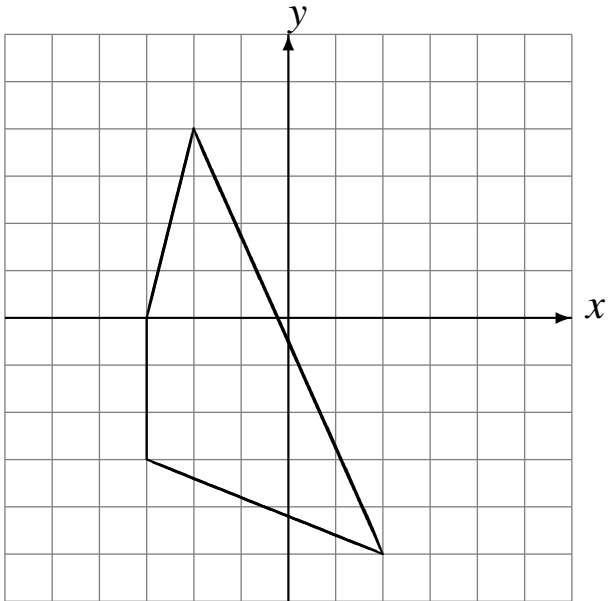

Rote  $90^\circ$  alrededor de  $(0, 0)$ .

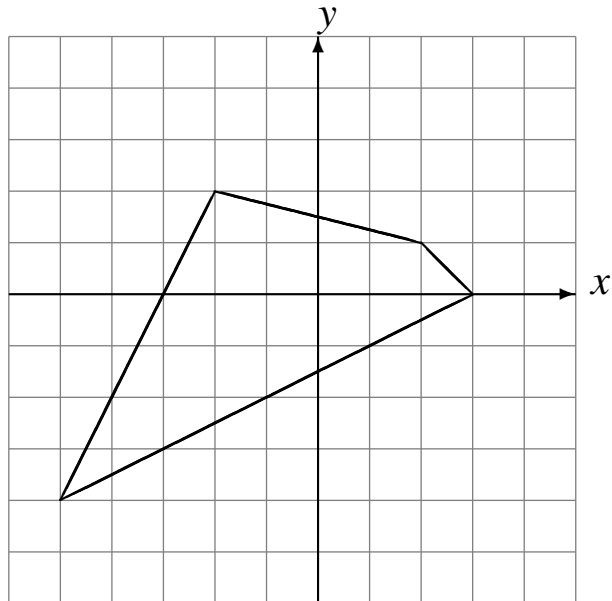

Rote  $-90^\circ$  alrededor de  $(0, 0)$ .

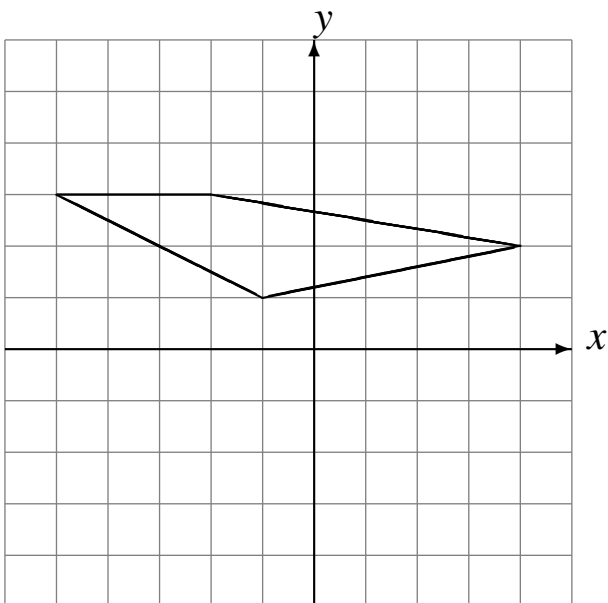

Rote  $-90^\circ$  alrededor de  $(0, 0)$ .

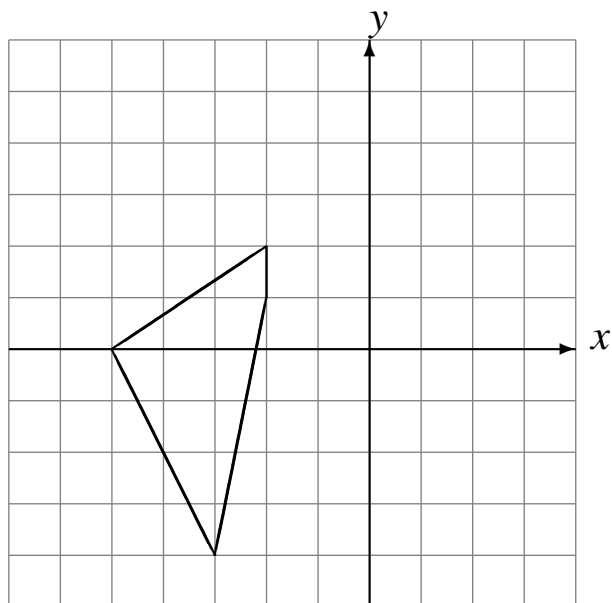

# Rotaciones (F) Respuestas

Dibuje cada figura rotada.

Rote  $180^\circ$  alrededor de  $(0, 0)$ .

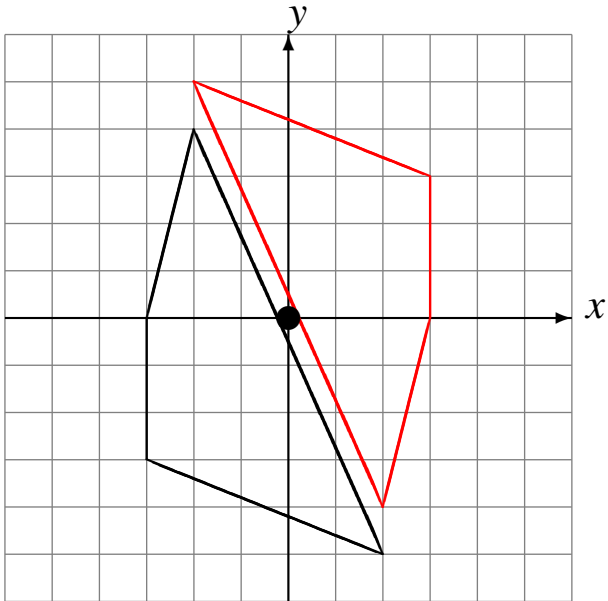

Rote  $90^\circ$  alrededor de  $(0, 0)$ .

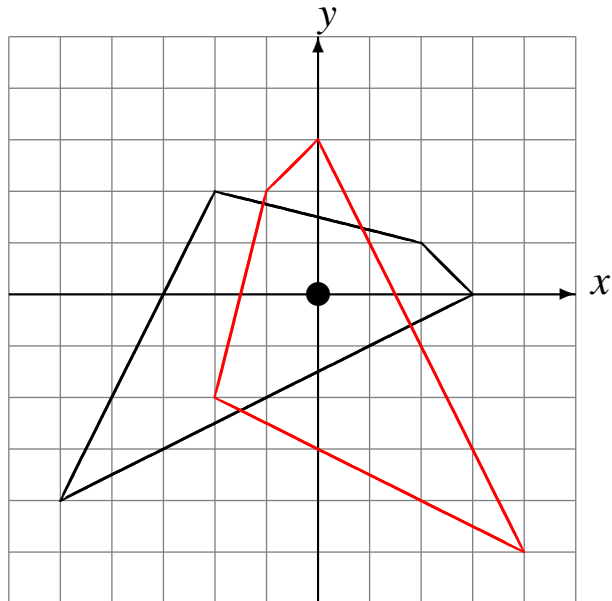

Rote  $-90^\circ$  alrededor de  $(0, 0)$ .

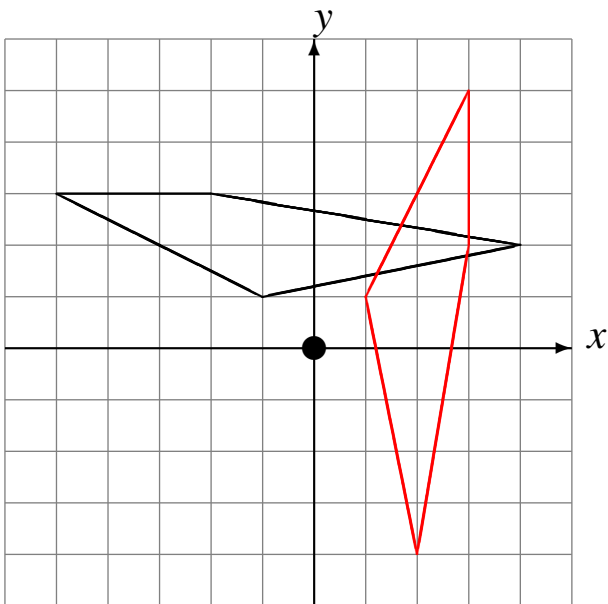

Rote  $-90^\circ$  alrededor de  $(0, 0)$ .

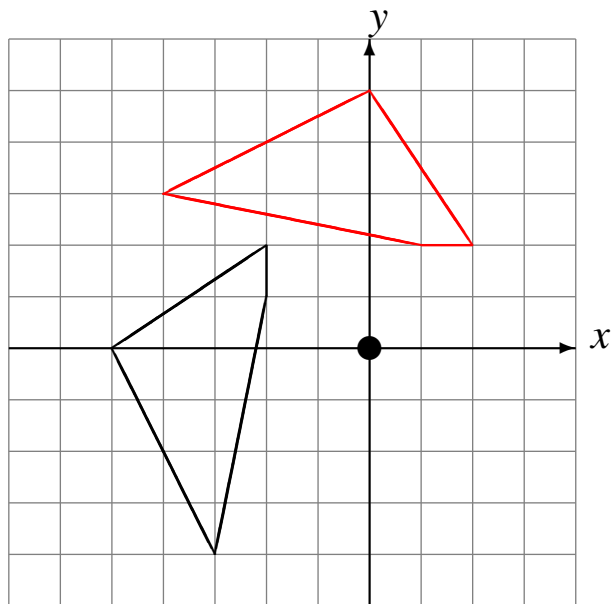

# Rotaciones (G)

Dibuje cada figura rotada.

Rote  $-90^\circ$  alrededor de  $(0, 0)$ .

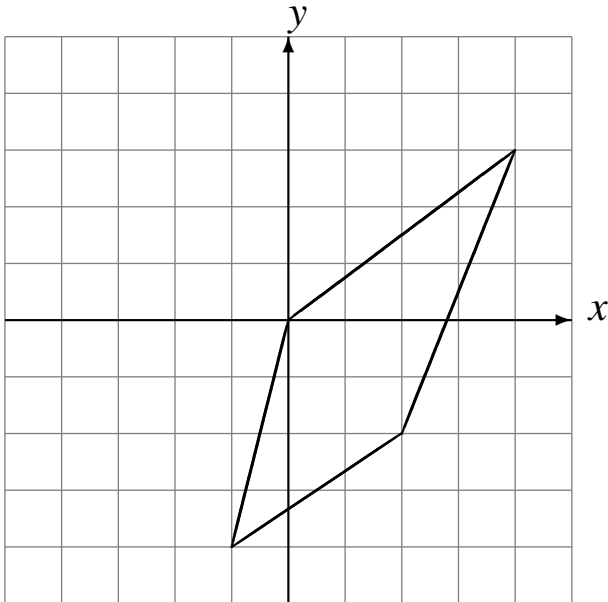

Rote  $90^\circ$  alrededor de  $(0, 0)$ .

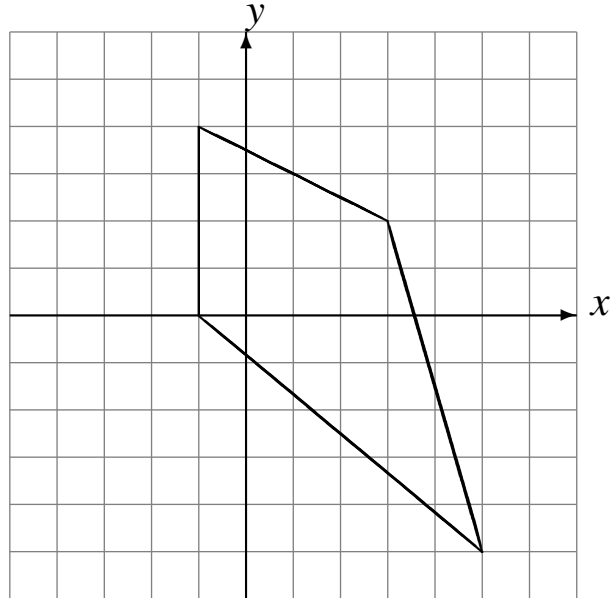

Rote  $-90^\circ$  alrededor de  $(0, 0)$ .

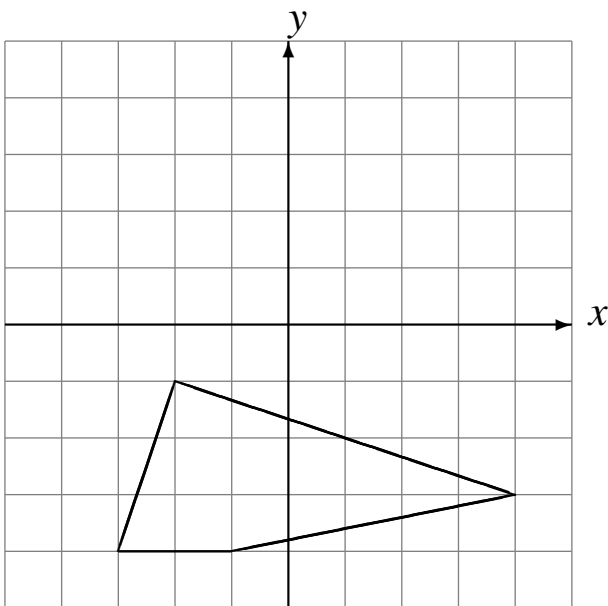

Rote  $-90^\circ$  alrededor de  $(0, 0)$ .

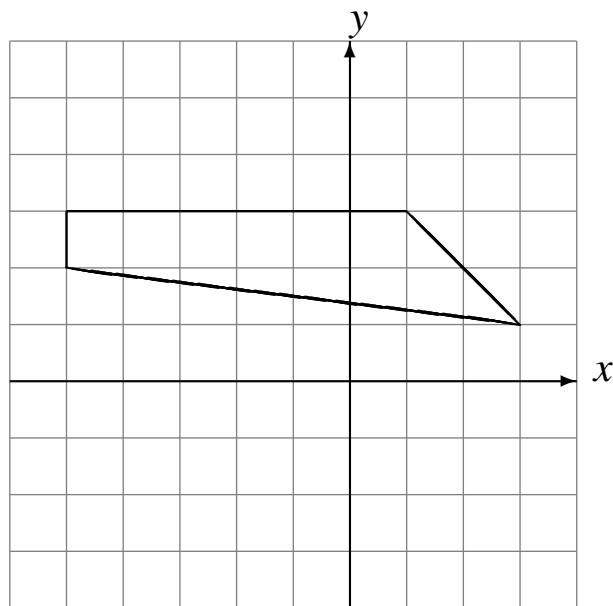

# Rotaciones (G) Respuestas

Dibuje cada figura rotada.

Rote  $-90^\circ$  alrededor de  $(0, 0)$ .

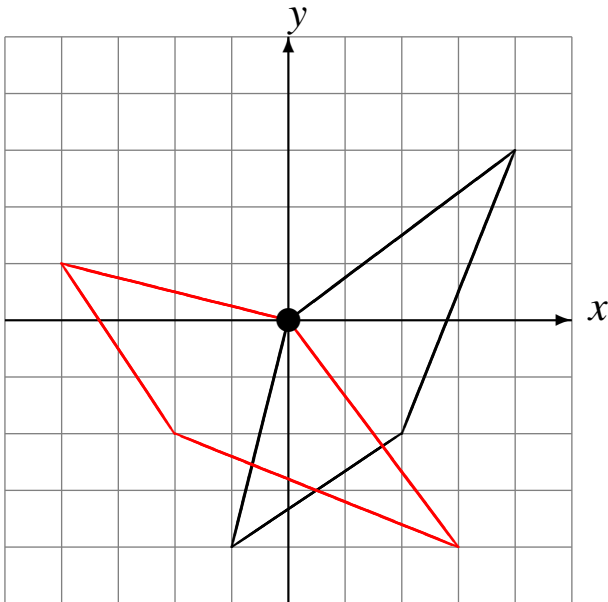

Rote  $90^\circ$  alrededor de  $(0, 0)$ .

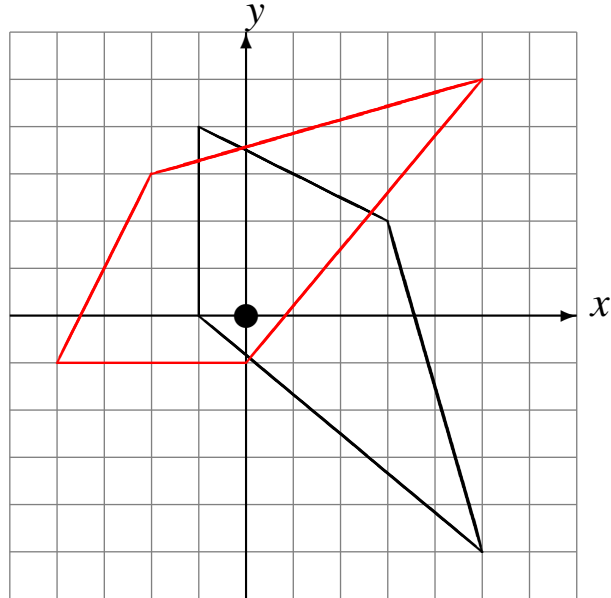

Rote  $-90^\circ$  alrededor de  $(0, 0)$ .

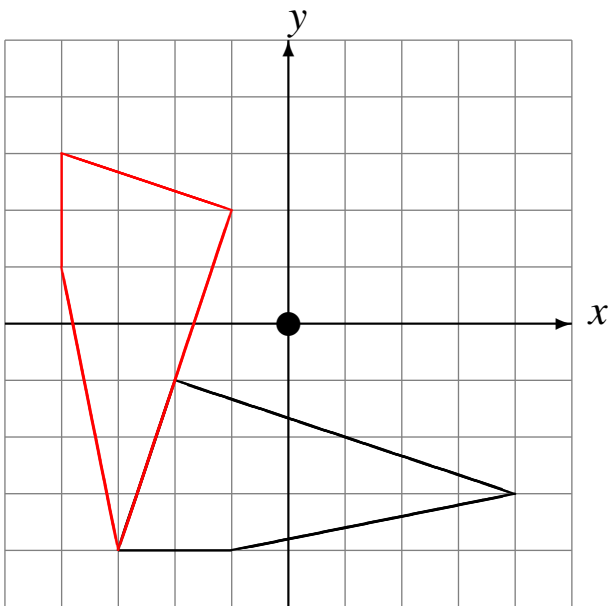

Rote  $-90^\circ$  alrededor de  $(0, 0)$ .

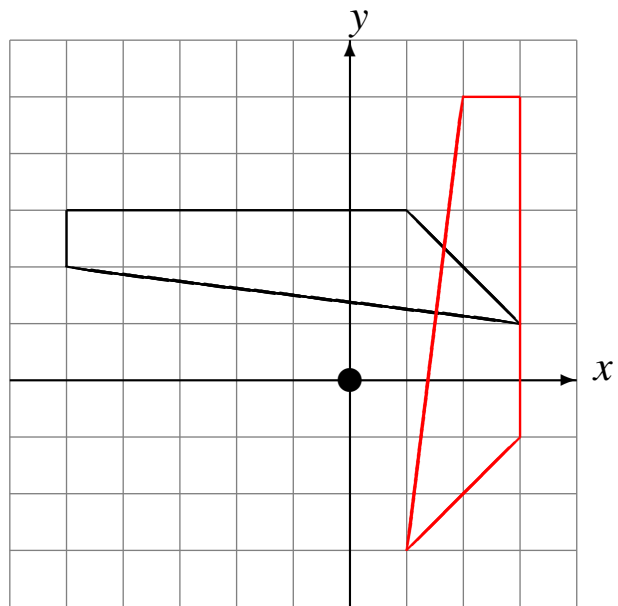

# Rotaciones (H)

Dibuje cada figura rotada.

Rote  $180^\circ$  alrededor de  $(0, 0)$ .

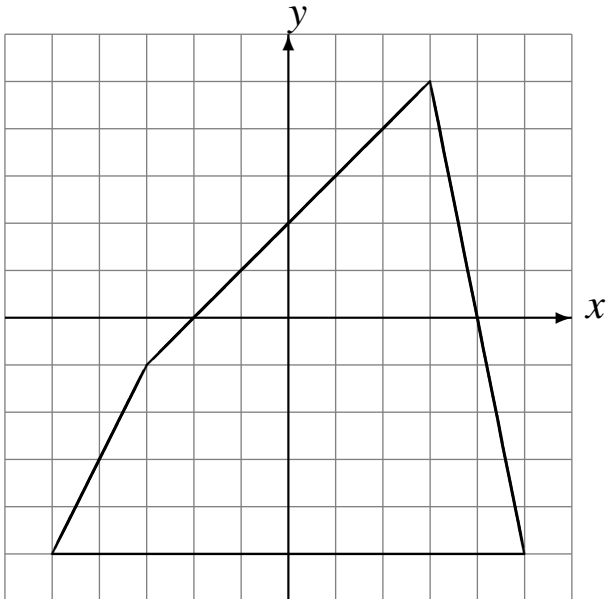

Rote  $180^\circ$  alrededor de  $(0, 0)$ .

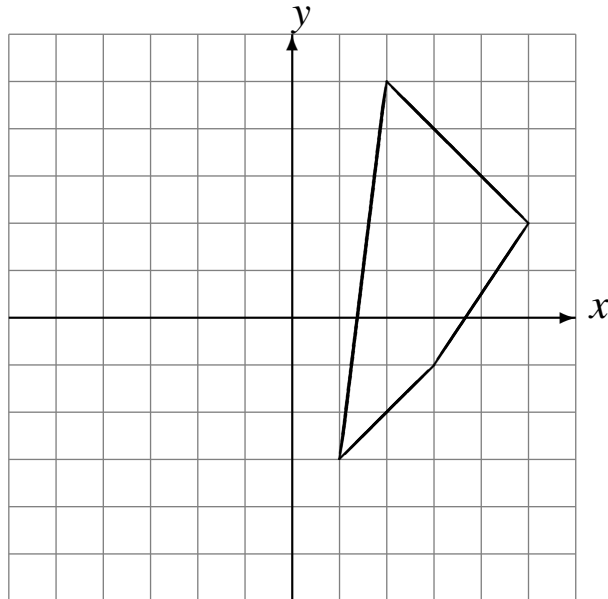

Rote  $180^\circ$  alrededor de  $(0, 0)$ .

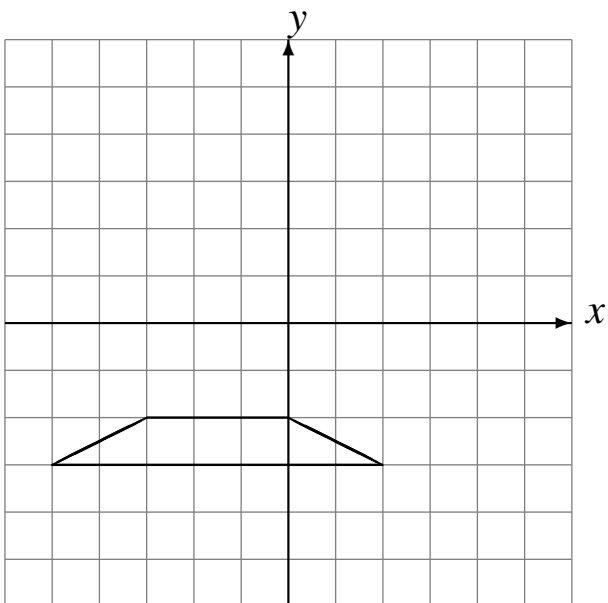

Rote  $90^\circ$  alrededor de  $(0, 0)$ .

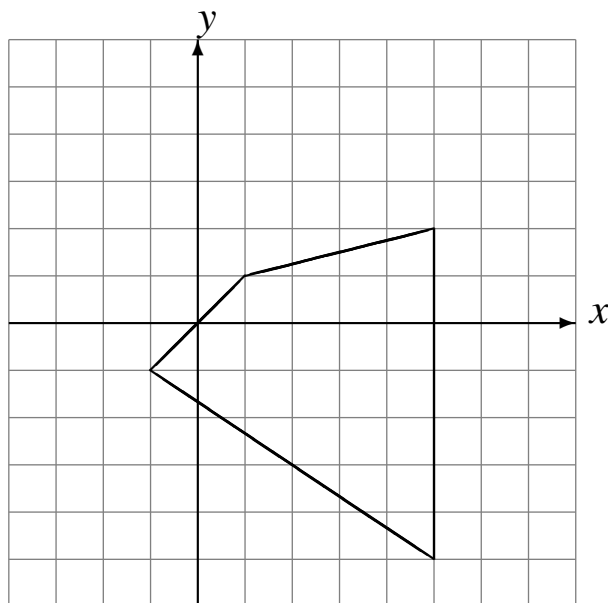

# Rotaciones (H) Respuestas

Dibuje cada figura rotada.

Rote  $180^\circ$  alrededor de  $(0, 0)$ .

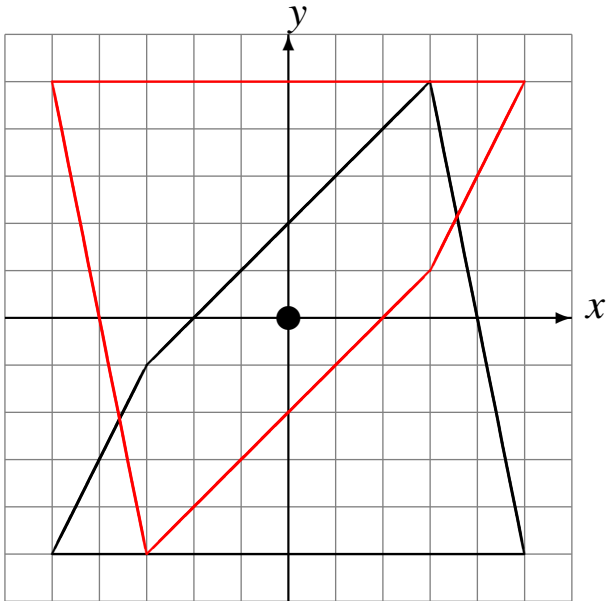

Rote  $180^\circ$  alrededor de  $(0, 0)$ .

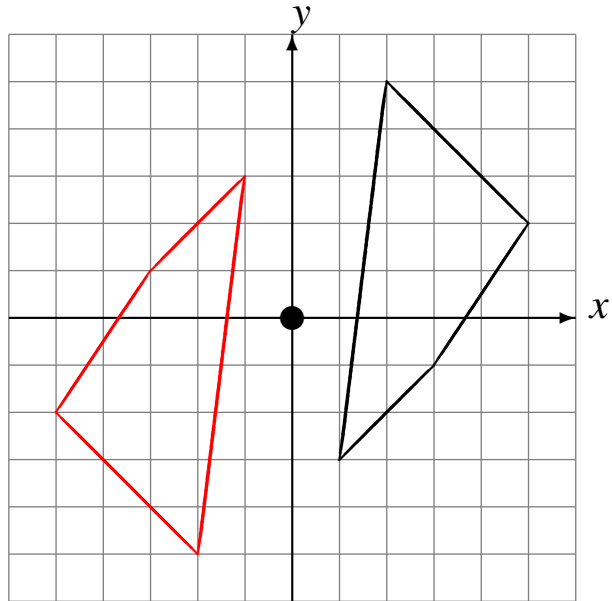

Rote  $180^\circ$  alrededor de  $(0, 0)$ .

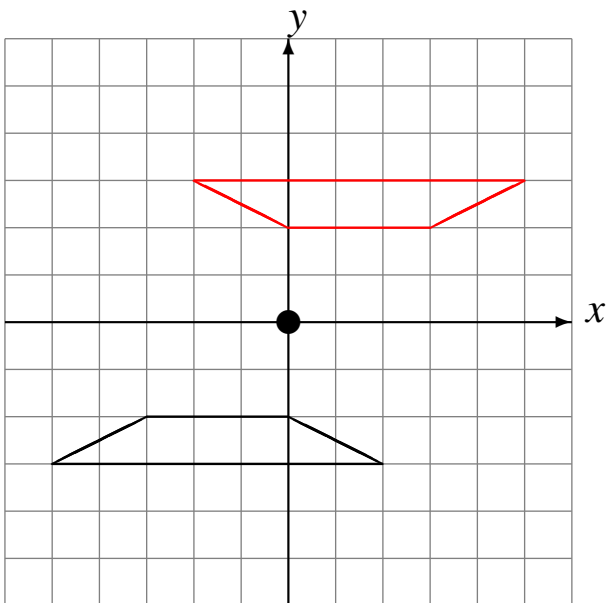

Rote  $90^\circ$  alrededor de  $(0, 0)$ .

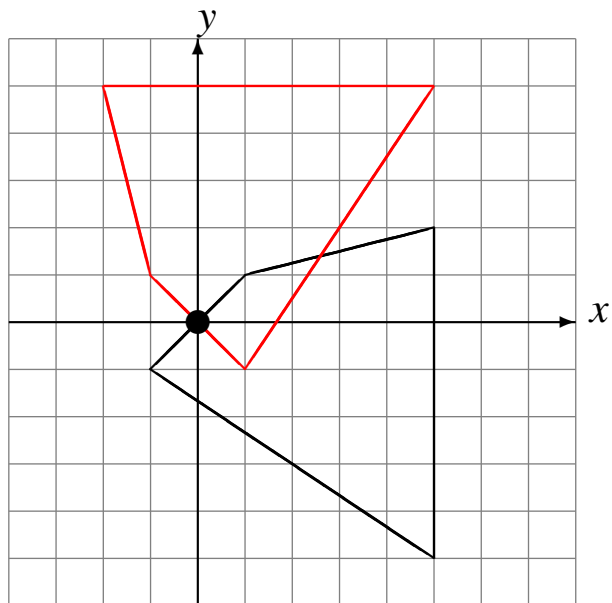



# Rotaciones (I)

Dibuje cada figura rotada.

Rote  $180^\circ$  alrededor de  $(0, 0)$ .

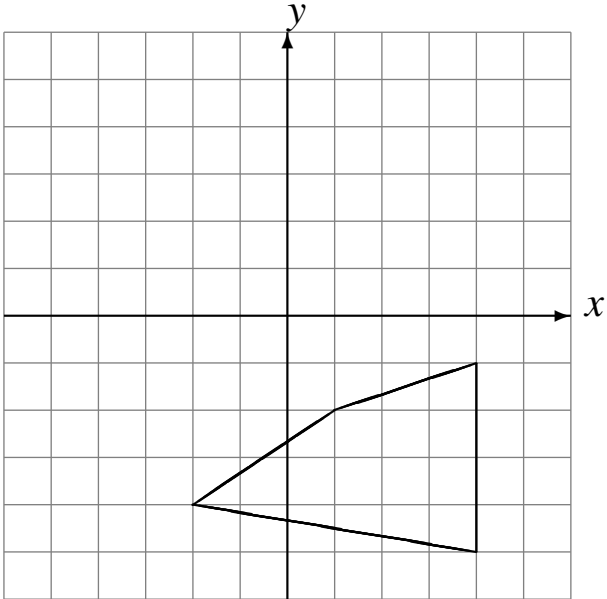

Rote  $90^\circ$  alrededor de  $(0, 0)$ .

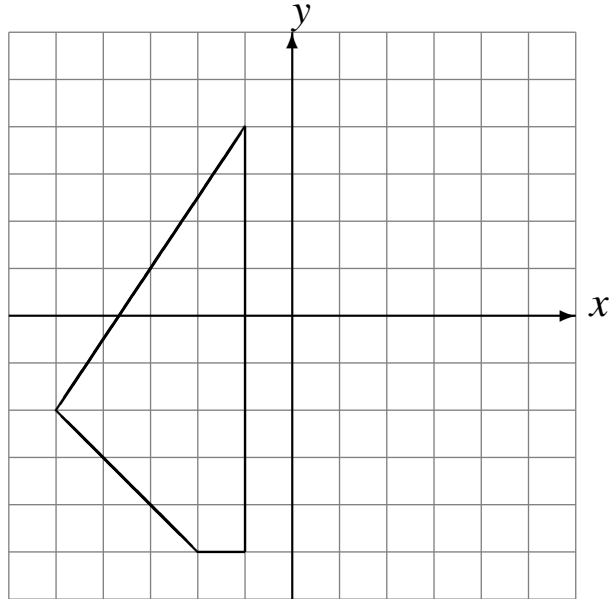

Rote  $90^\circ$  alrededor de  $(0, 0)$ .

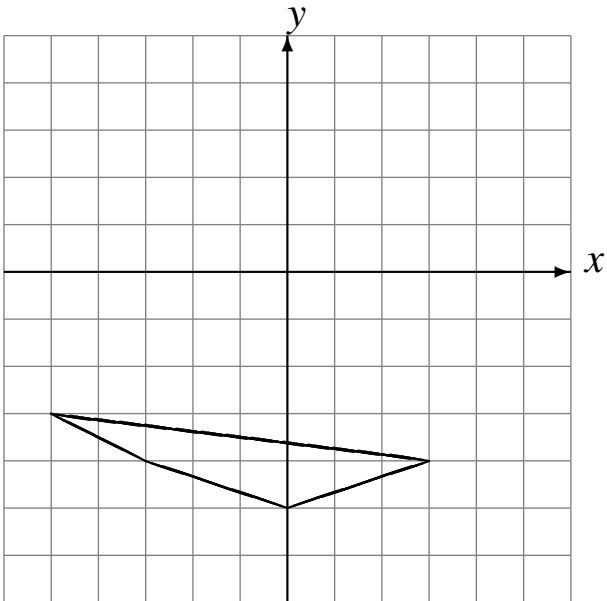

Rote  $90^\circ$  alrededor de  $(0, 0)$ .

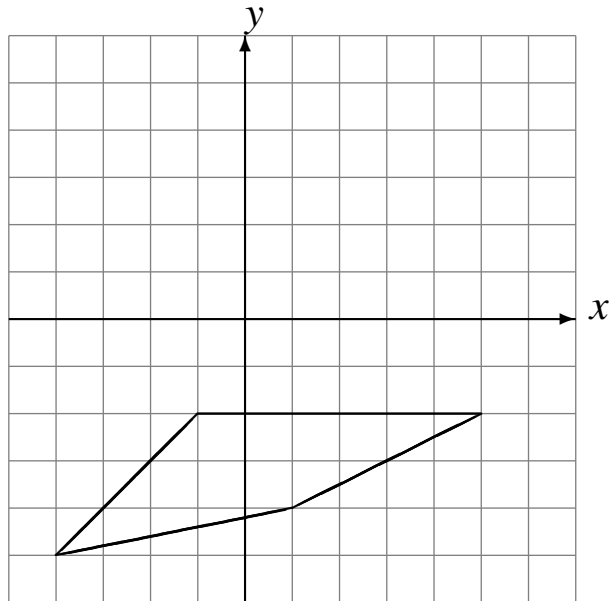

# Rotaciones (I) Respuestas

Dibuje cada figura rotada.

Rote  $180^\circ$  alrededor de  $(0, 0)$ .

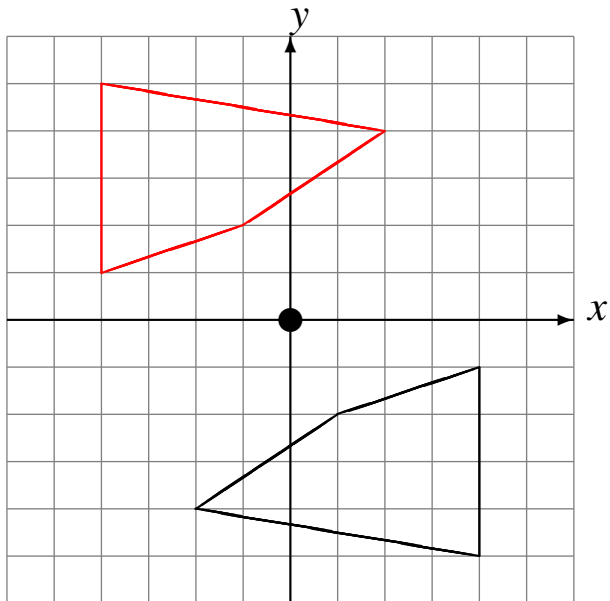

Rote  $90^\circ$  alrededor de  $(0, 0)$ .

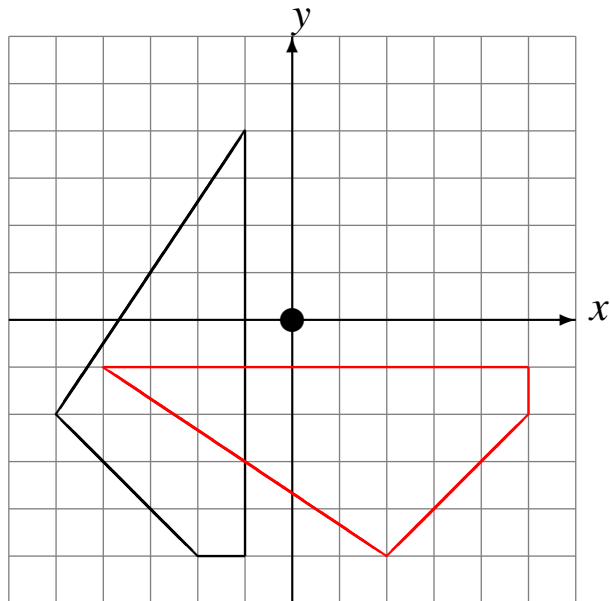

Rote  $90^\circ$  alrededor de  $(0, 0)$ .

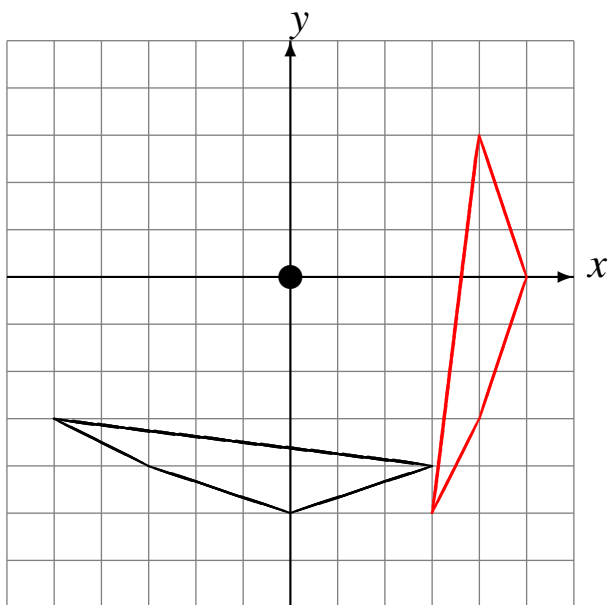

Rote  $90^\circ$  alrededor de  $(0, 0)$ .

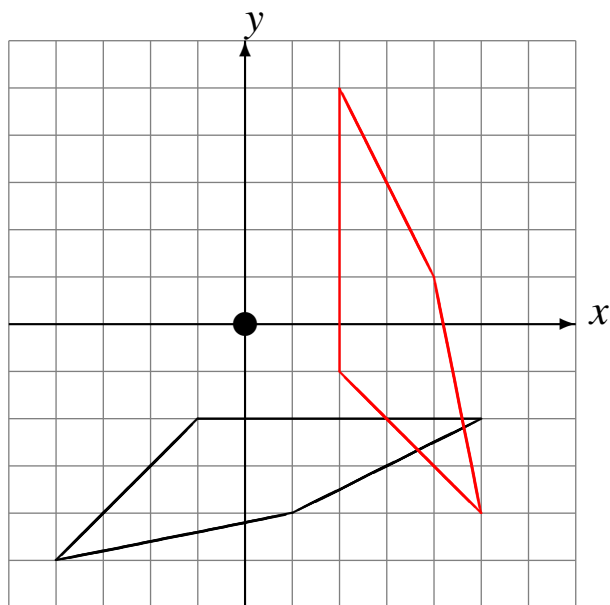

# Rotaciones (J)

Dibuje cada figura rotada.

Rote  $180^\circ$  alrededor de  $(0, 0)$ .

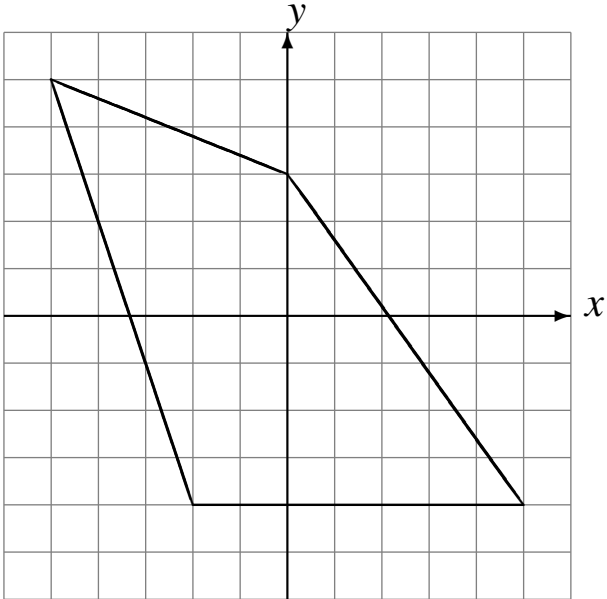

Rote  $-90^\circ$  alrededor de  $(0, 0)$ .

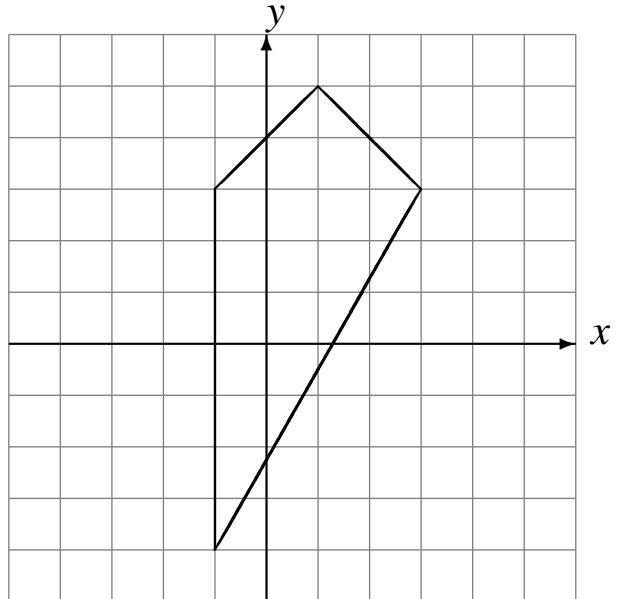

Rote  $180^\circ$  alrededor de  $(0, 0)$ .

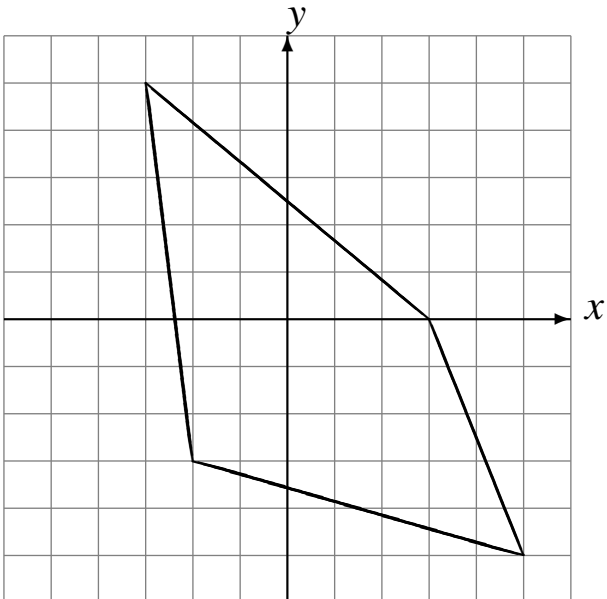

Rote  $180^\circ$  alrededor de  $(0, 0)$ .

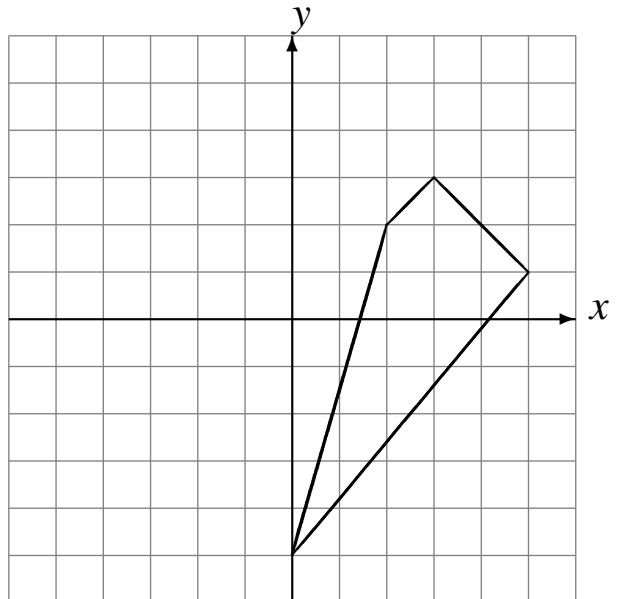

# Rotaciones (J) Respuestas

Dibuje cada figura rotada.

Rote  $180^\circ$  alrededor de  $(0, 0)$ .

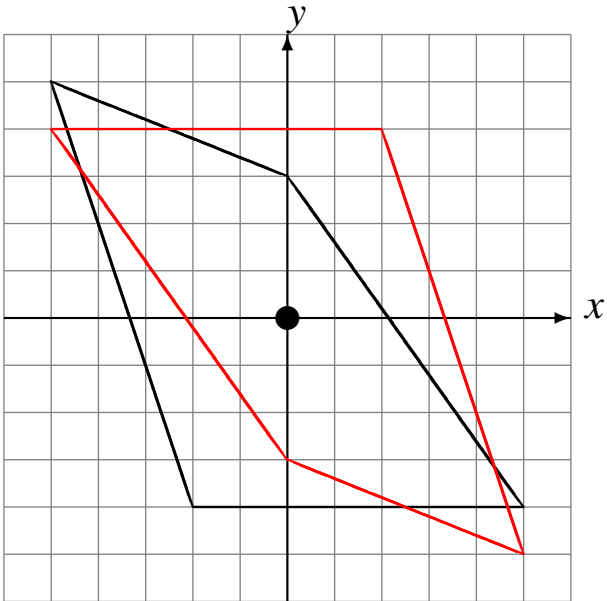

Rote  $-90^\circ$  alrededor de  $(0, 0)$ .

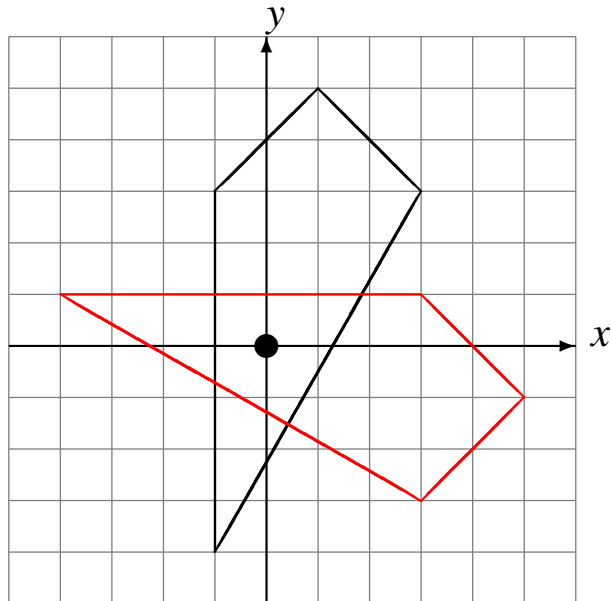

Rote  $180^\circ$  alrededor de  $(0, 0)$ .

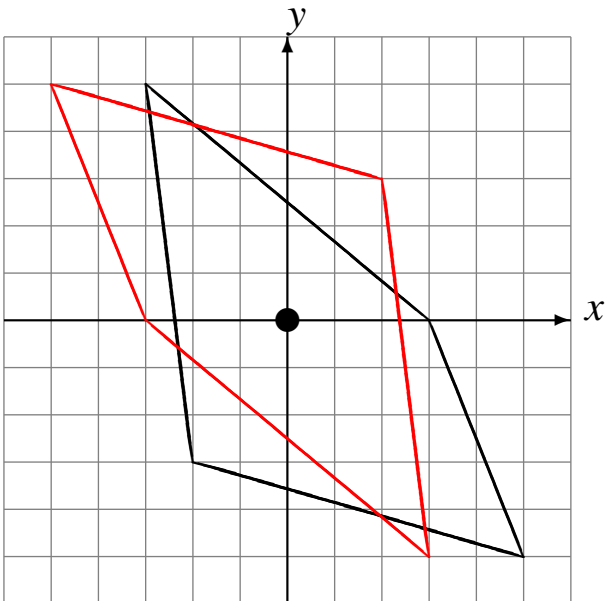

Rote  $180^\circ$  alrededor de  $(0, 0)$ .

