

Traslaciones (A)

Dibuje cada figura trasladada.

Traslade $(-6, -3)$.
Traslade $(-1, 0)$.
Traslade $(4, -5)$.

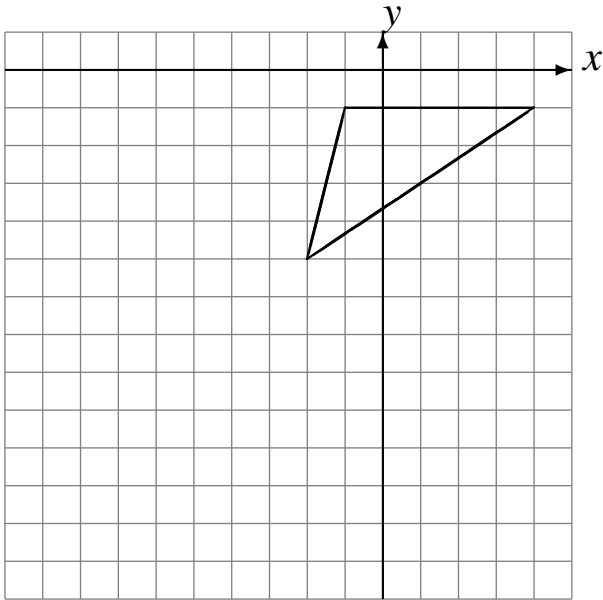

Traslade $(0, 3)$.
Traslade $(5, -5)$.
Traslade $(4, -5)$.

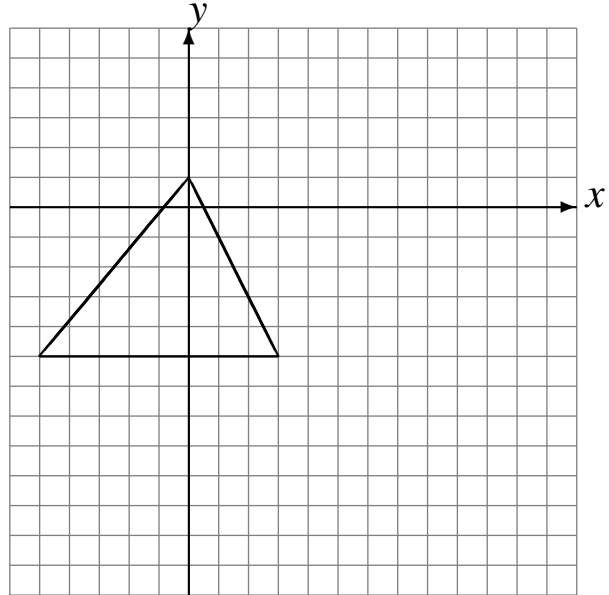

Traslade $(-6, 5)$.
Traslade $(1, 1)$.
Traslade $(3, 0)$.

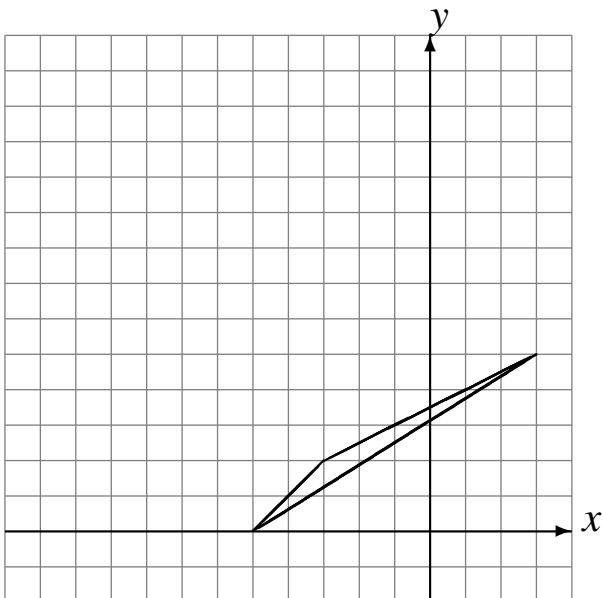

Traslade $(-2, 5)$.
Traslade $(6, 3)$.
Traslade $(3, 5)$.

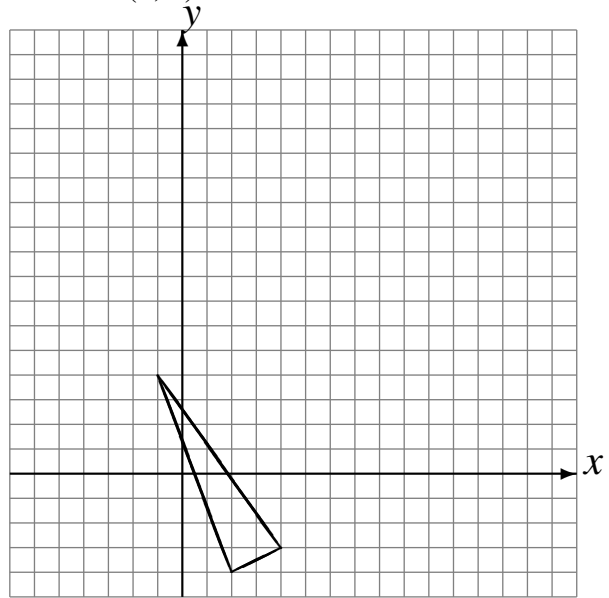

Traslaciones (A) Respuestas

Dibuje cada figura trasladada.

Traslade $(-6, -3)$.
Traslade $(-1, 0)$.
Traslade $(4, -5)$.

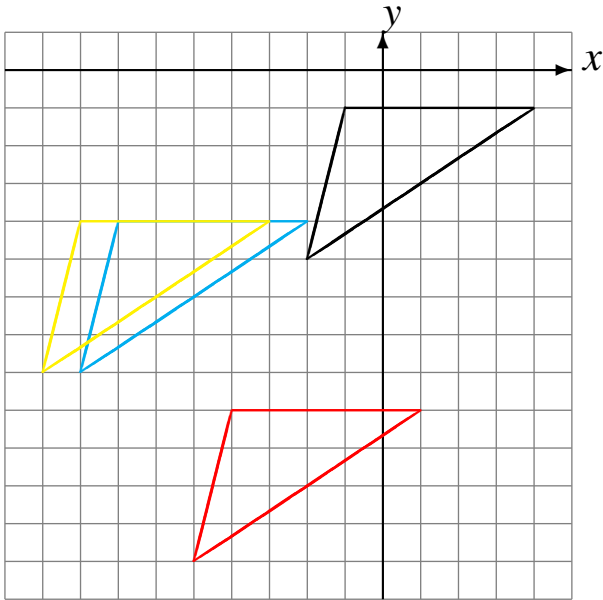

Traslade $(0, 3)$.
Traslade $(5, -5)$.
Traslade $(4, -5)$.

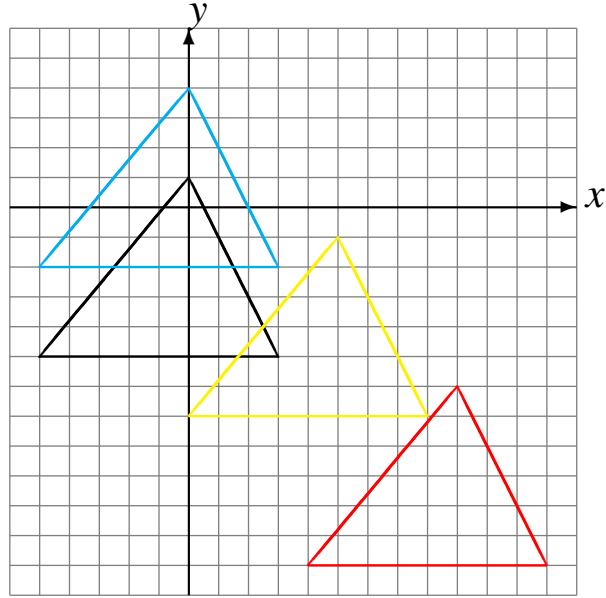

Traslade $(-6, 5)$.
Traslade $(1, 1)$.
Traslade $(3, 0)$.

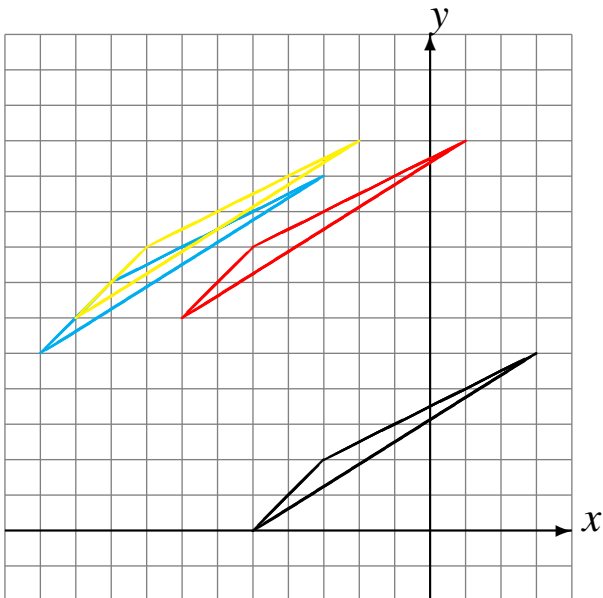

Traslade $(-2, 5)$.
Traslade $(6, 3)$.
Traslade $(3, 5)$.

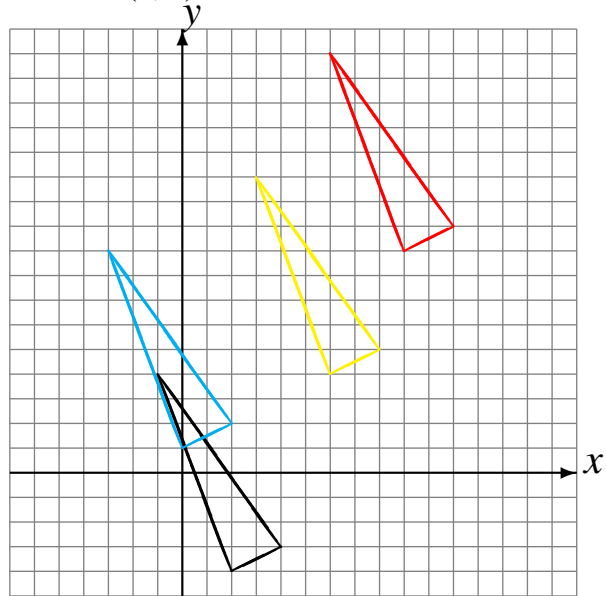

Traslaciones (B)

Dibuje cada figura trasladada.

Traslade (0, -1).

Traslade (0, 1).

Traslade (2, 3).

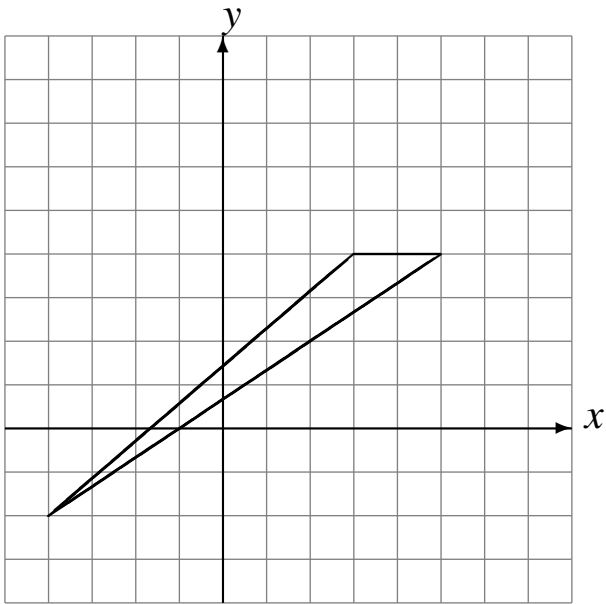

Traslade (-3, 2).

Traslade (2, 2).

Traslade (2, 6).

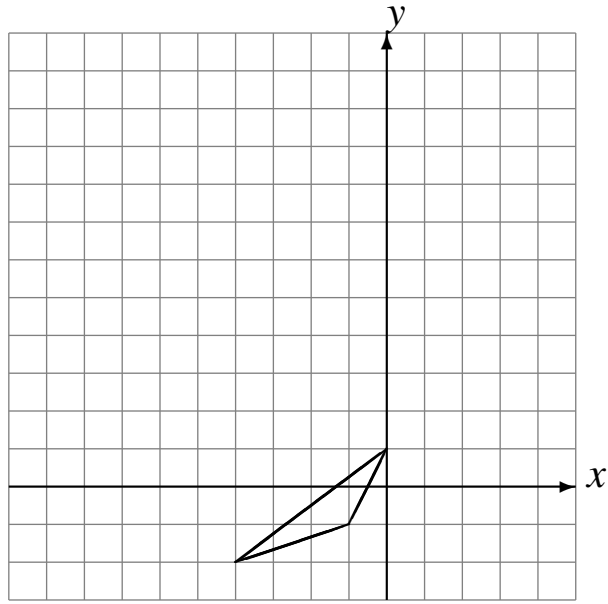

Traslade (6, 0).

Traslade (1, -3).

Traslade (2, -5).

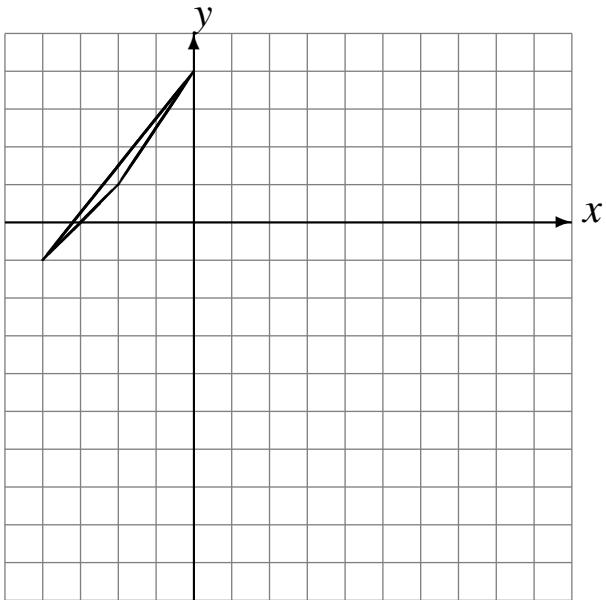

Traslade (4, -2).

Traslade (-6, 4).

Traslade (5, 2).

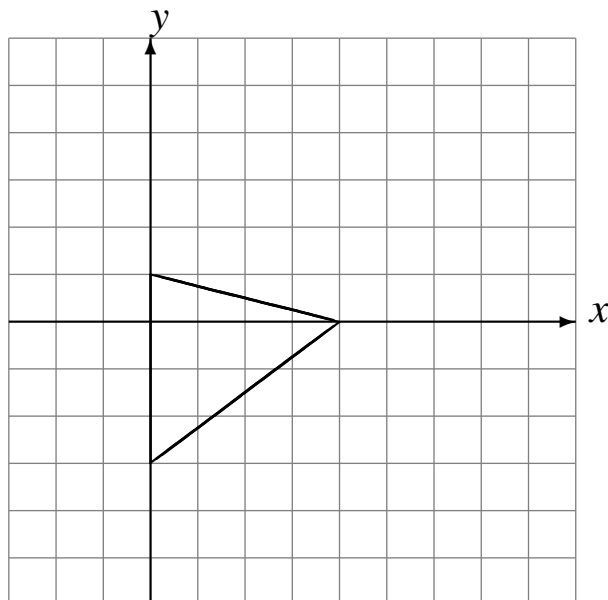

Traslaciones (B) Respuestas

Dibuje cada figura trasladada.

Traslade (0, -1).
Traslade (0, 1).
Traslade (2, 3).

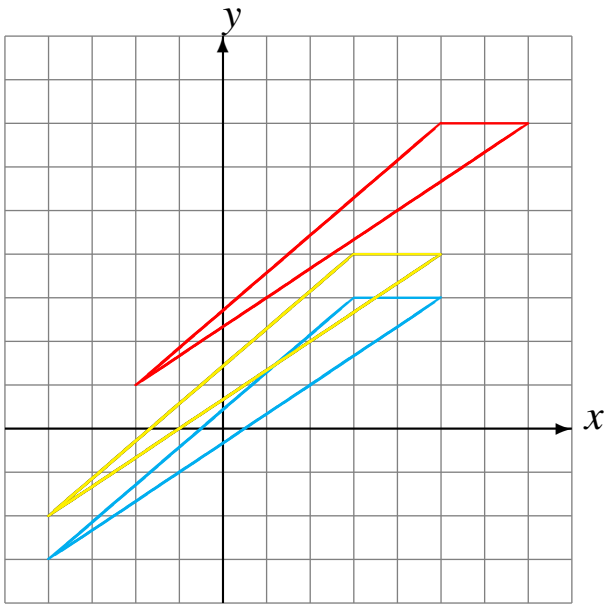

Traslade (-3, 2).
Traslade (2, 2).
Traslade (2, 6).

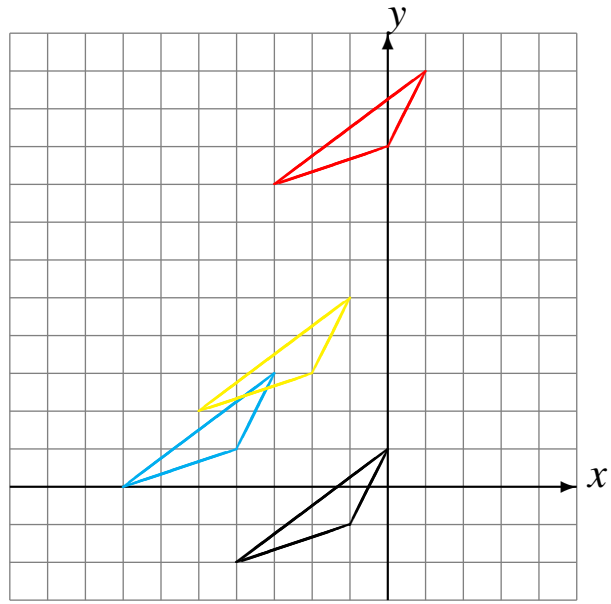

Traslade (6, 0).
Traslade (1, -3).
Traslade (2, -5).

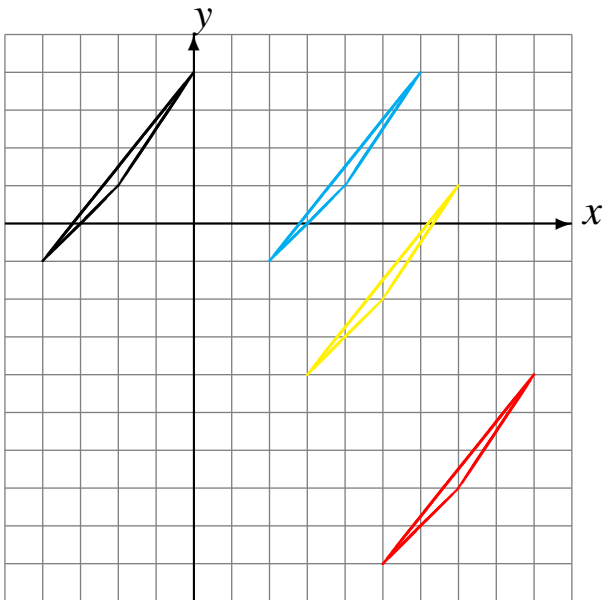

Traslade (4, -2).
Traslade (-6, 4).
Traslade (5, 2).

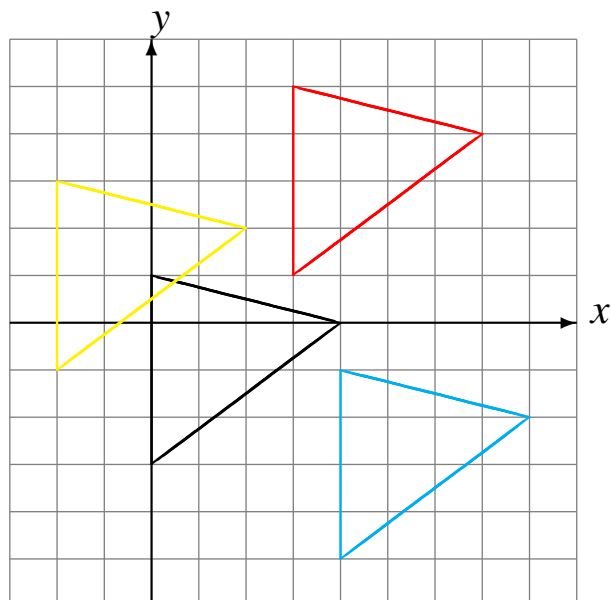

Traslaciones (C)

Dibuje cada figura trasladada.

Traslade $(-5, -5)$.
Traslade $(-3, -1)$.
Traslade $(-6, 3)$.

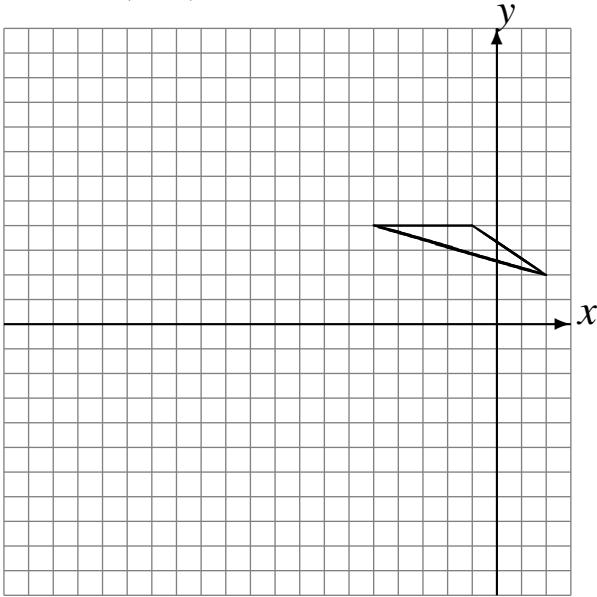

Traslade $(6, -3)$.
Traslade $(-3, -2)$.
Traslade $(1, -1)$.

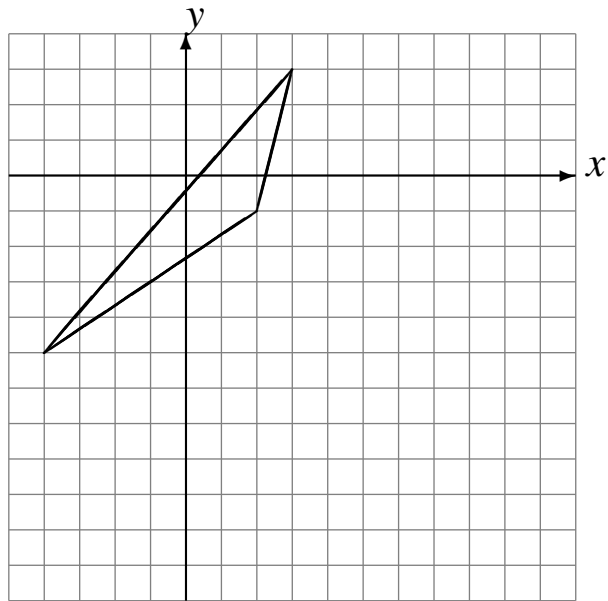

Traslade $(-3, 4)$.
Traslade $(-3, 2)$.
Traslade $(-5, 6)$.

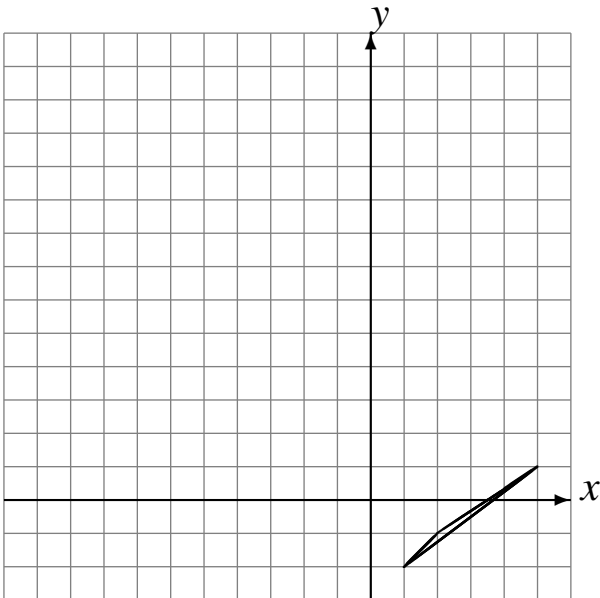

Traslade $(-2, 5)$.
Traslade $(-5, 2)$.
Traslade $(-3, 2)$.

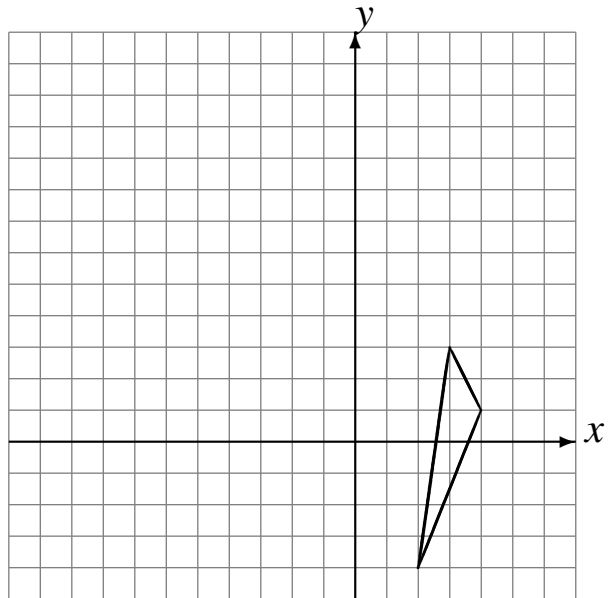

Traslaciones (C) Respuestas

Dibuje cada figura trasladada.

Traslade $(-5, -5)$.
Traslade $(-3, -1)$.
Traslade $(-6, 3)$.

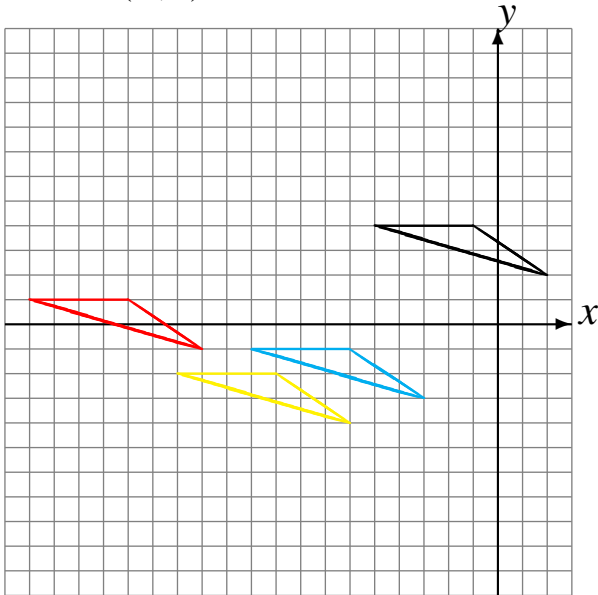

Traslade $(6, -3)$.
Traslade $(-3, -2)$.
Traslade $(1, -1)$.

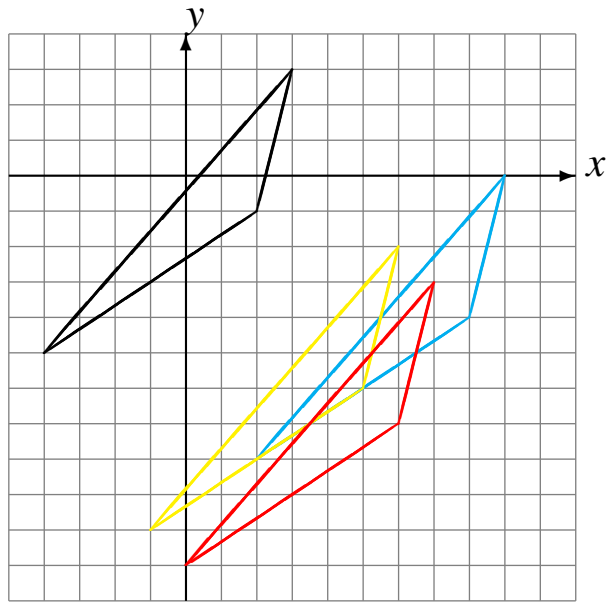

Traslade $(-3, 4)$.
Traslade $(-3, 2)$.
Traslade $(-5, 6)$.

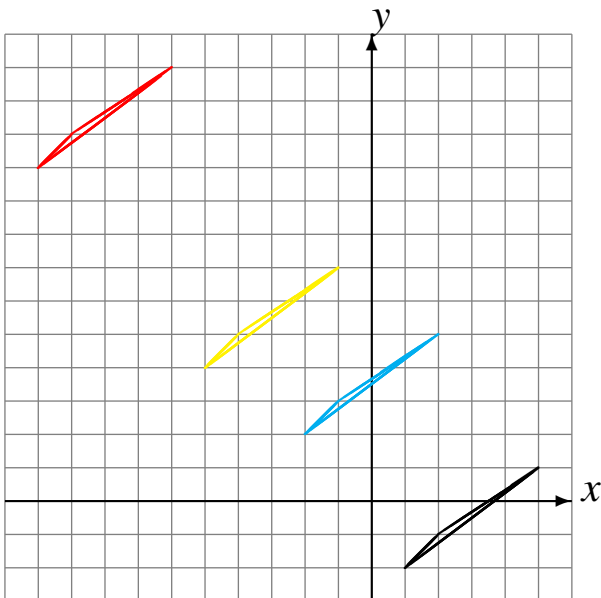

Traslade $(-2, 5)$.
Traslade $(-5, 2)$.
Traslade $(-3, 2)$.

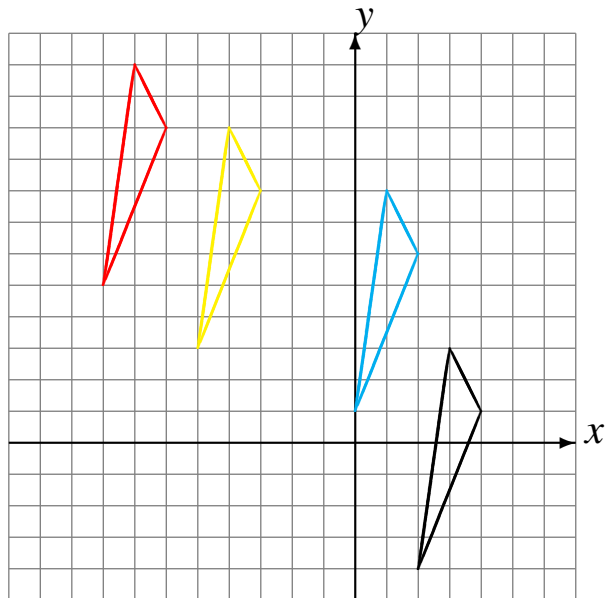

Traslaciones (D)

Dibuje cada figura trasladada.

Traslade $(-1, -1)$.
Traslade $(-2, 6)$.
Traslade $(-1, -1)$.

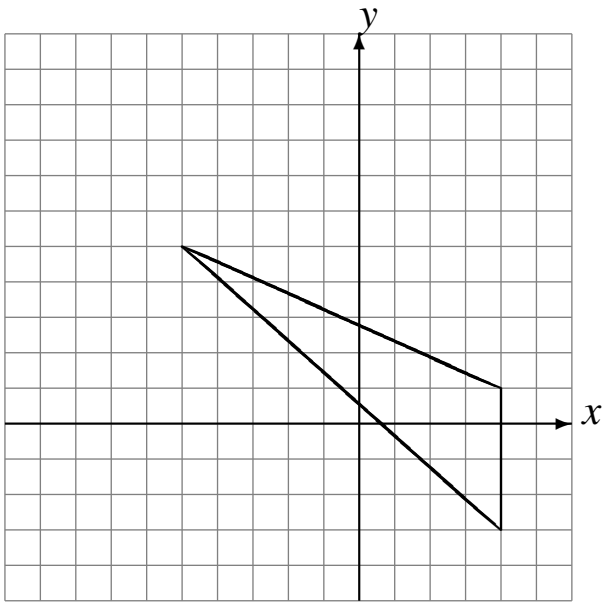

Traslade $(2, -1)$.
Traslade $(-5, 3)$.
Traslade $(4, -4)$.

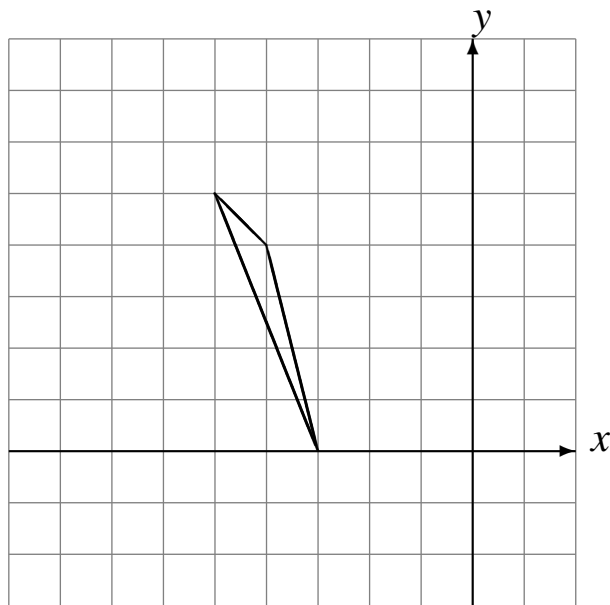

Traslade $(0, -3)$.
Traslade $(1, 4)$.
Traslade $(6, -1)$.

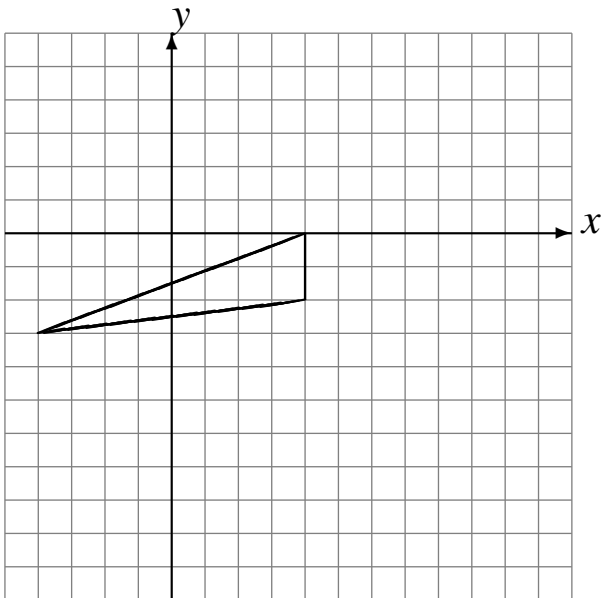

Traslade $(-2, 5)$.
Traslade $(6, -5)$.
Traslade $(0, 6)$.

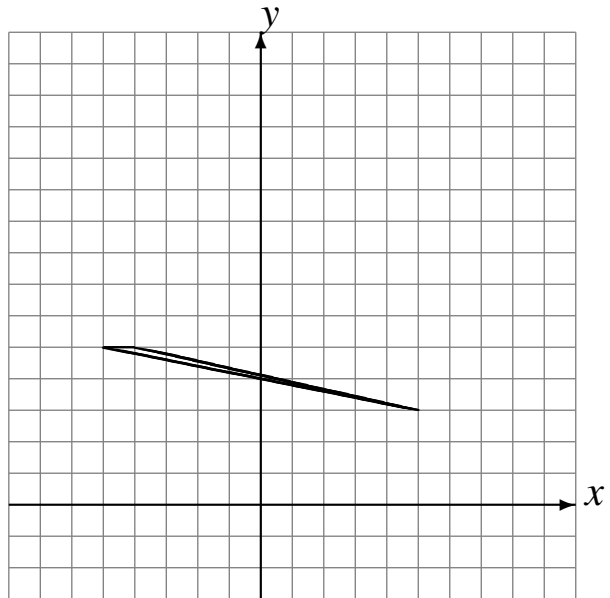

Traslaciones (D) Respuestas

Dibuje cada figura trasladada.

Traslade (-1, -1).
Traslade (-2, 6).
Traslade (-1, -1).

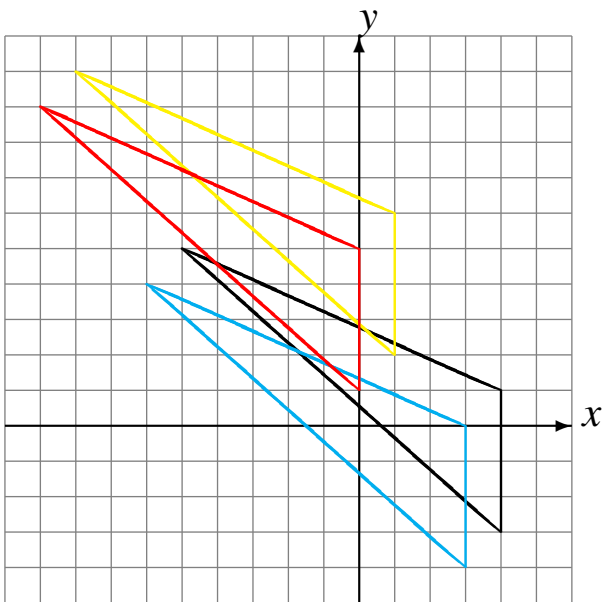

Traslade (2, -1).
Traslade (-5, 3).
Traslade (4, -4).

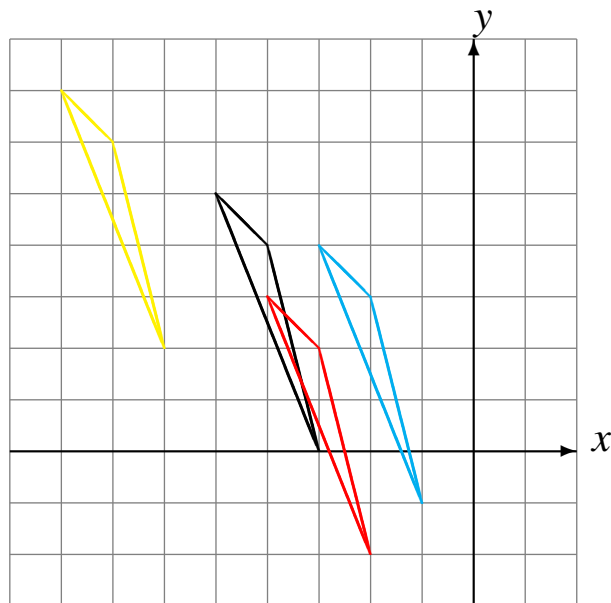

Traslade (0, -3).
Traslade (1, 4).
Traslade (6, -1).

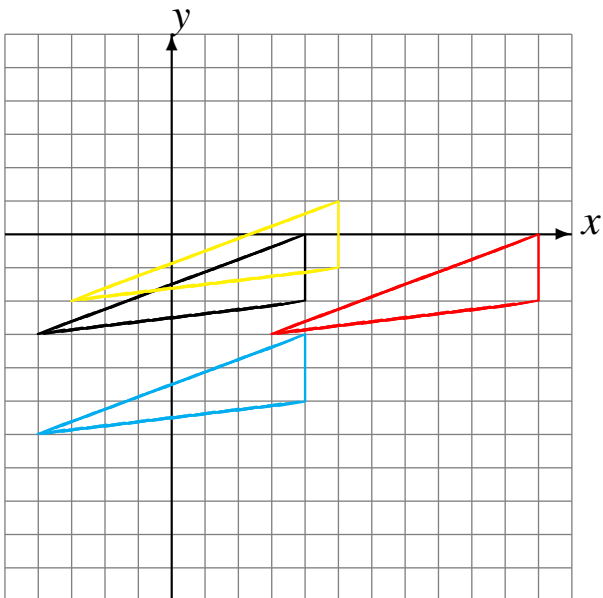

Traslade (-2, 5).
Traslade (6, -5).
Traslade (0, 6).

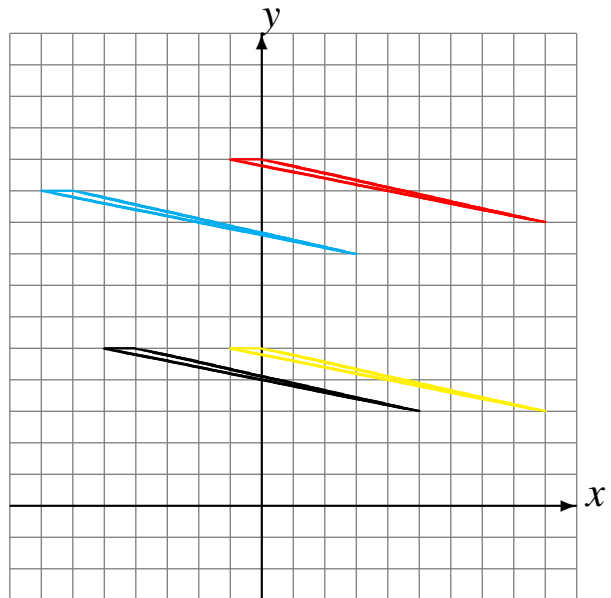

Traslaciones (E)

Dibuje cada figura trasladada.

Traslade (6, -4).
Traslade (1, 5).
Traslade (4, -3).

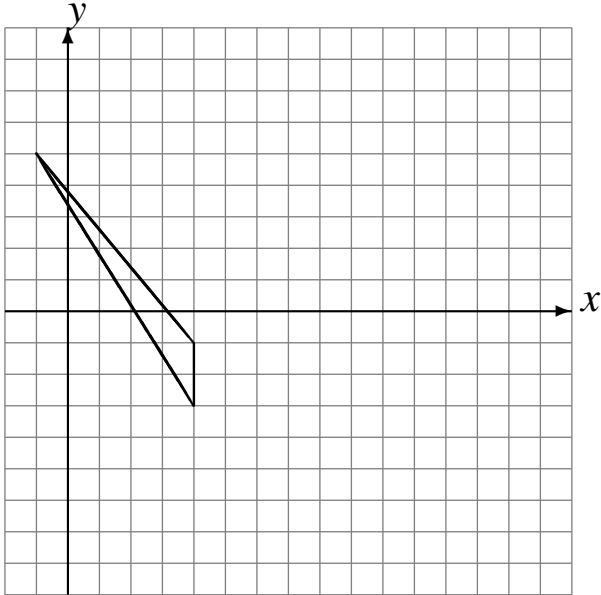

Traslade (6, 3).
Traslade (-3, 1).
Traslade (0, 1).

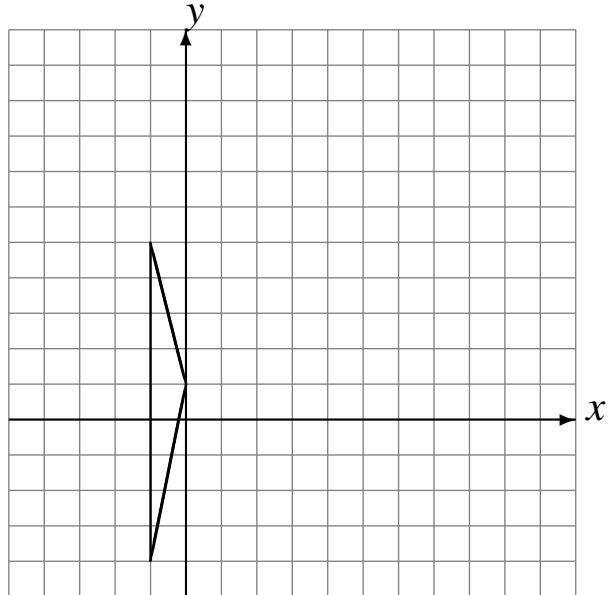

Traslade (-5, -6).
Traslade (-5, -5).
Traslade (-5, -1).

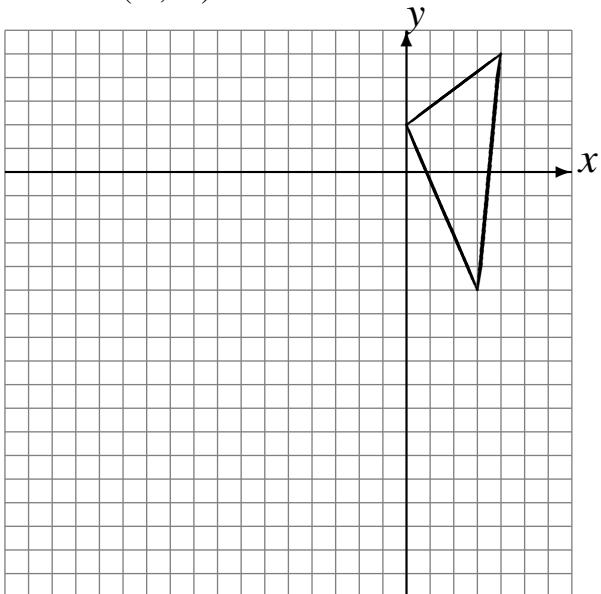

Traslade (-2, -1).
Traslade (-3, -2).
Traslade (-4, 5).

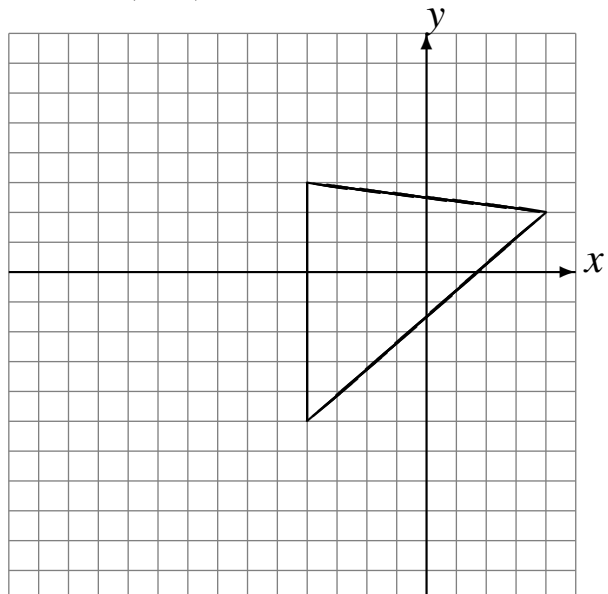

Traslaciones (E) Respuestas

Dibuje cada figura trasladada.

Traslade (6, -4).
Traslade (1, 5).
Traslade (4, -3).

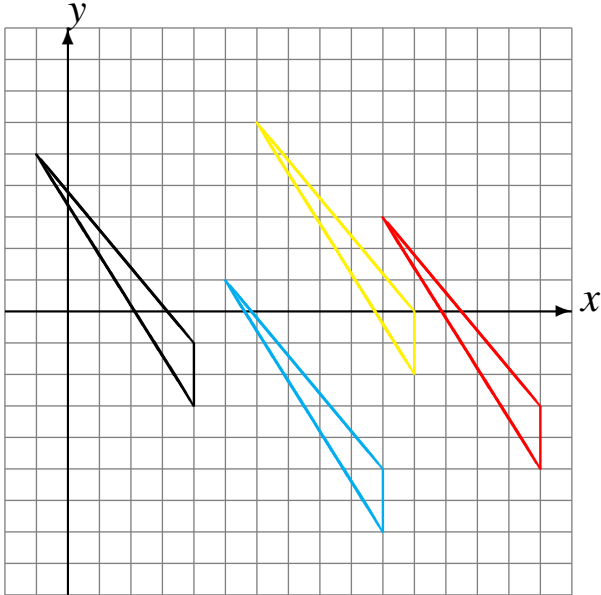

Traslade (6, 3).
Traslade (-3, 1).
Traslade (0, 1).

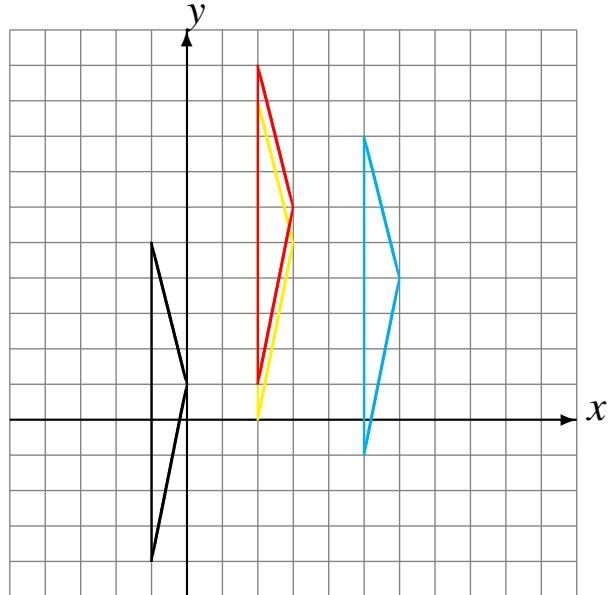

Traslade (-5, -6).
Traslade (-5, -5).
Traslade (-5, -1).

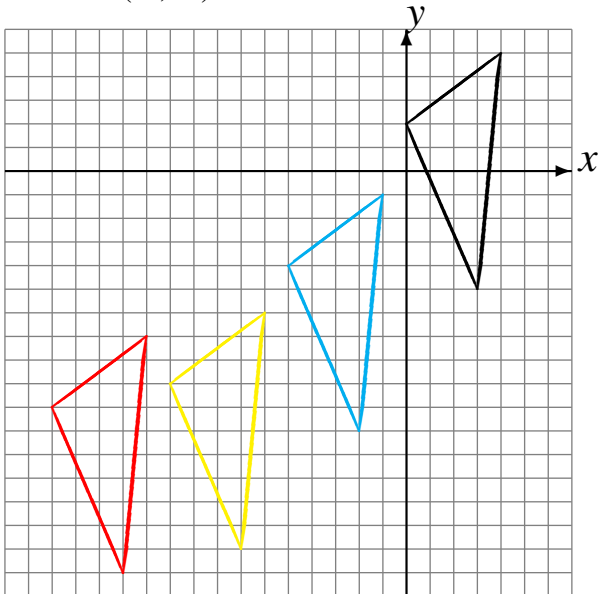

Traslade (-2, -1).
Traslade (-3, -2).
Traslade (-4, 5).

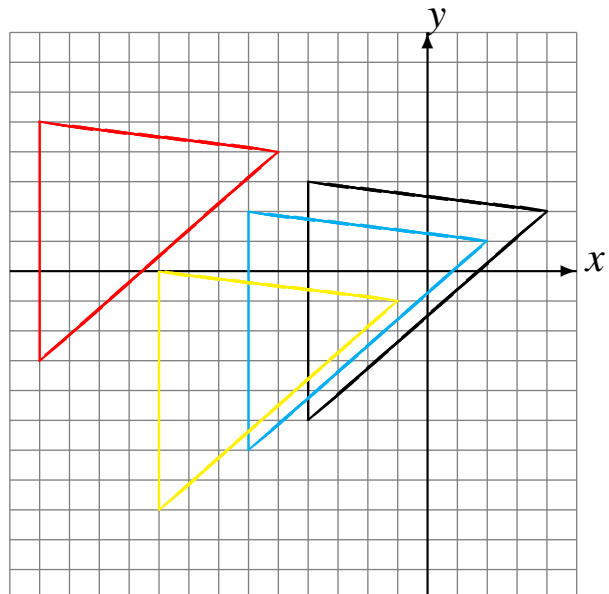

Traslaciones (F)

Dibuje cada figura trasladada.

Traslade (-6, -6).

Traslade (-5, -5).

Traslade (-3, -5).

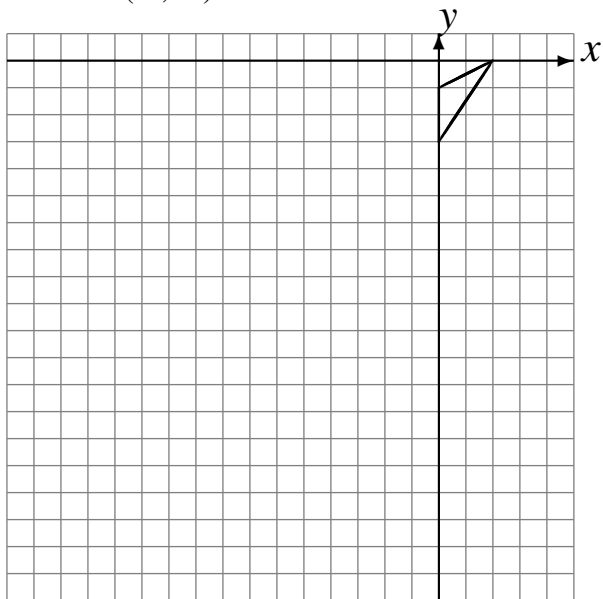

Traslade (1, 1).

Traslade (1, -1).

Traslade (-3, 5).

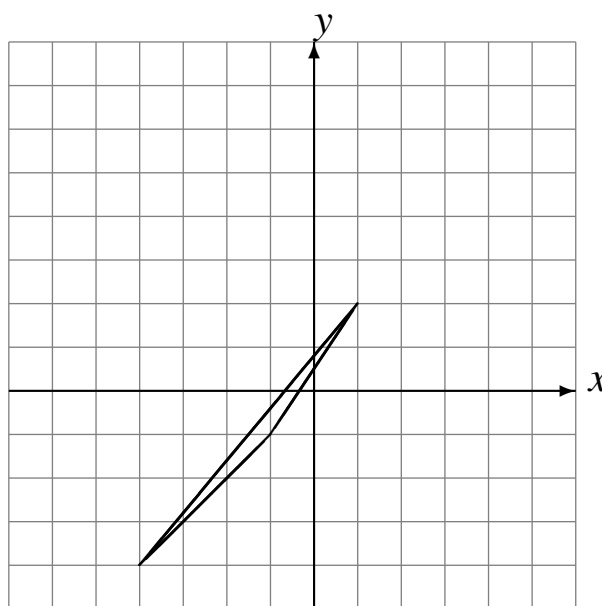

Traslade (-4, -5).

Traslade (0, -5).

Traslade (6, -6).

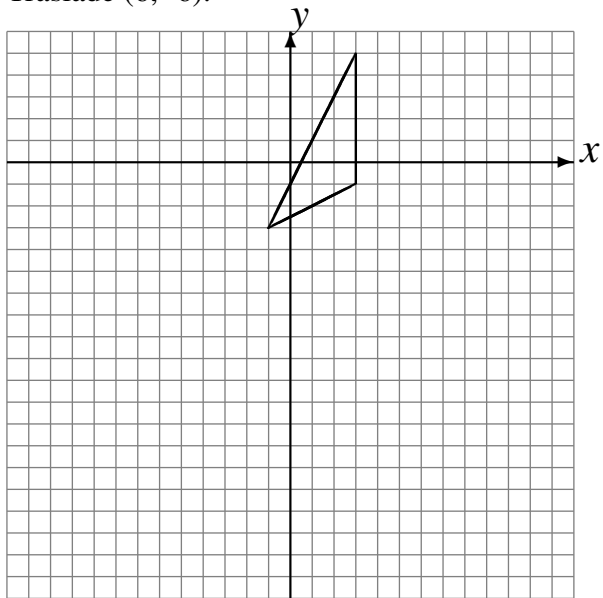

Traslade (2, 5).

Traslade (-2, -1).

Traslade (4, -5).

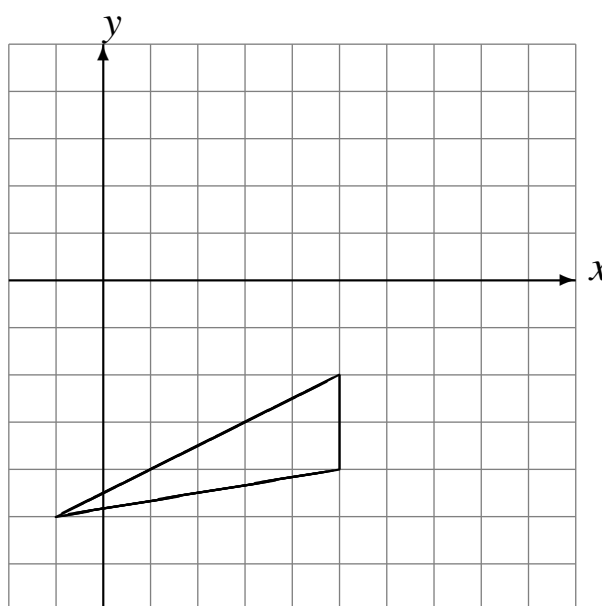

Traslaciones (F) Respuestas

Dibuje cada figura trasladada.

Traslade (-6, -6).
Traslade (-5, -5).
Traslade (-3, -5).

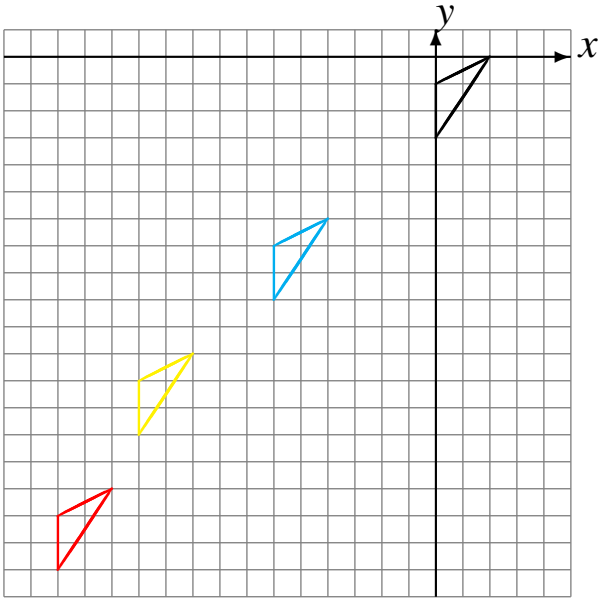

Traslade (1, 1).
Traslade (1, -1).
Traslade (-3, 5).

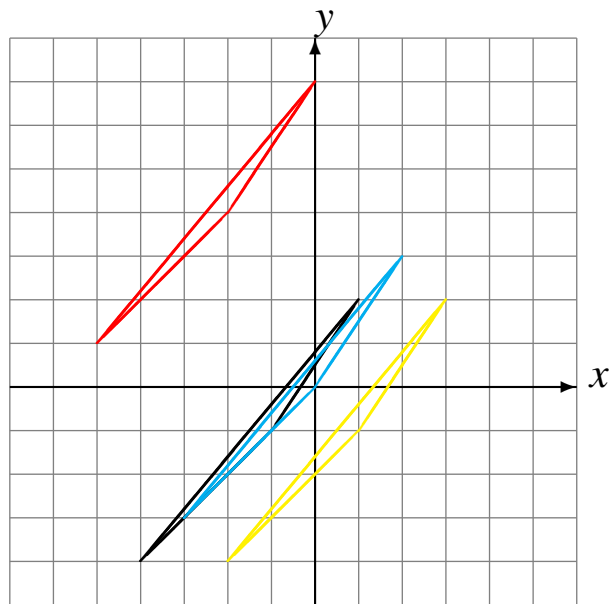

Traslade (-4, -5).
Traslade (0, -5).
Traslade (6, -6).

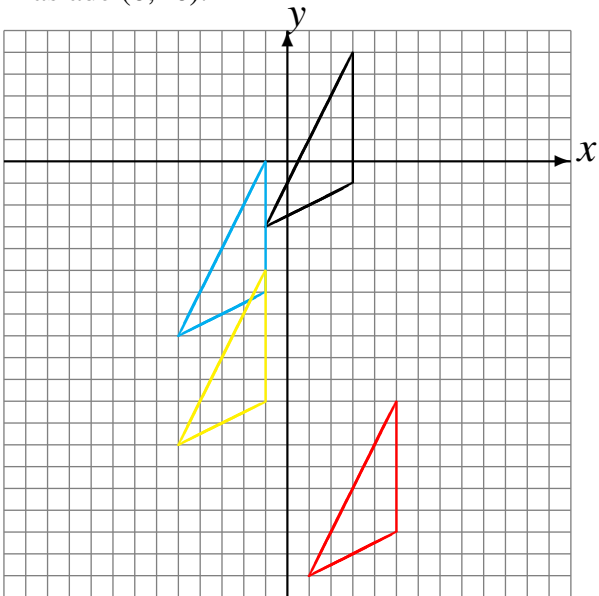

Traslade (2, 5).
Traslade (-2, -1).
Traslade (4, -5).

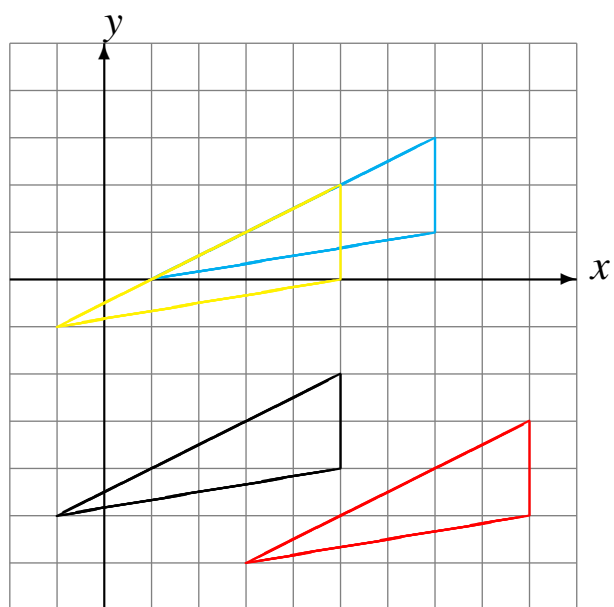

Traslaciones (G)

Dibuje cada figura trasladada.

Traslade (-1, -2).

Traslade (-3, -6).

Traslade (1, -3).

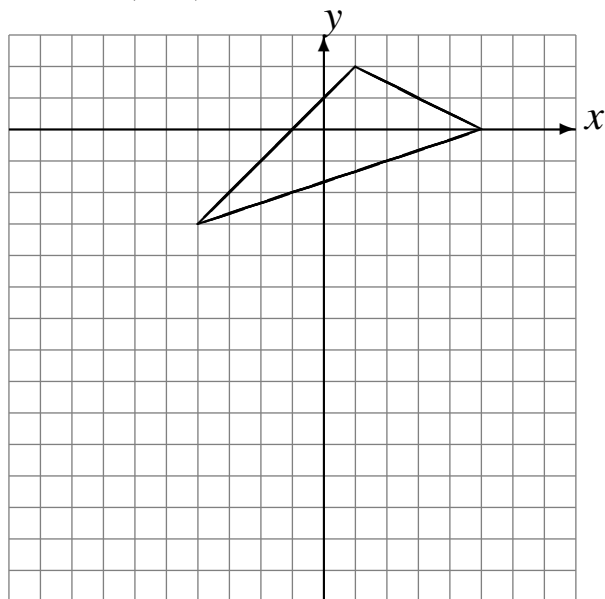

Traslade (-1, -4).

Traslade (-5, 0).

Traslade (6, 5).

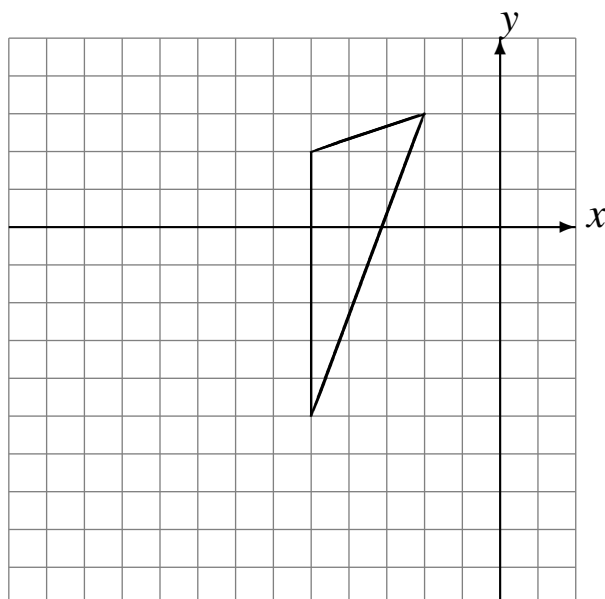

Traslade (4, 5).

Traslade (5, -1).

Traslade (-3, -2).

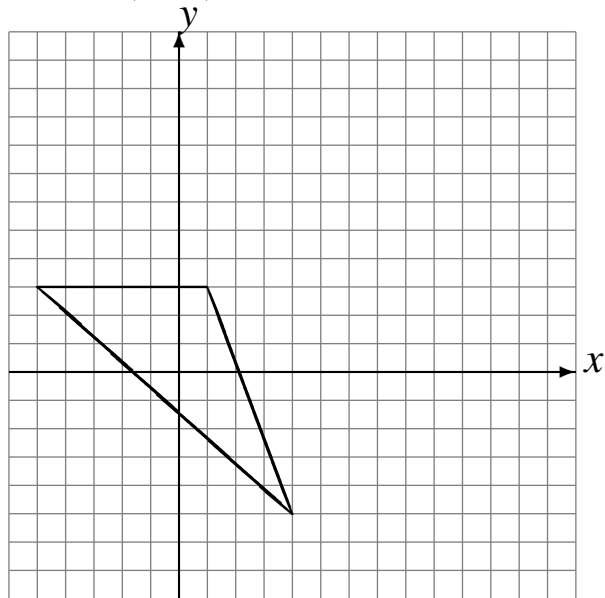

Traslade (6, 1).

Traslade (-4, 6).

Traslade (1, 4).

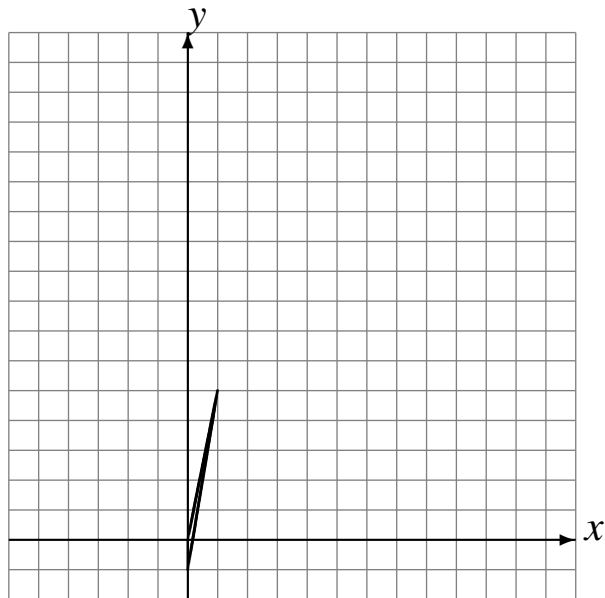

Traslaciones (G) Respuestas

Dibuje cada figura trasladada.

Traslade (-1, -2).
Traslade (-3, -6).
Traslade (1, -3).

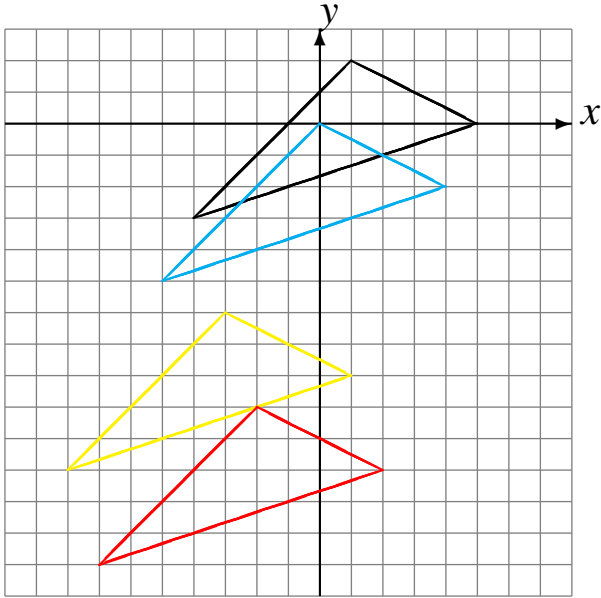

Traslade (-1, -4).
Traslade (-5, 0).
Traslade (6, 5).

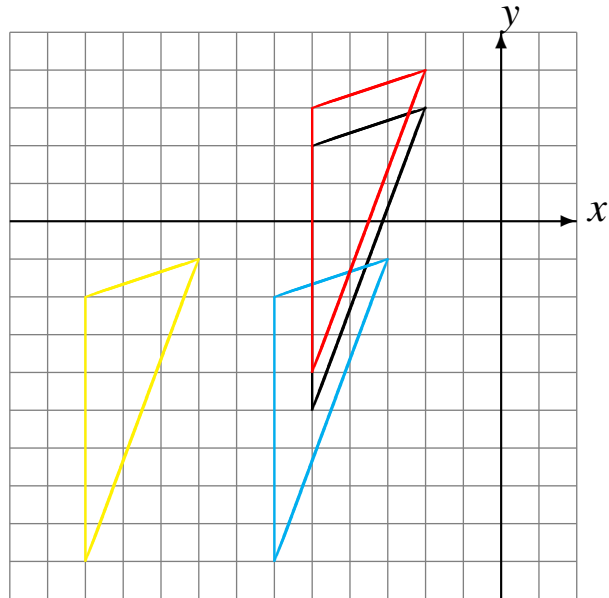

Traslade (4, 5).
Traslade (5, -1).
Traslade (-3, -2).

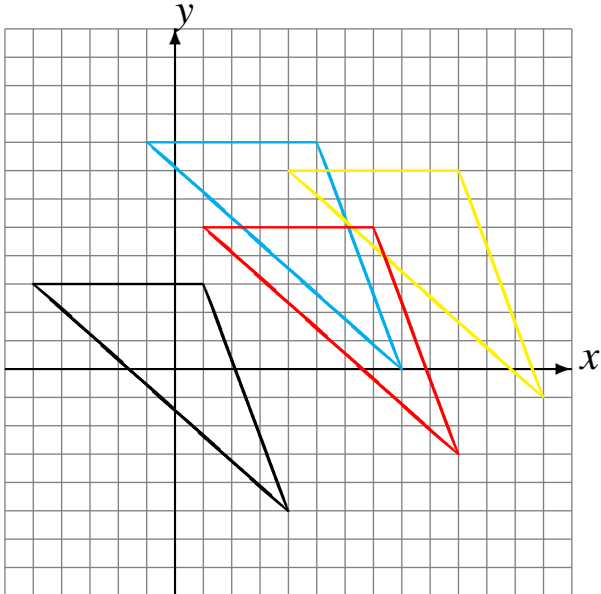

Traslade (6, 1).
Traslade (-4, 6).
Traslade (1, 4).

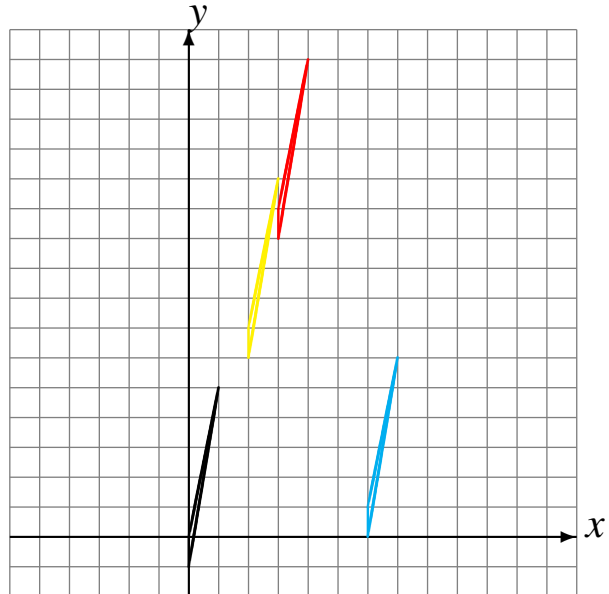

Traslaciones (H)

Dibuje cada figura trasladada.

Traslade $(-5, 0)$.
Traslade $(5, -5)$.
Traslade $(1, -3)$.

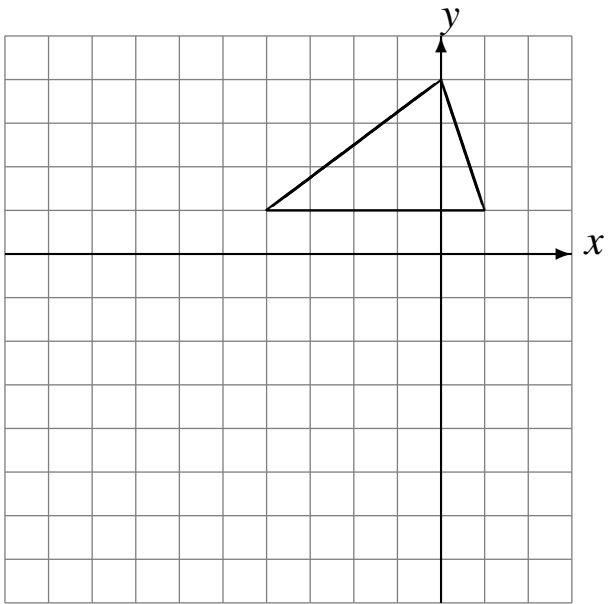

Traslade $(-4, 4)$.
Traslade $(-4, 1)$.
Traslade $(1, 5)$.

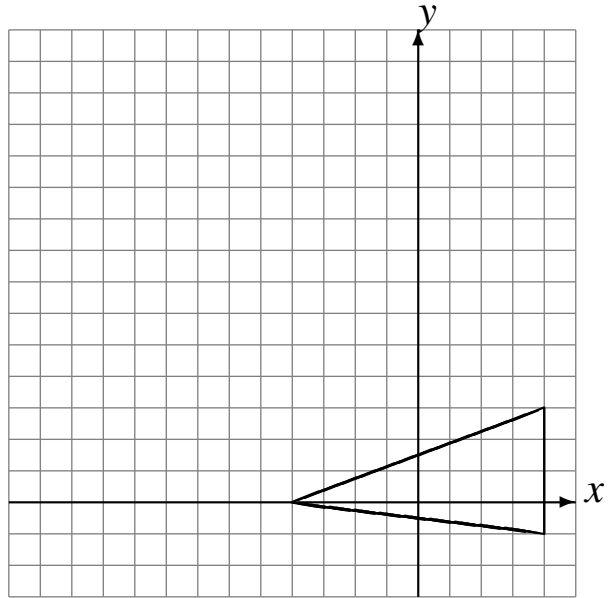

Traslade $(-2, 3)$.
Traslade $(4, -6)$.
Traslade $(6, 0)$.

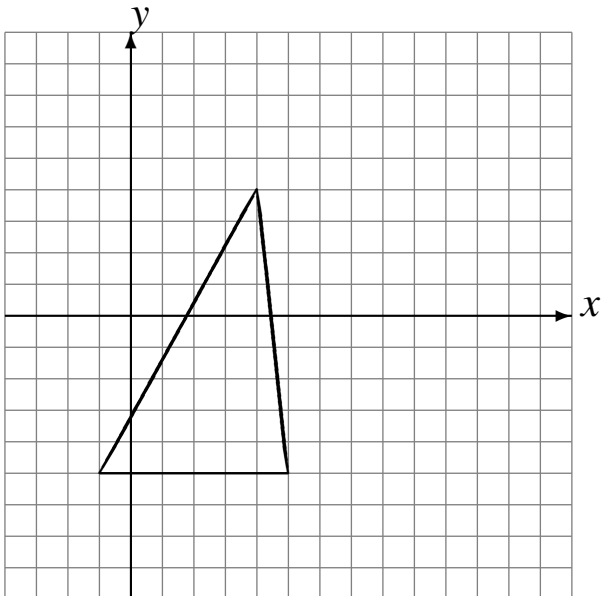

Traslade $(4, -2)$.
Traslade $(0, 5)$.
Traslade $(4, -4)$.

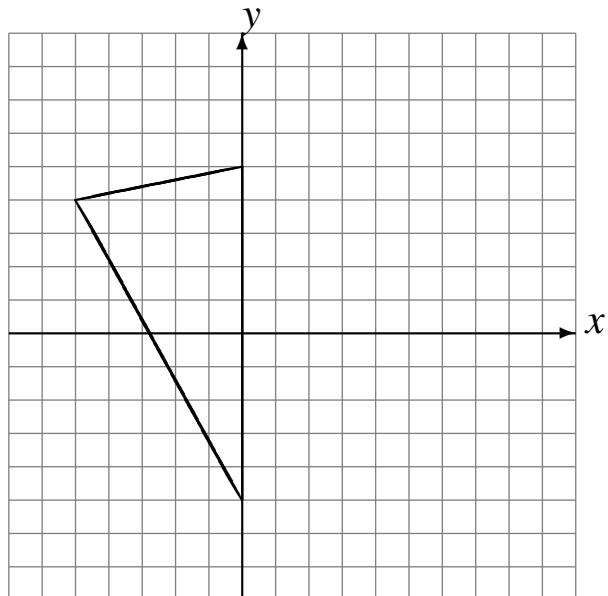

Traslaciones (H) Respuestas

Dibuje cada figura trasladada.

Traslade (-5, 0).
Traslade (5, -5).
Traslade (1, -3).

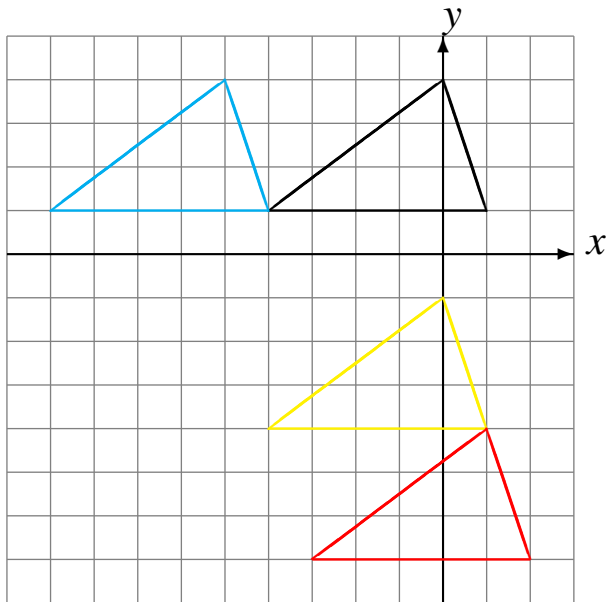

Traslade (-4, 4).
Traslade (-4, 1).
Traslade (1, 5).

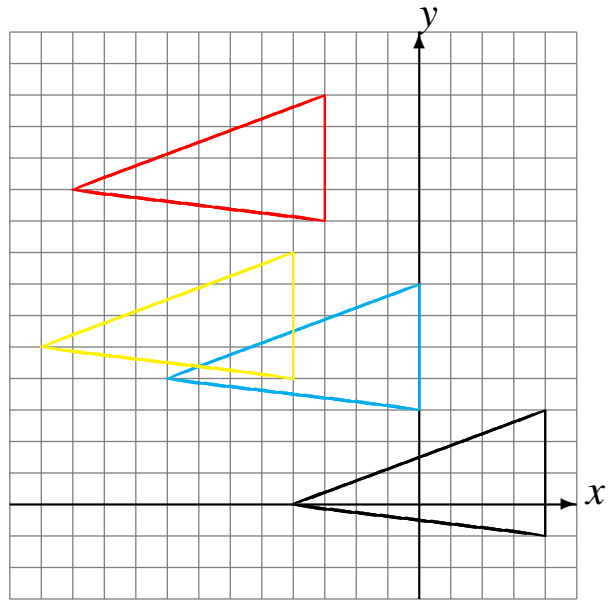

Traslade (-2, 3).
Traslade (4, -6).
Traslade (6, 0).

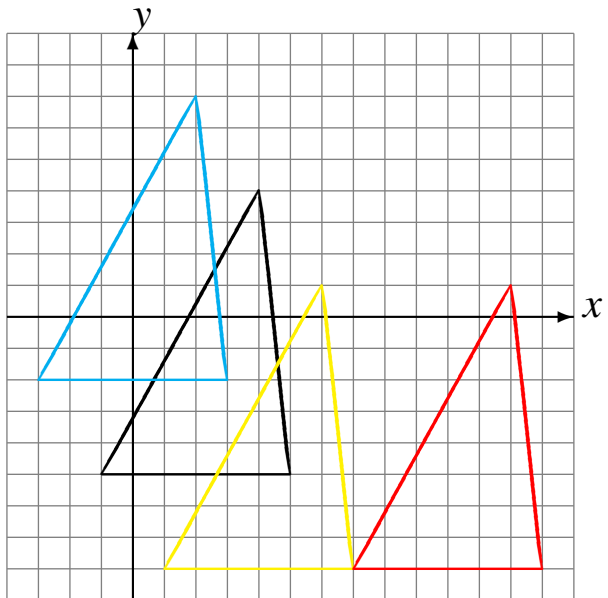

Traslade (4, -2).
Traslade (0, 5).
Traslade (4, -4).

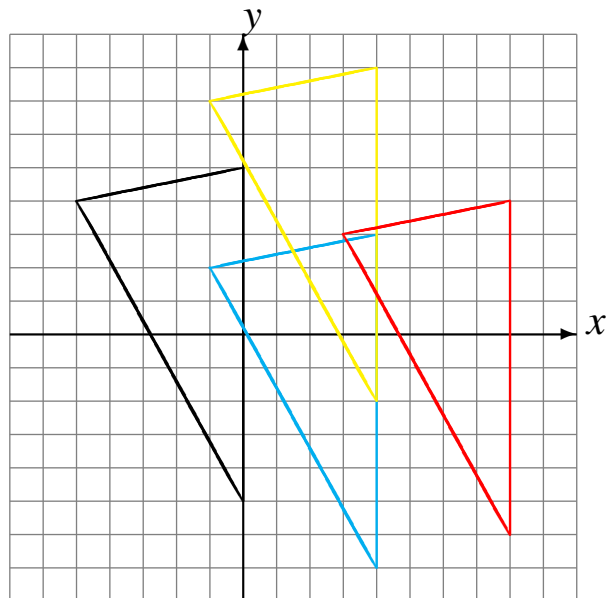

Traslaciones (I)

Dibuje cada figura trasladada.

Traslade (-1, 1).
Traslade (-4, 3).
Traslade (-3, 0).

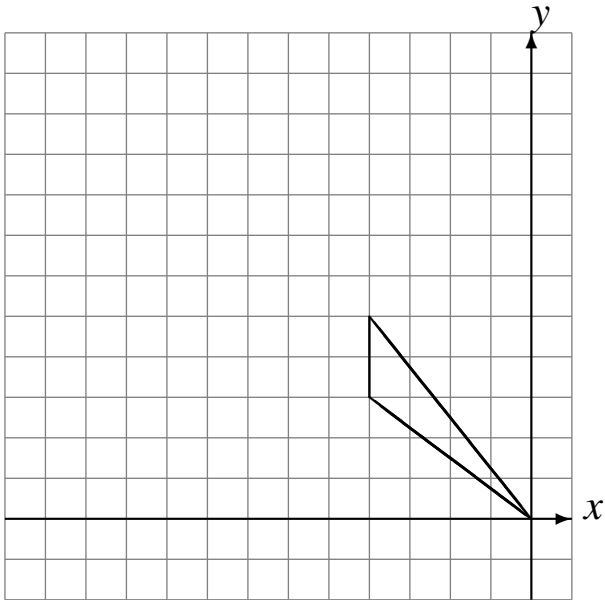

Traslade (5, 6).
Traslade (-4, 4).
Traslade (5, -6).

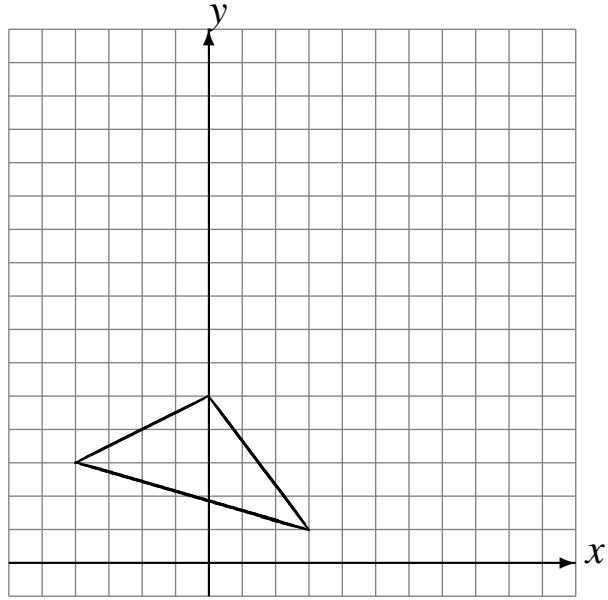

Traslade (2, -5).
Traslade (-5, -5).
Traslade (-3, 0).

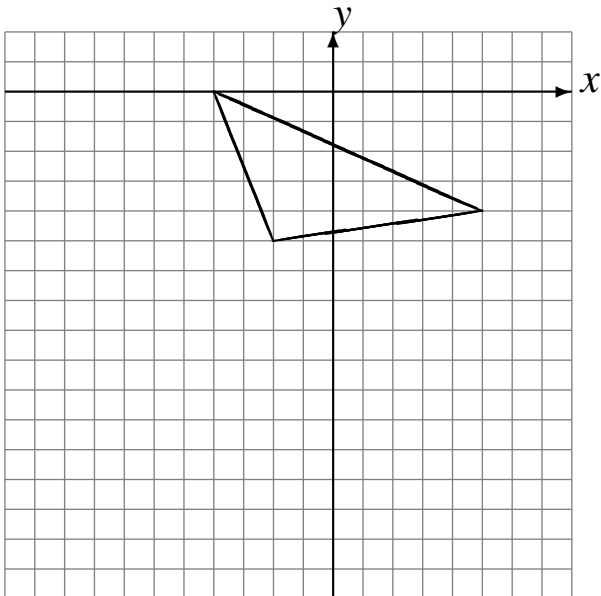

Traslade (0, 5).
Traslade (-2, 6).
Traslade (6, -1).

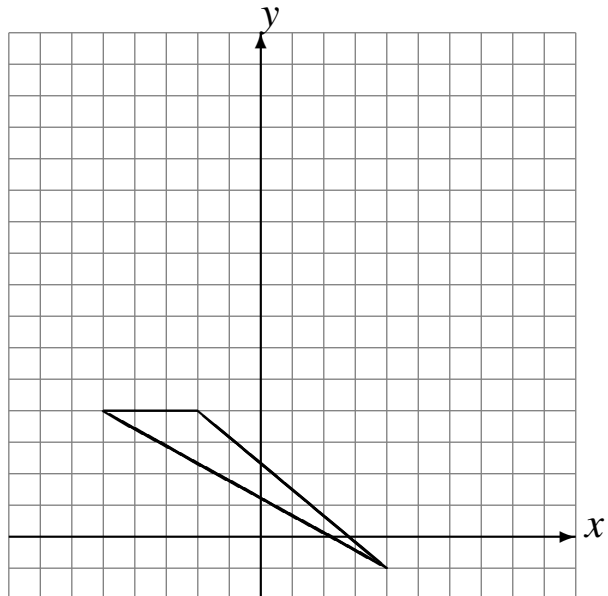

Traslaciones (I) Respuestas

Dibuje cada figura trasladada.

Traslade (-1, 1).
Traslade (-4, 3).
Traslade (-3, 0).

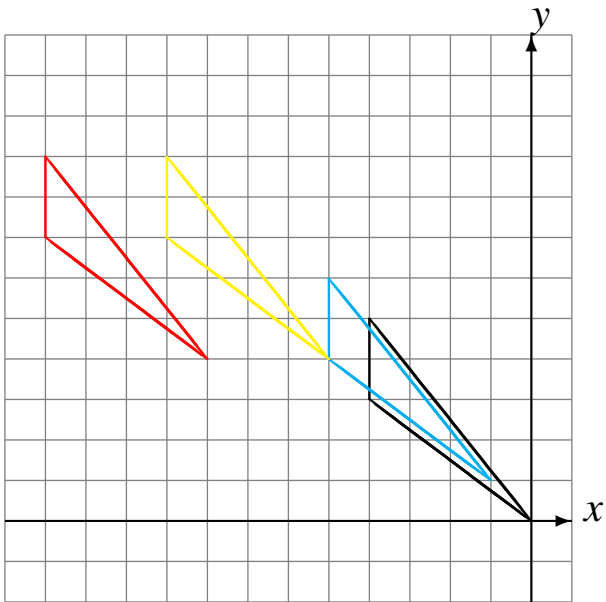

Traslade (5, 6).
Traslade (-4, 4).
Traslade (5, -6).

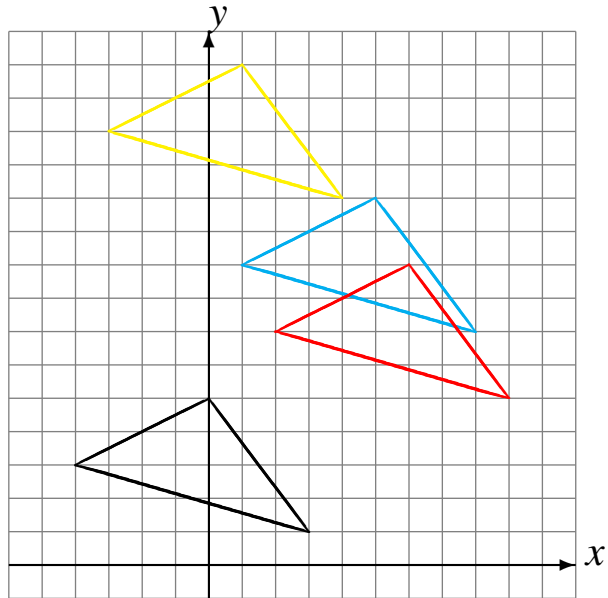

Traslade (2, -5).
Traslade (-5, -5).
Traslade (-3, 0).

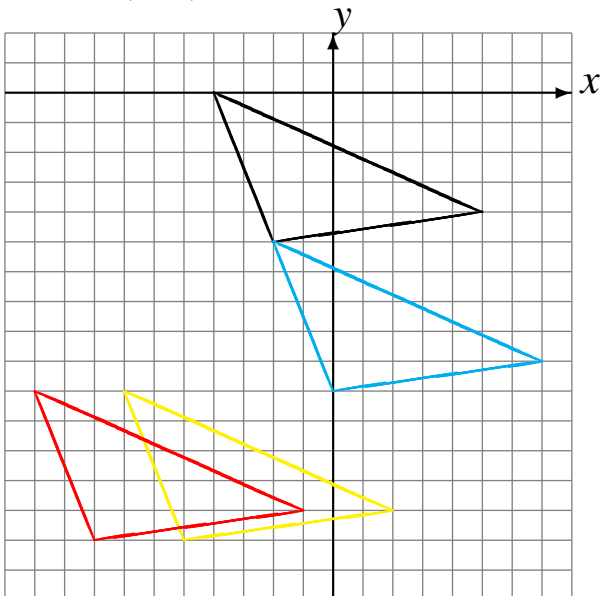

Traslade (0, 5).
Traslade (-2, 6).
Traslade (6, -1).

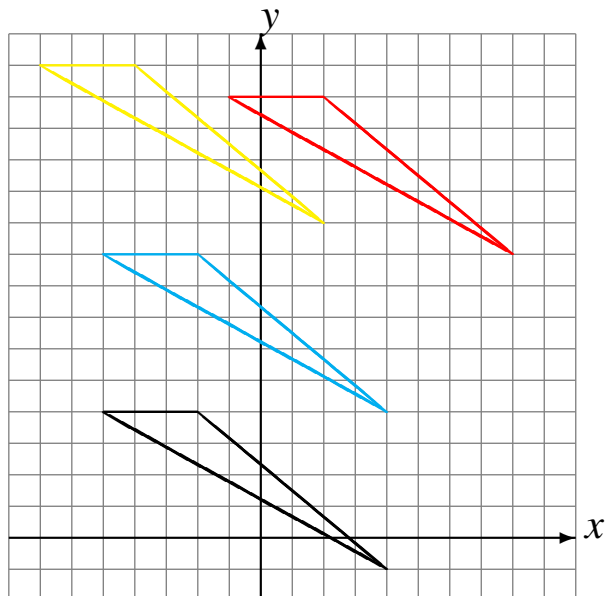

Traslaciones (J)

Dibuje cada figura trasladada.

Traslade (3, 3).
Traslade (-2, 1).
Traslade (6, -5).

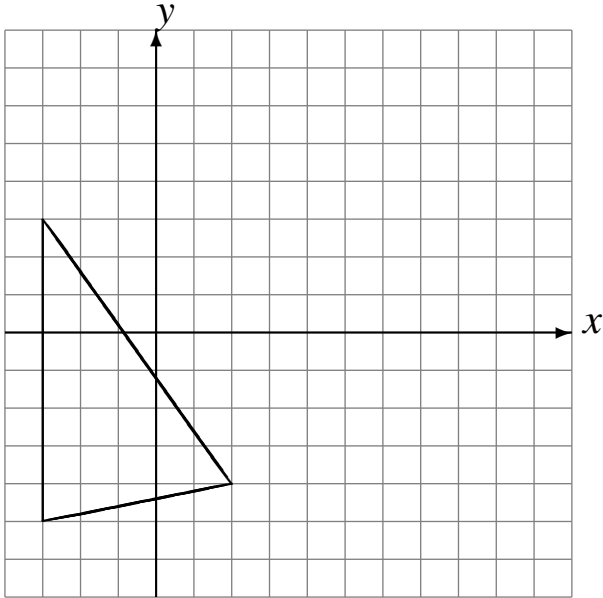

Traslade (1, -3).
Traslade (-6, -4).
Traslade (-4, 5).

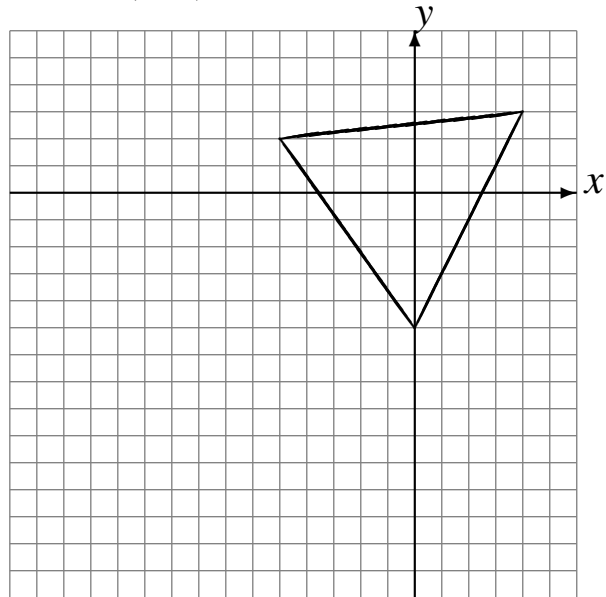

Traslade (0, -1).
Traslade (5, -3).
Traslade (1, 3).

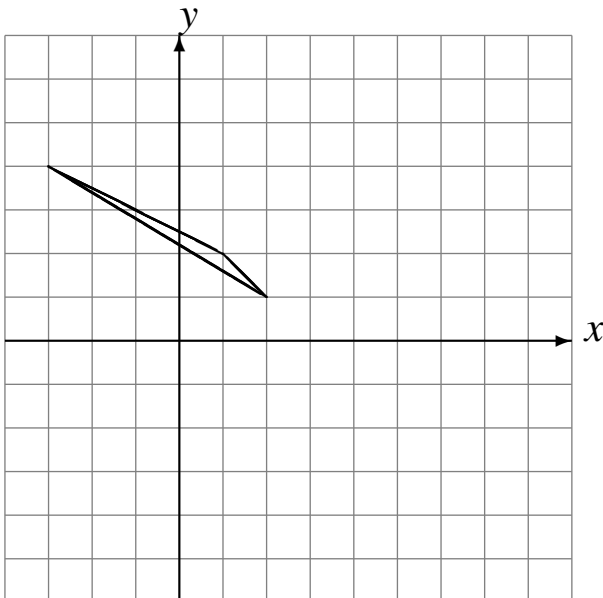

Traslade (-4, -6).
Traslade (-3, 5).
Traslade (4, -1).

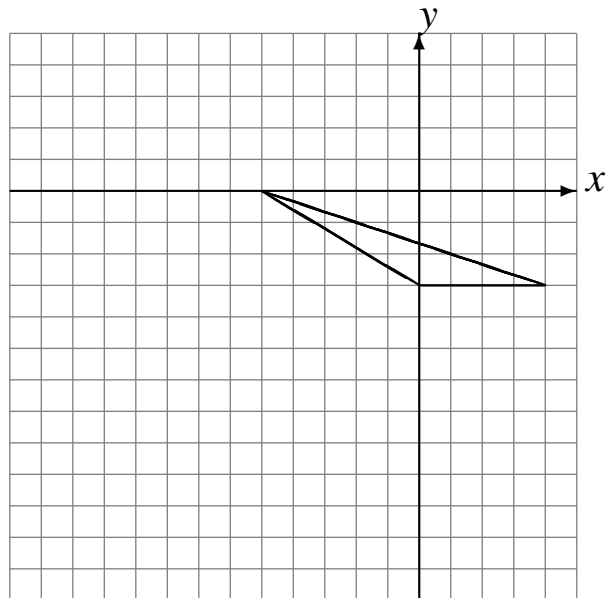

Traslaciones (J) Respuestas

Dibuje cada figura trasladada.

- Traslade (3, 3).
- Traslade (-2, 1).
- Traslade (6, -5).

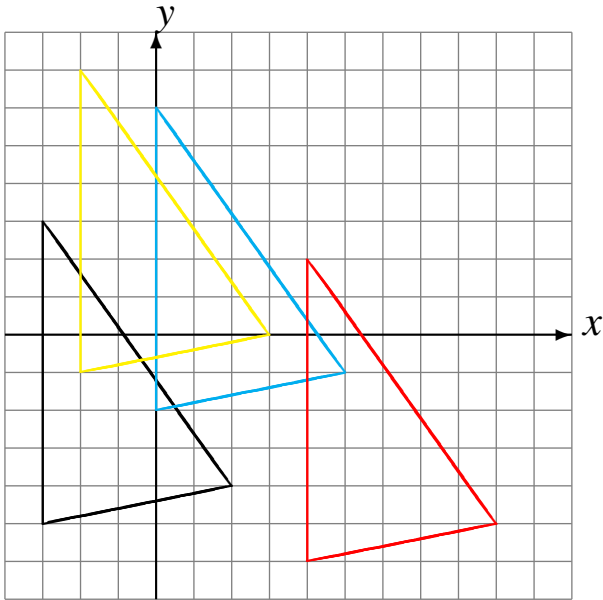

- Traslade (1, -3).
- Traslade (-6, -4).
- Traslade (-4, 5).

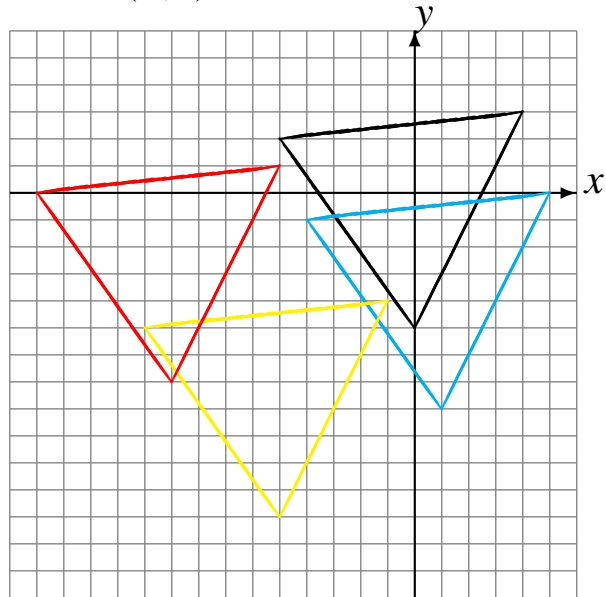

- Traslade (0, -1).
- Traslade (5, -3).
- Traslade (1, 3).

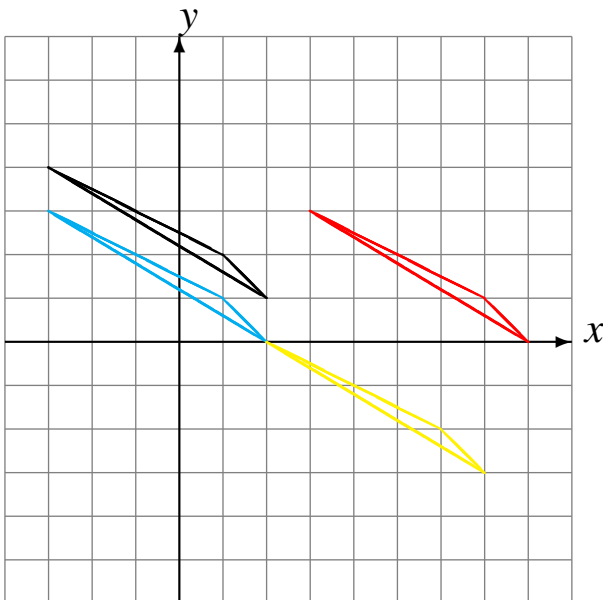

- Traslade (-4, -6).
- Traslade (-3, 5).
- Traslade (4, -1).

