

Traslaciones (A)

Dibuje cada figura trasladada.

Traslade $(-5, -5)$.

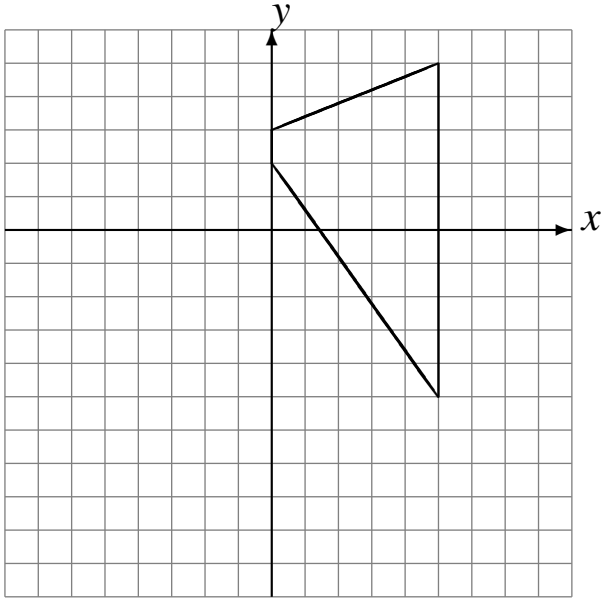

Traslade $(-5, 4)$.

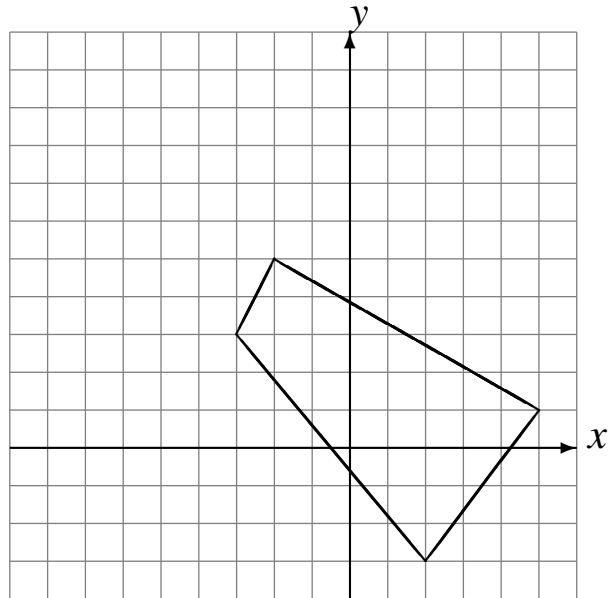

Traslade $(1, -5)$.

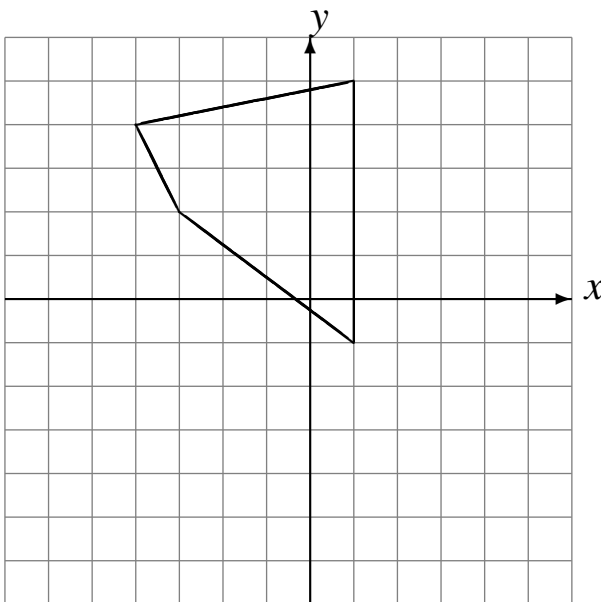

Traslade $(-3, 0)$.

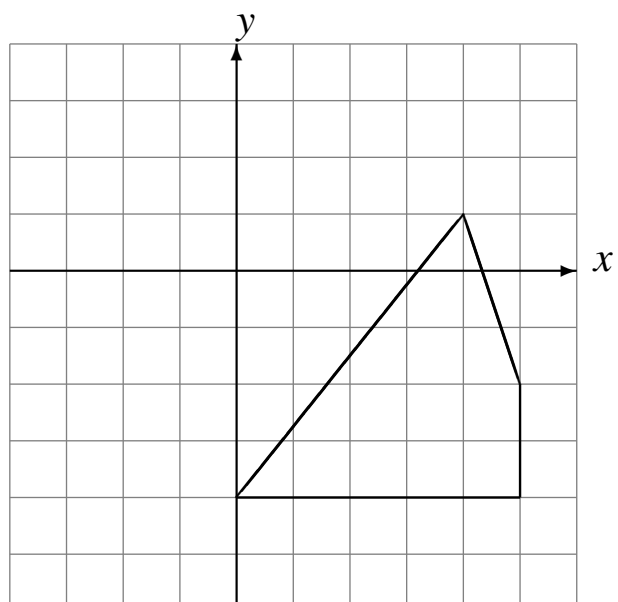

Traslaciones (A) Respuestas

Dibuje cada figura trasladada.

Traslade $(-5, -5)$.

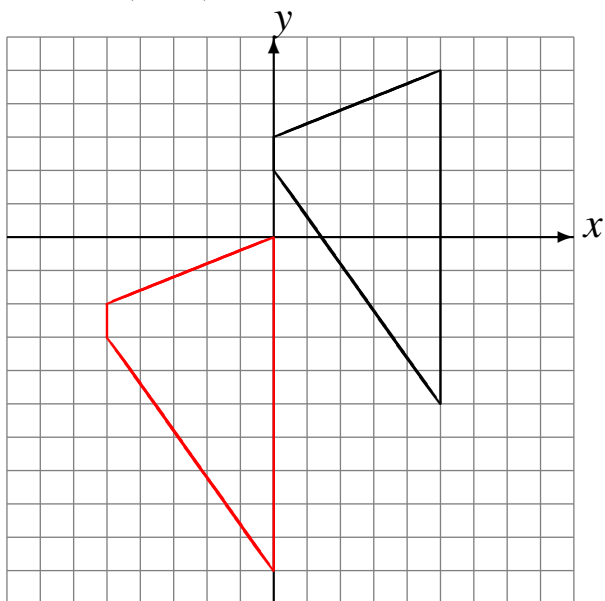

Traslade $(-5, 4)$.

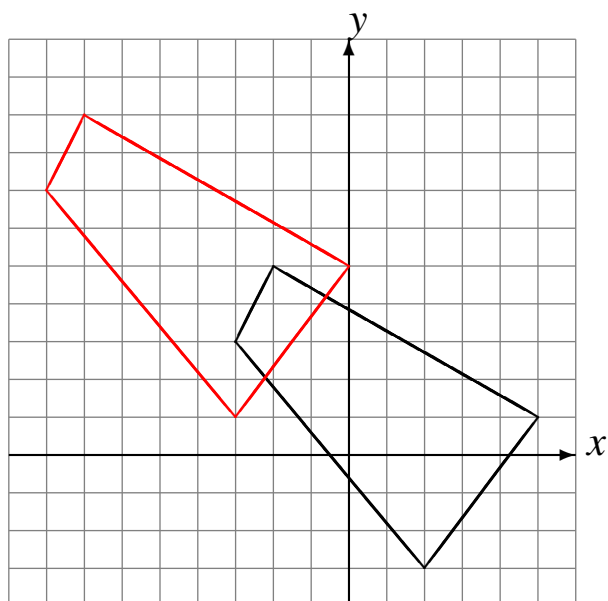

Traslade $(1, -5)$.

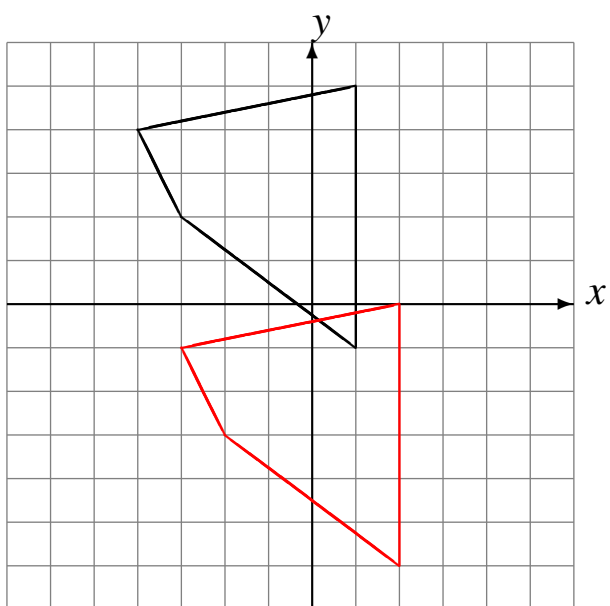

Traslade $(-3, 0)$.

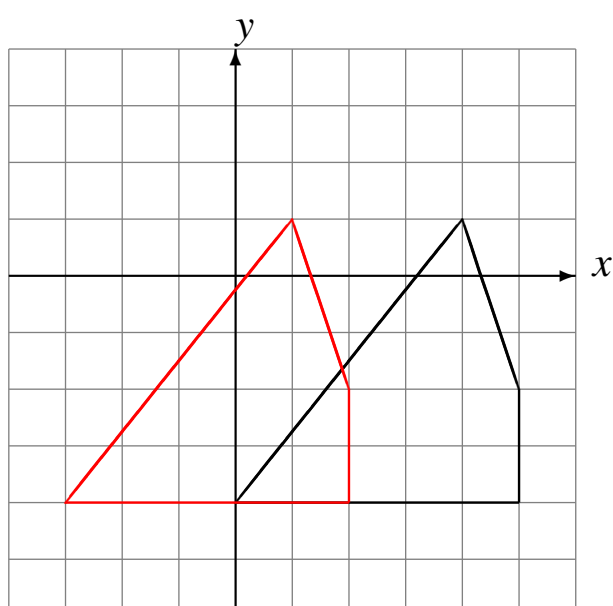

Traslaciones (B)

Dibuje cada figura trasladada.

Traslade (3, -2).

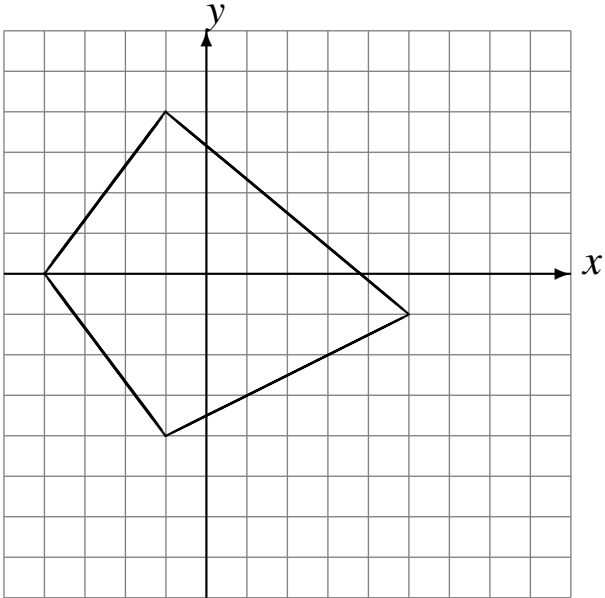

Traslade (3, 5).

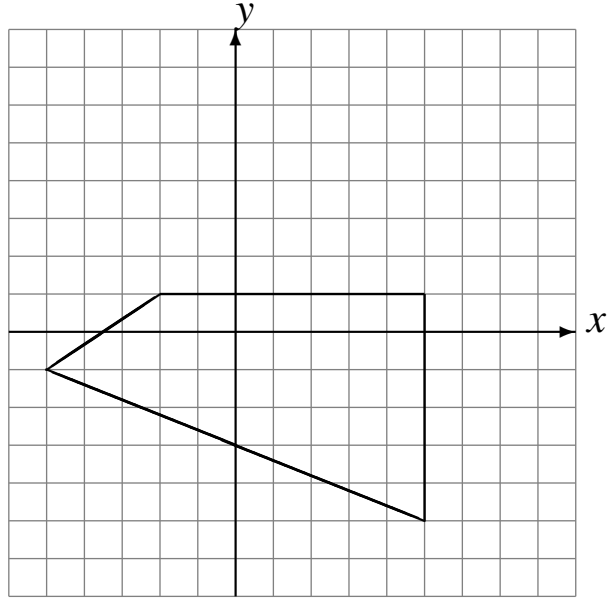

Traslade (4, -5).

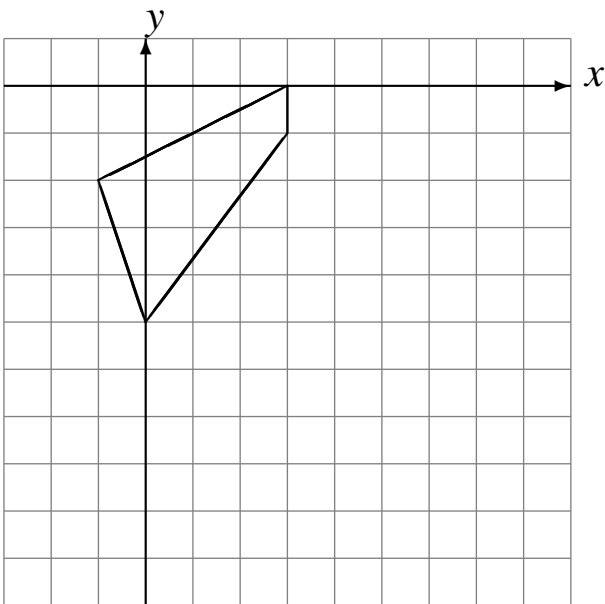

Traslade (1, 6).

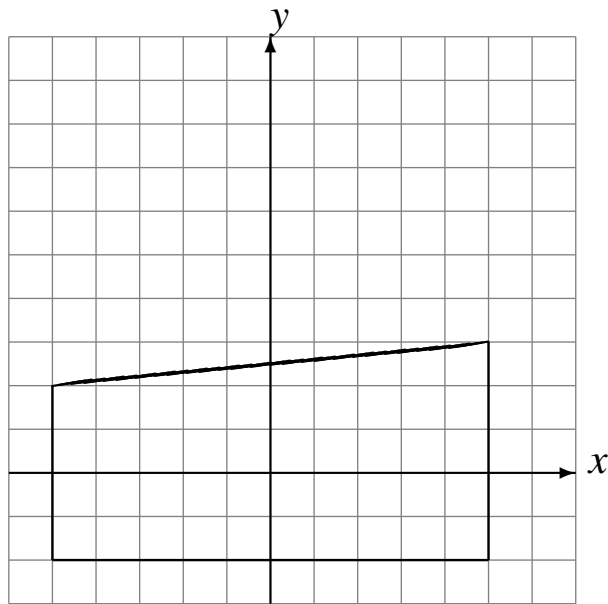

Traslaciones (B) Respuestas

Dibuje cada figura trasladada.

Traslade (3, -2).

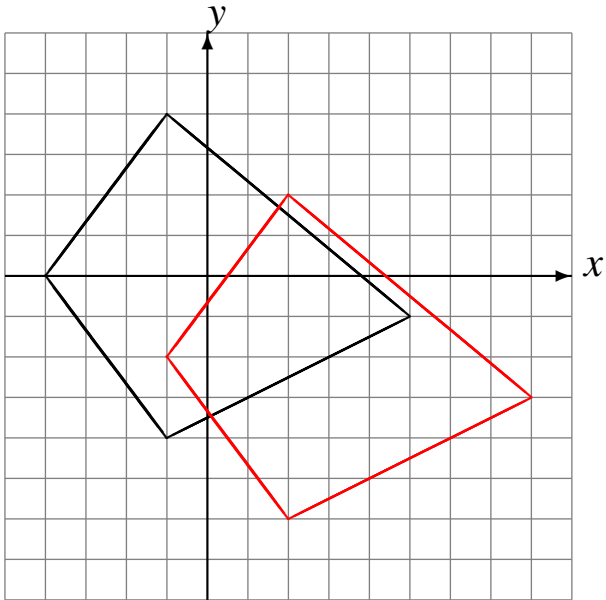

Traslade (3, 5).

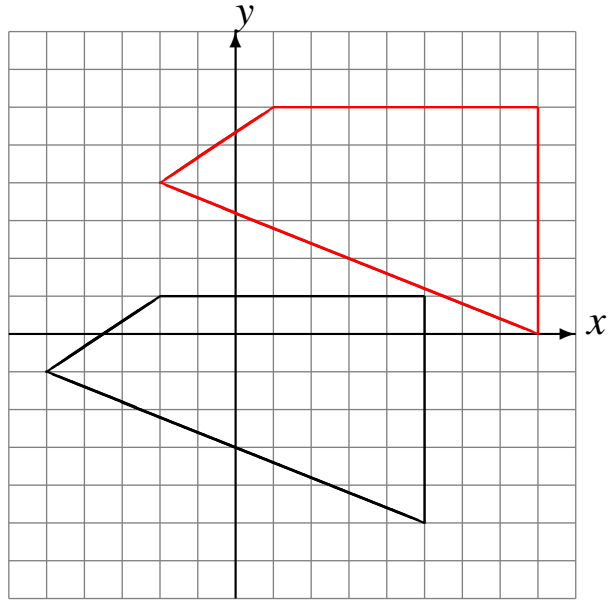

Traslade (4, -5).

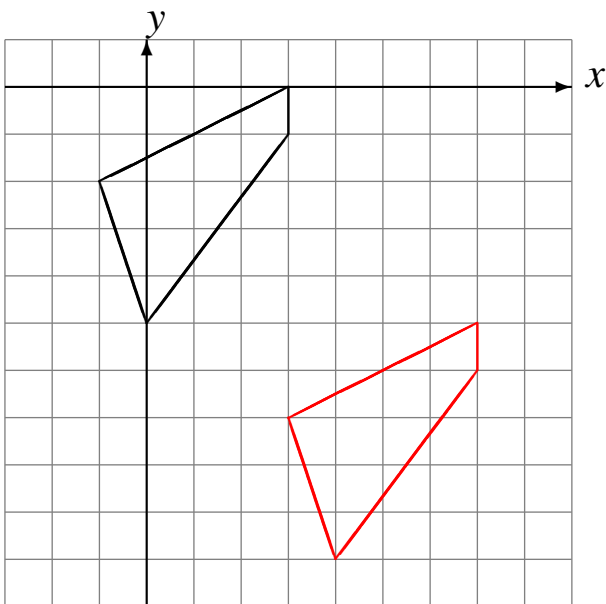

Traslade (1, 6).

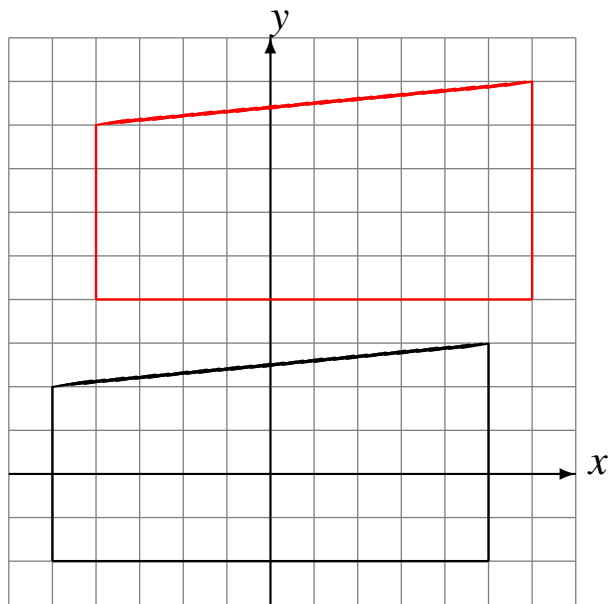

Traslaciones (C)

Dibuje cada figura trasladada.

Traslade (5, -2).

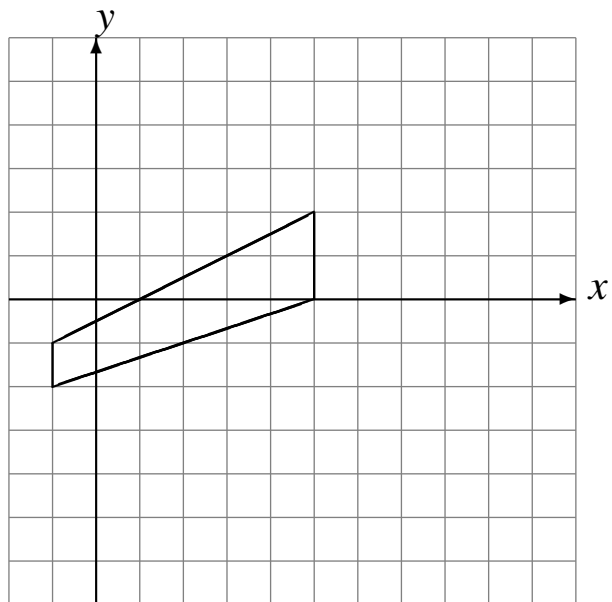

Traslade (2, 0).

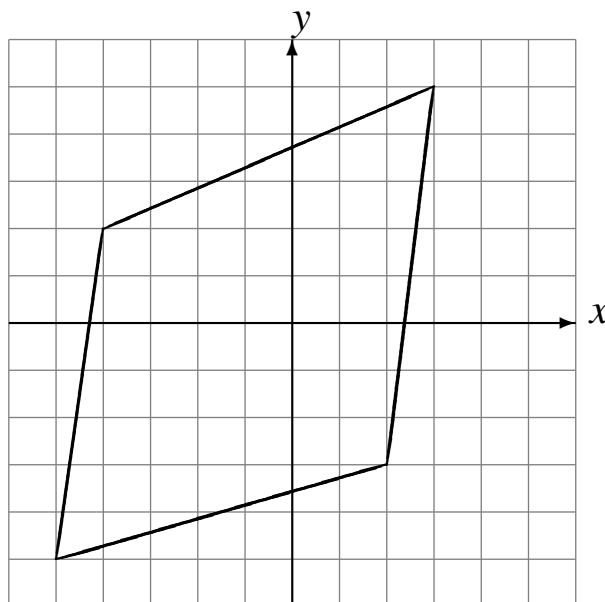

Traslade (0, 1).

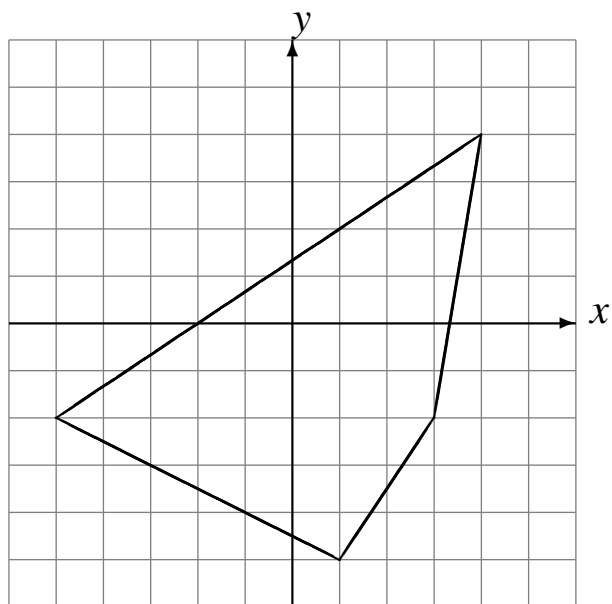

Traslade (4, 5).

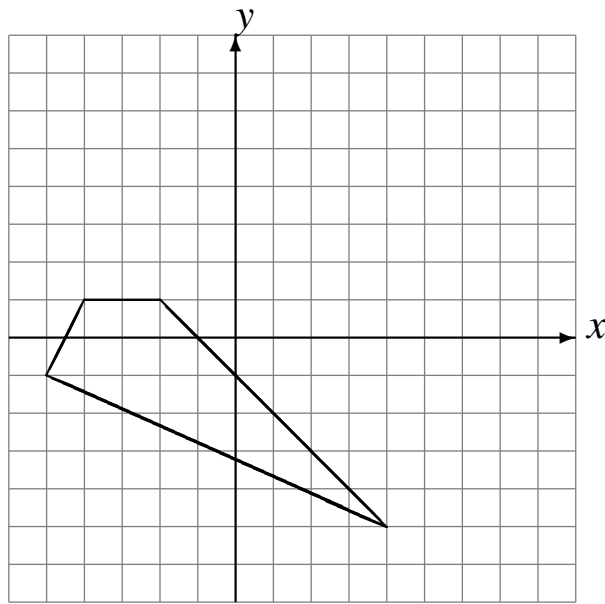

Traslaciones (C) Respuestas

Dibuje cada figura trasladada.

Traslade (5, -2).

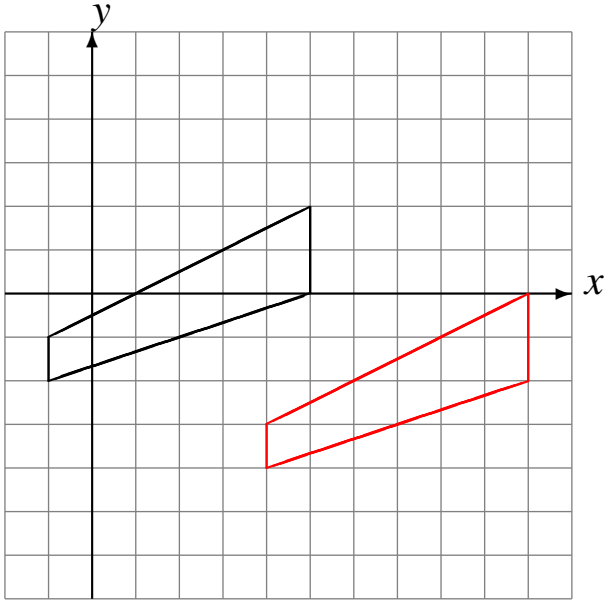

Traslade (2, 0).

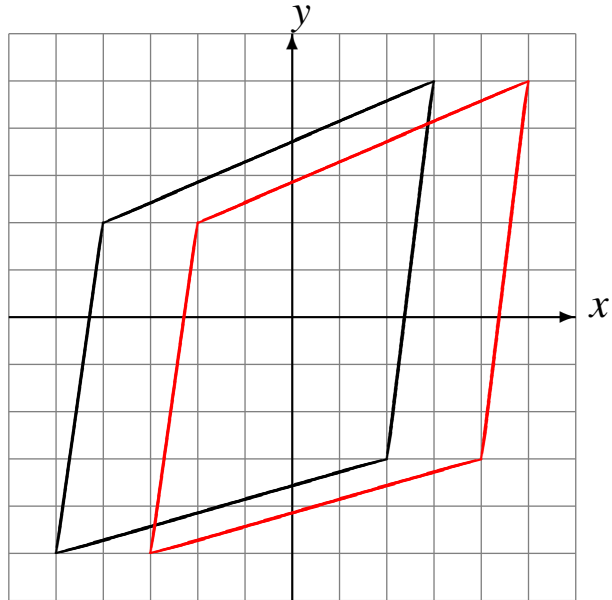

Traslade (0, 1).

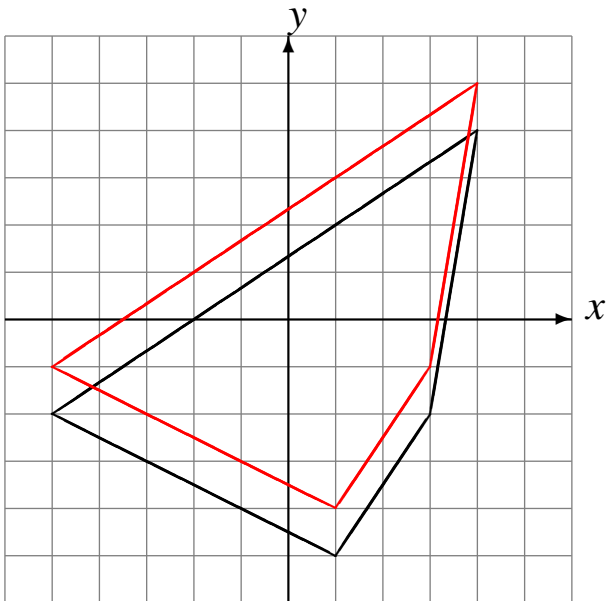

Traslade (4, 5).

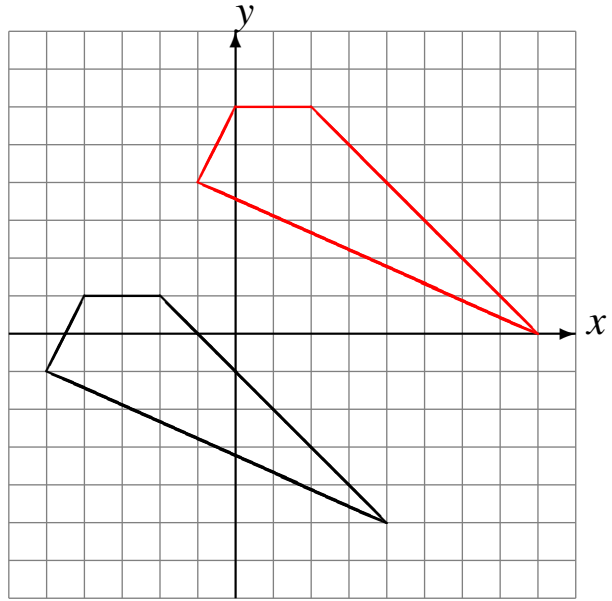

Traslaciones (D)

Dibuje cada figura trasladada.

Traslade $(-4, 1)$.

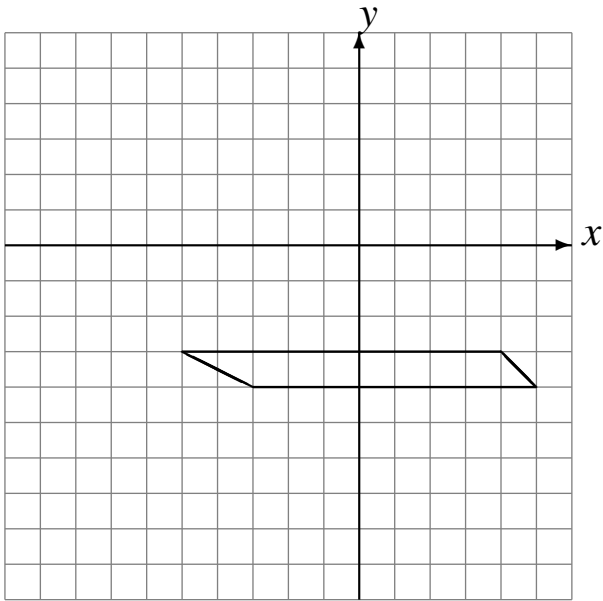

Traslade $(-5, 0)$.

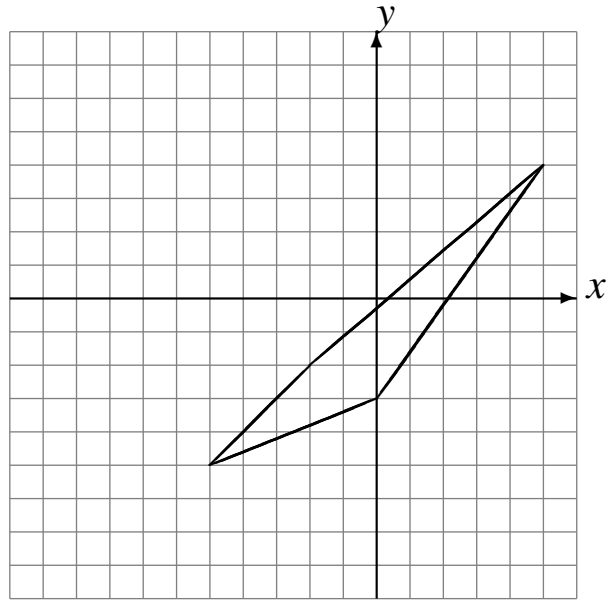

Traslade $(-3, 5)$.

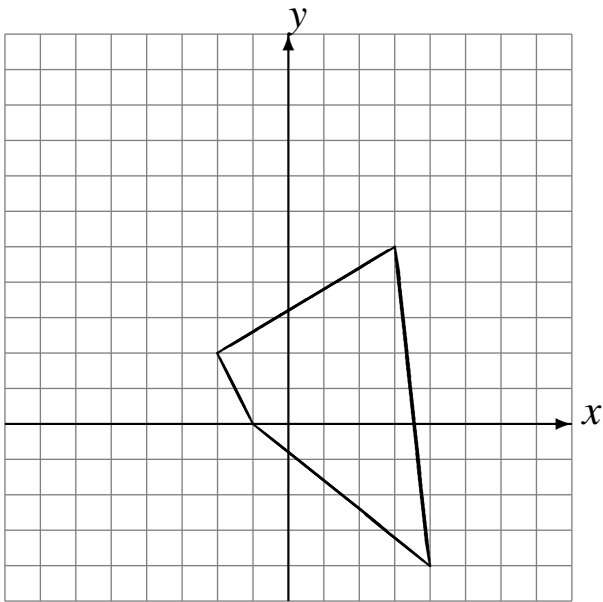

Traslade $(3, 0)$.

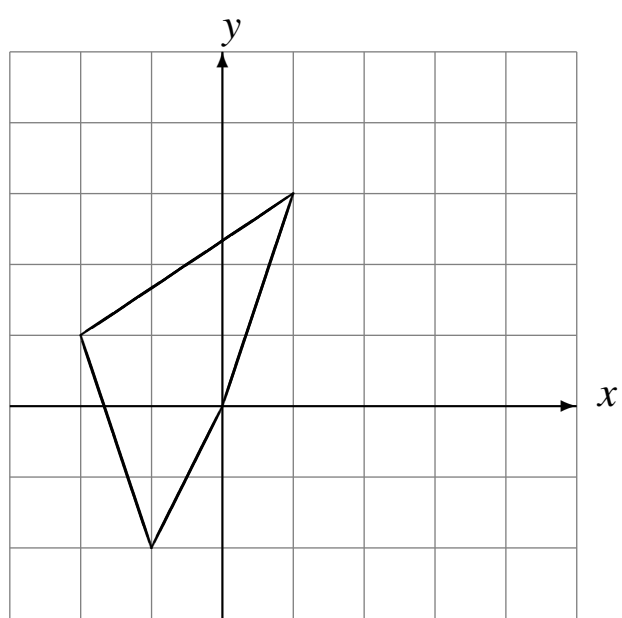

Traslaciones (D) Respuestas

Dibuje cada figura trasladada.

Traslade $(-4, 1)$.

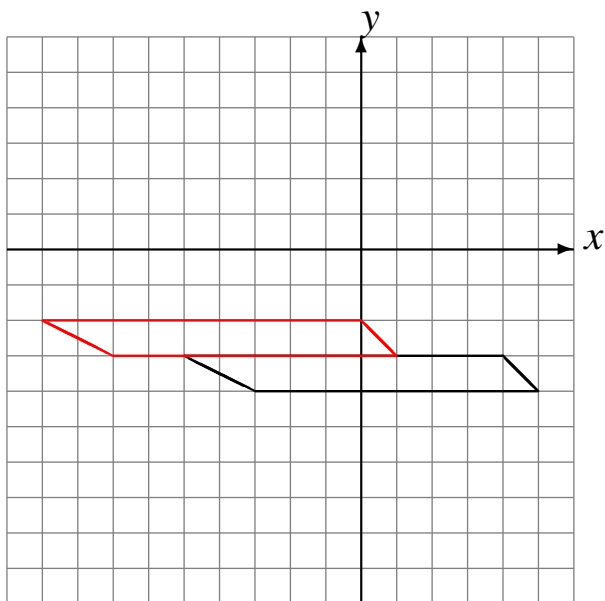

Traslade $(-5, 0)$.

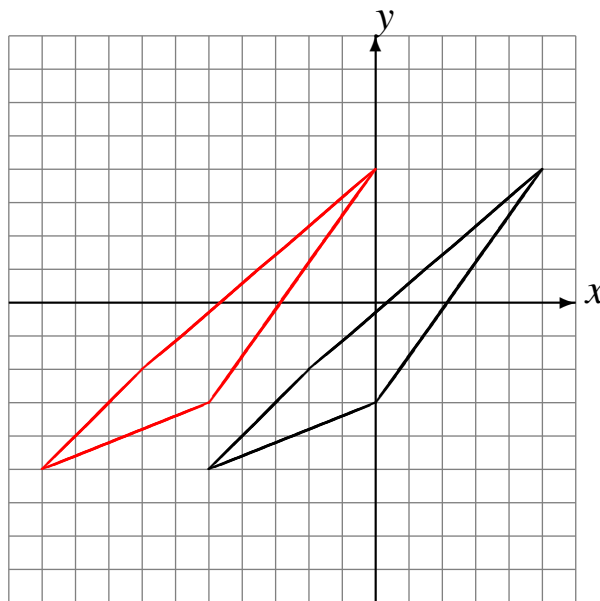

Traslade $(-3, 5)$.

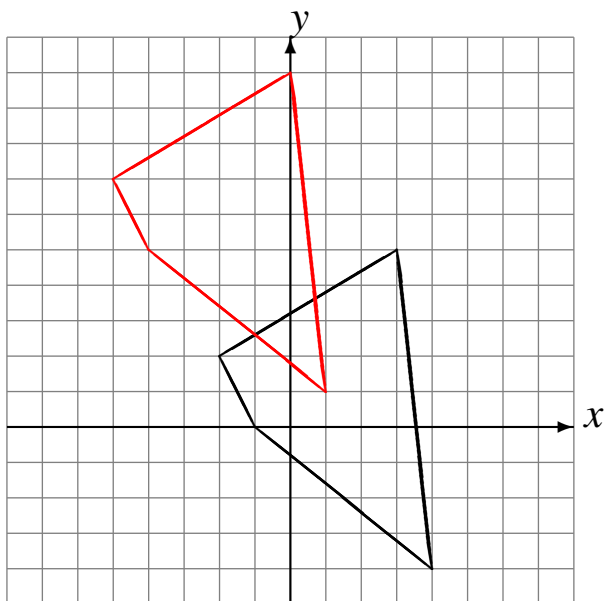

Traslade $(3, 0)$.

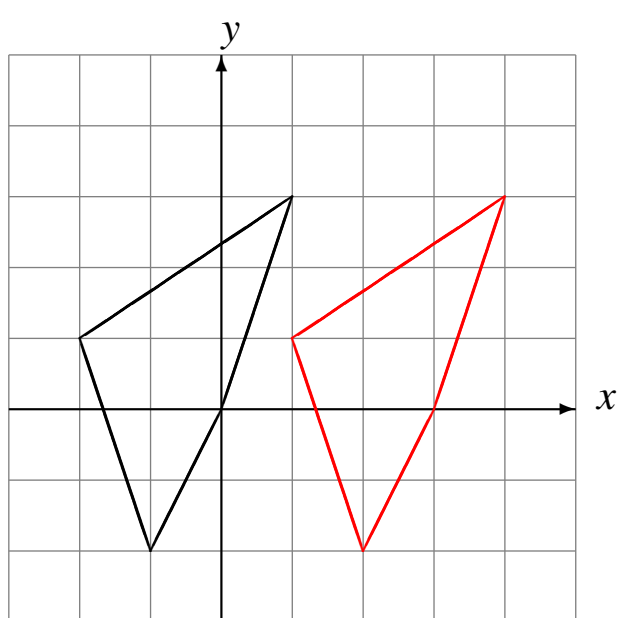

Traslaciones (E)

Dibuje cada figura trasladada.

Traslade $(-1, 4)$.

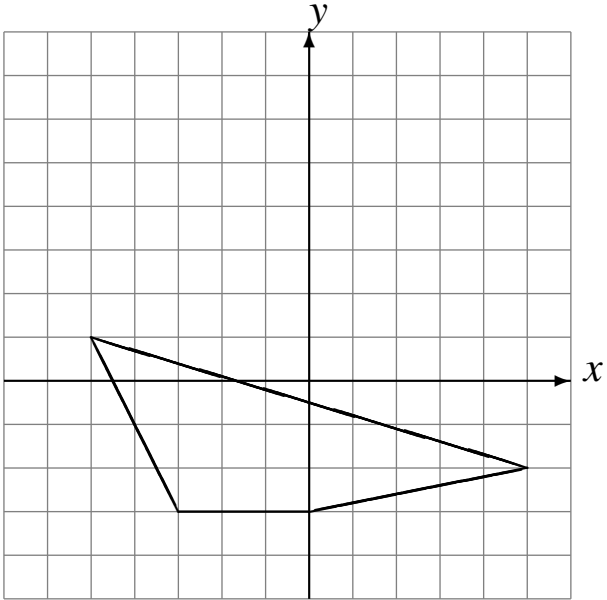

Traslade $(-4, 3)$.

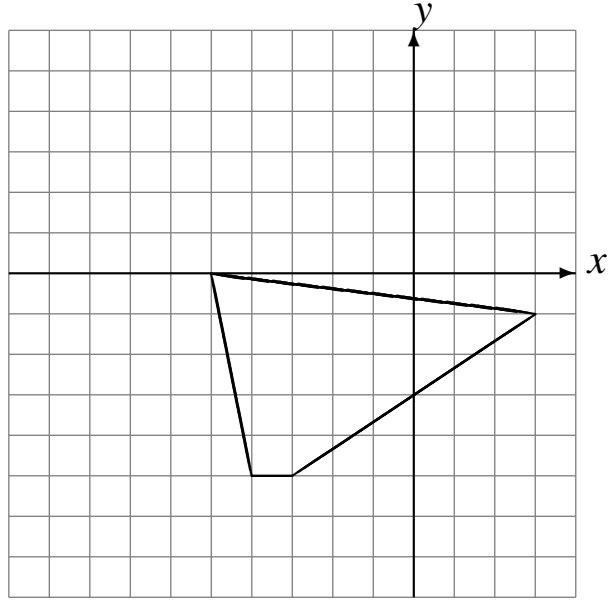

Traslade $(2, -6)$.

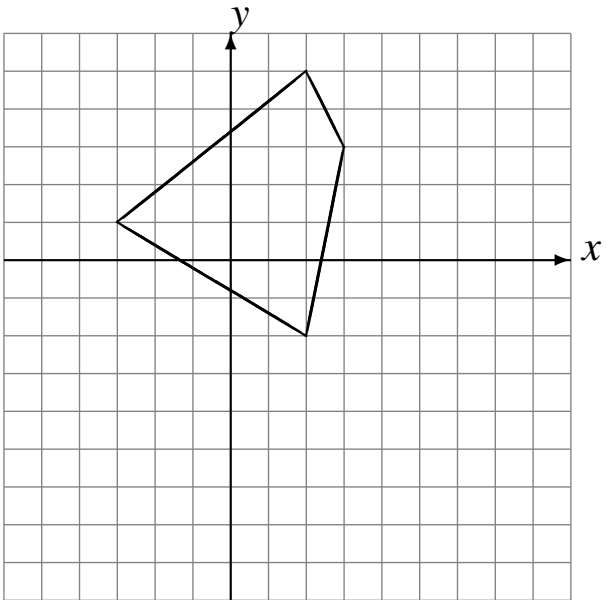

Traslade $(-5, -2)$.

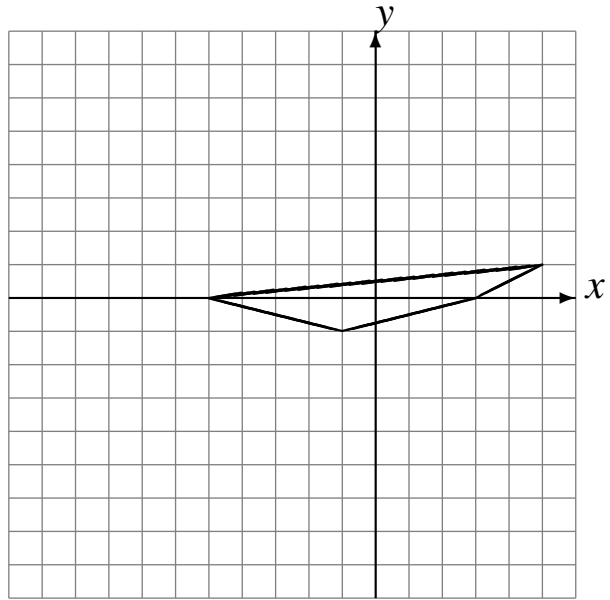

Traslaciones (E) Respuestas

Dibuje cada figura trasladada.

Traslade $(-1, 4)$.

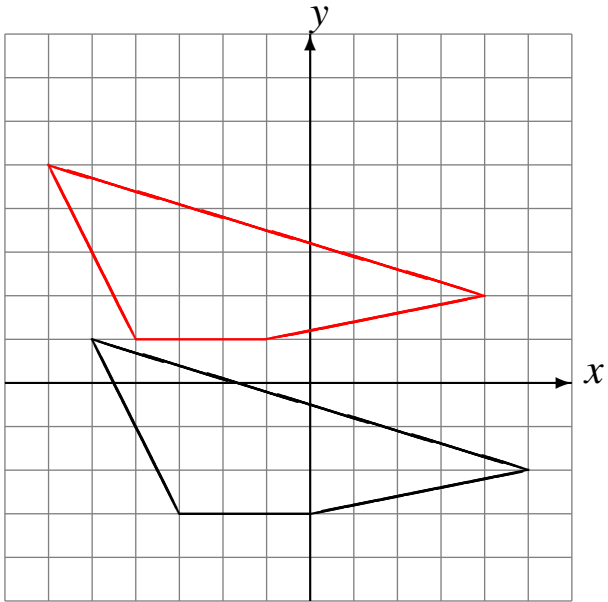

Traslade $(-4, 3)$.

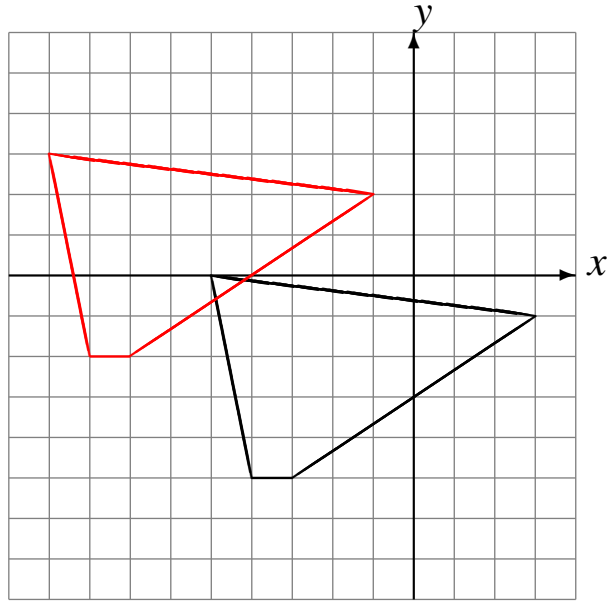

Traslade $(2, -6)$.

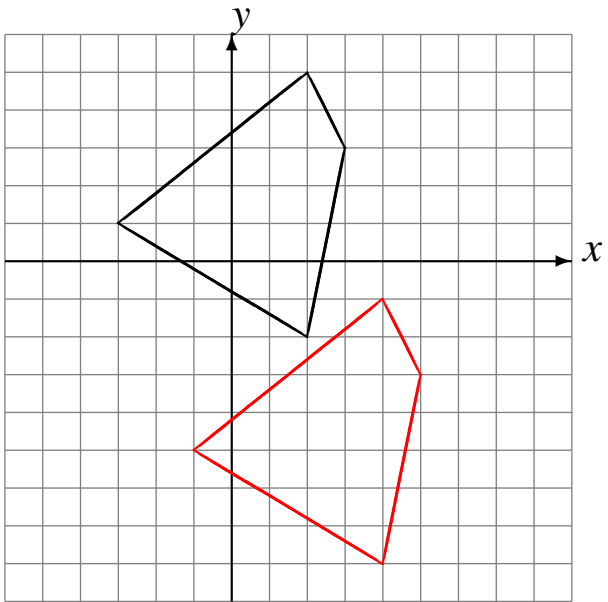

Traslade $(-5, -2)$.

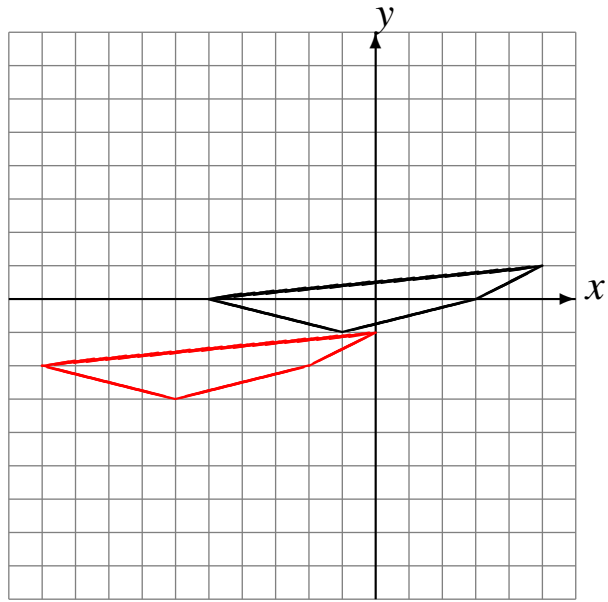

Traslaciones (F)

Dibuje cada figura trasladada.

Traslade $(-3, -4)$.

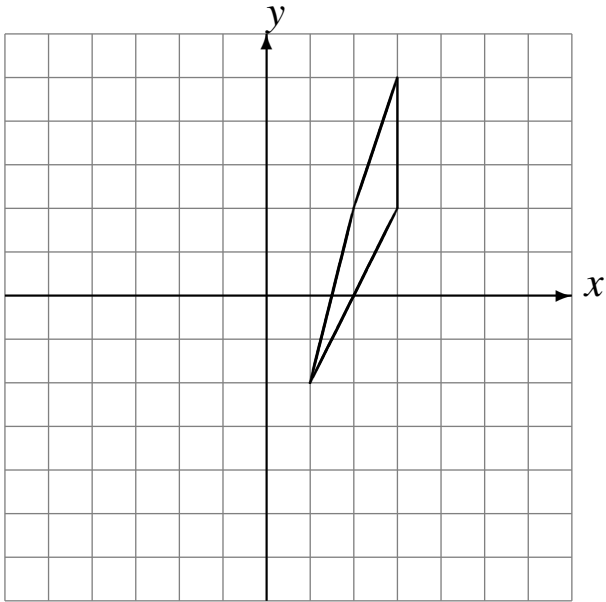

Traslade $(5, 5)$.

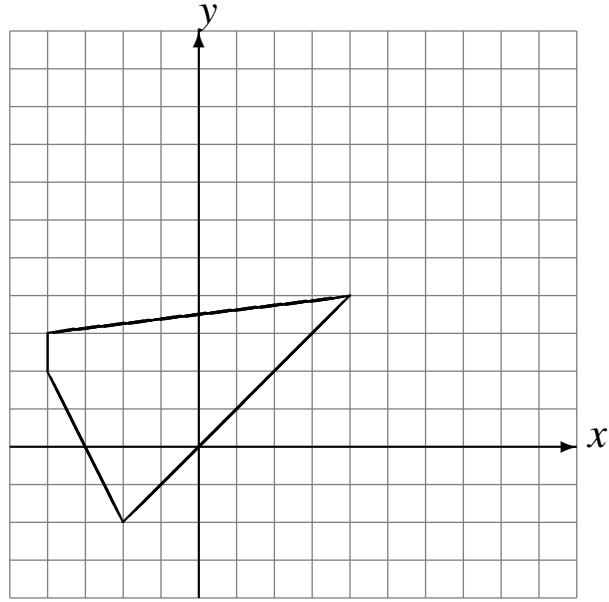

Traslade $(1, -2)$.

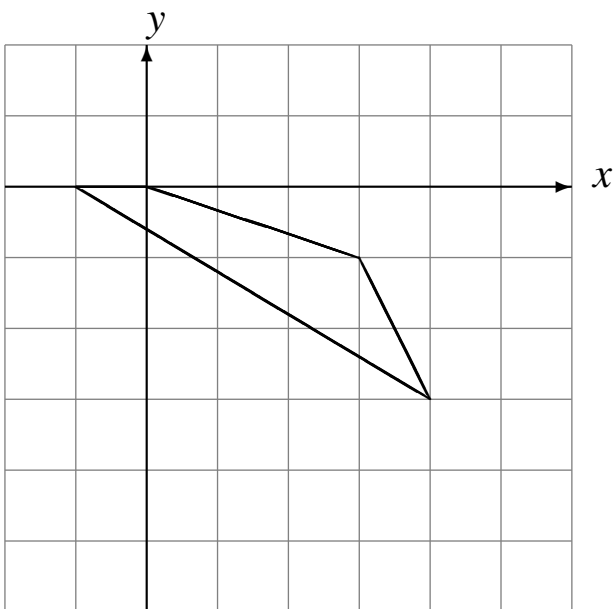

Traslade $(-5, -6)$.

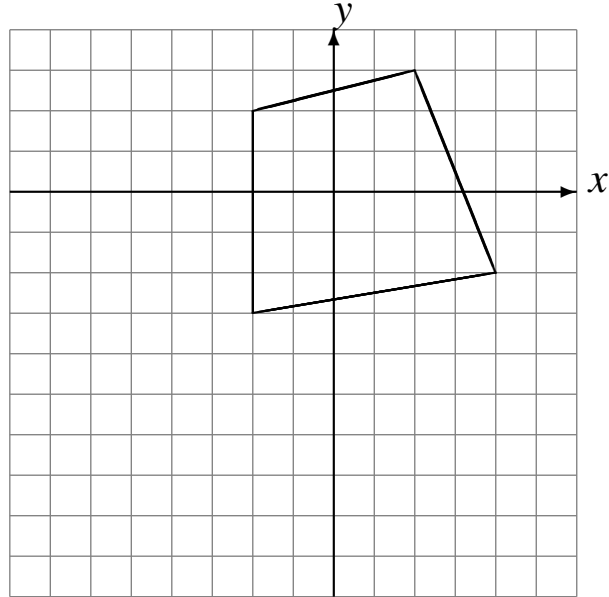

Traslaciones (F) Respuestas

Dibuje cada figura trasladada.

Traslade $(-3, -4)$.

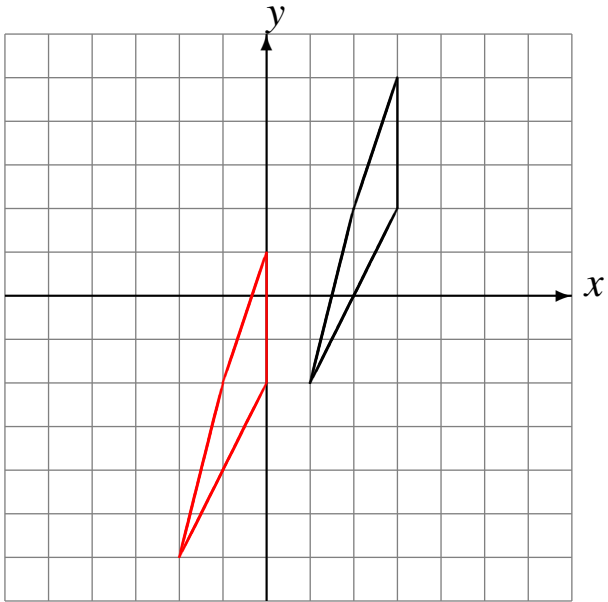

Traslade $(5, 5)$.

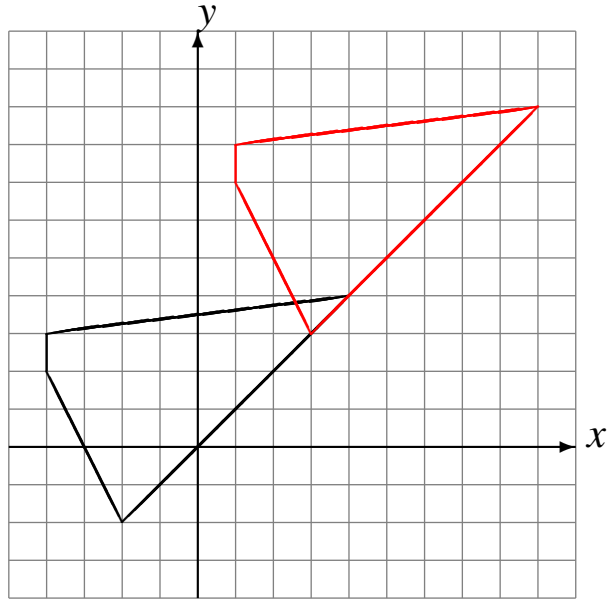

Traslade $(1, -2)$.

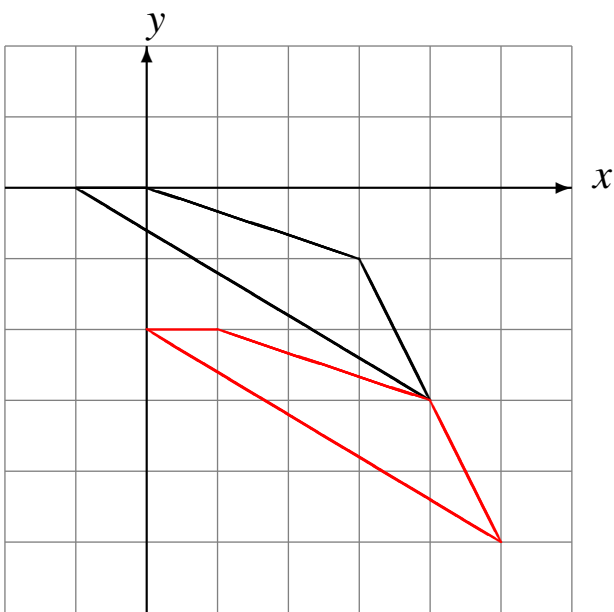

Traslade $(-5, -6)$.

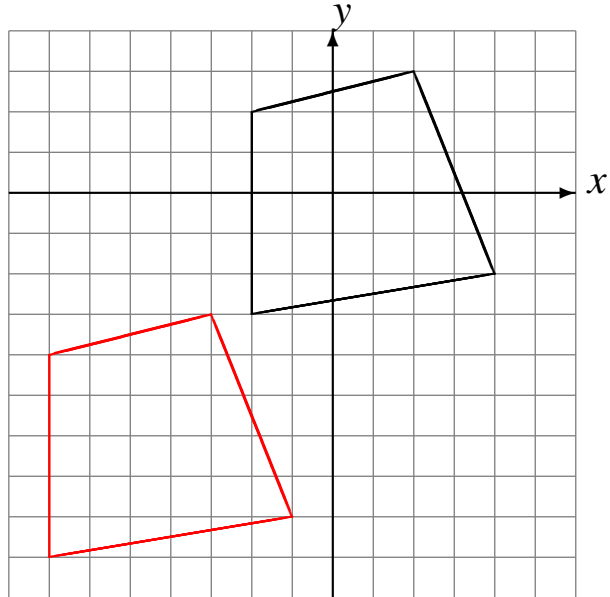

Traslaciones (G)

Dibuje cada figura trasladada.

Traslade $(-5, -3)$.

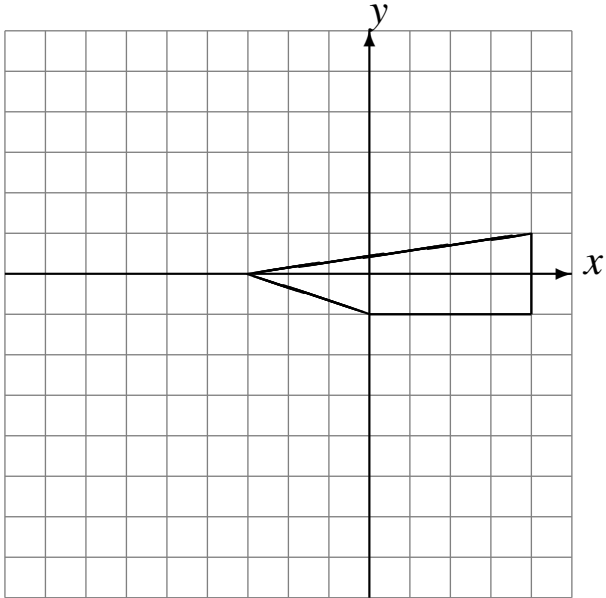

Traslade $(-6, -1)$.

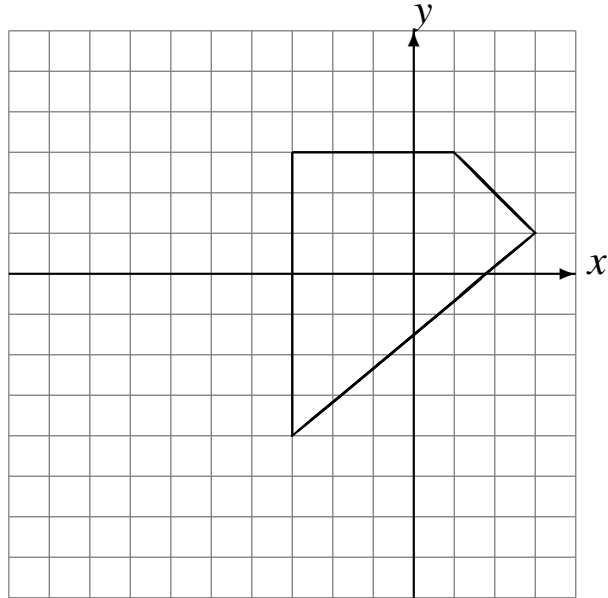

Traslade $(2, -4)$.

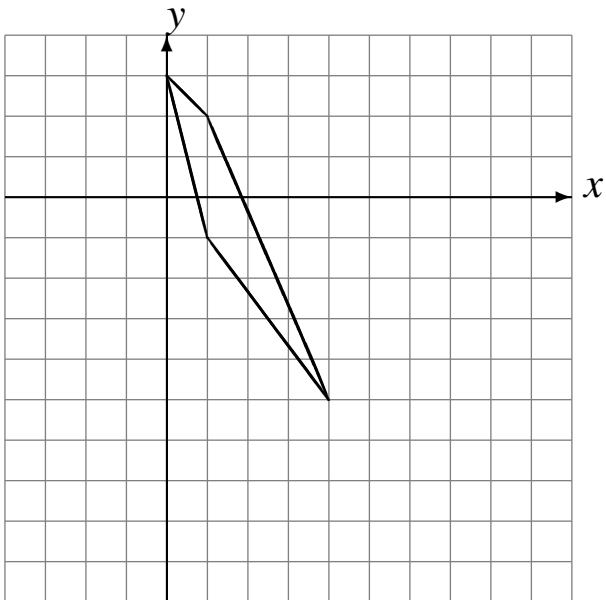

Traslade $(5, -5)$.

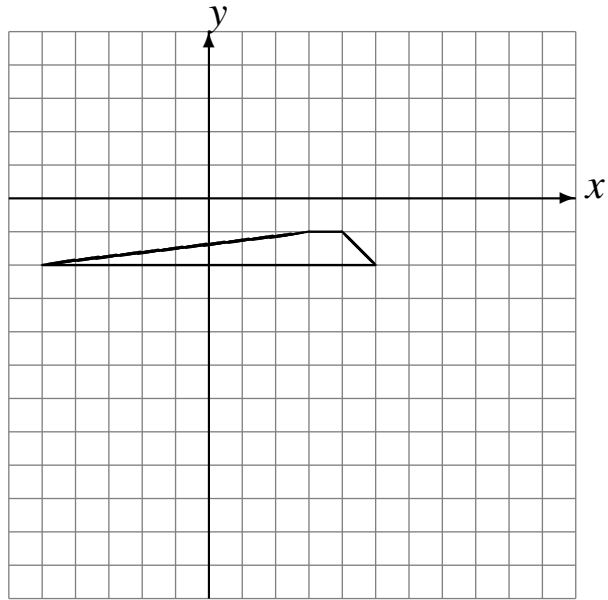

Traslaciones (G) Respuestas

Dibuje cada figura trasladada.

Traslade (-5, -3).

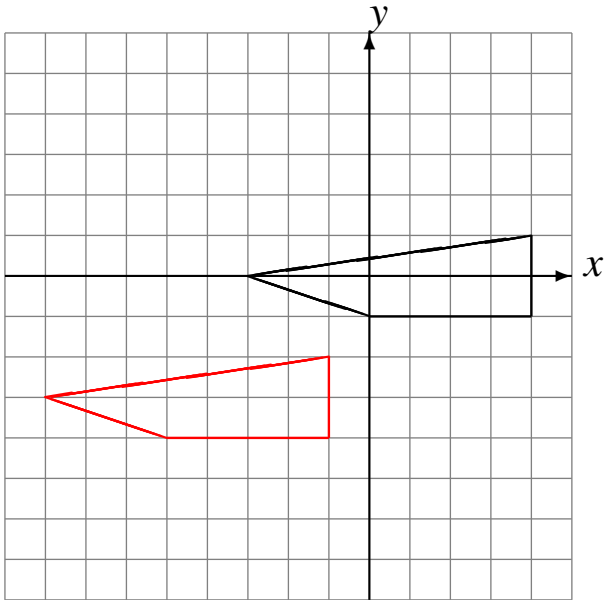

Traslade (-6, -1).

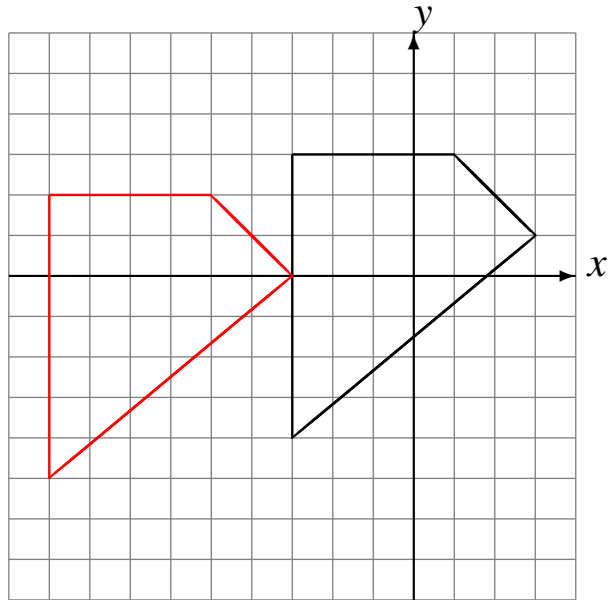

Traslade (2, -4).

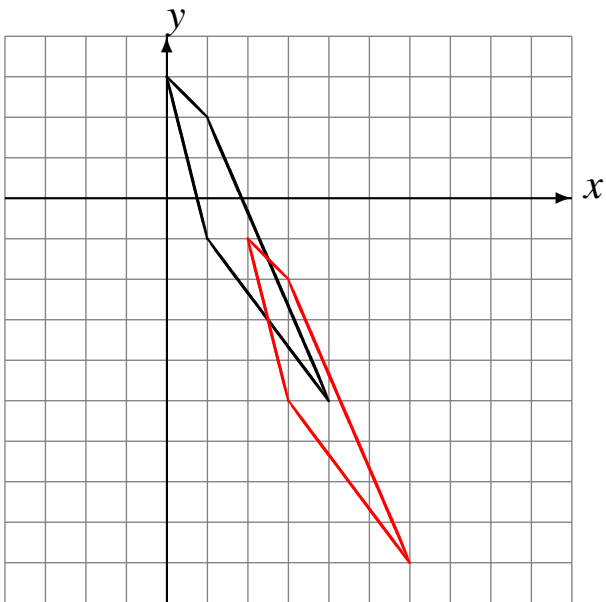

Traslade (5, -5).

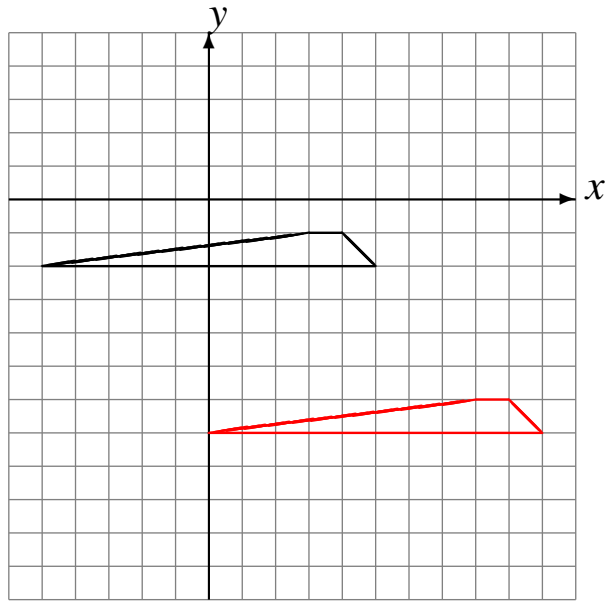

Traslaciones (H)

Dibuje cada figura trasladada.

Traslade (4, 6).

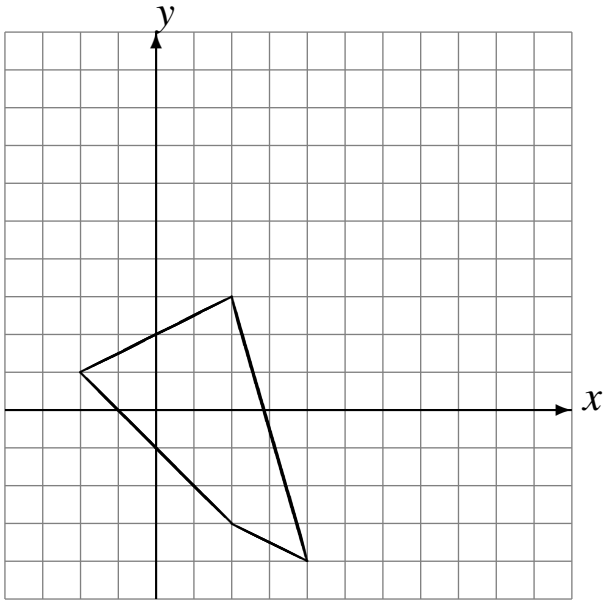

Traslade (4, 6).

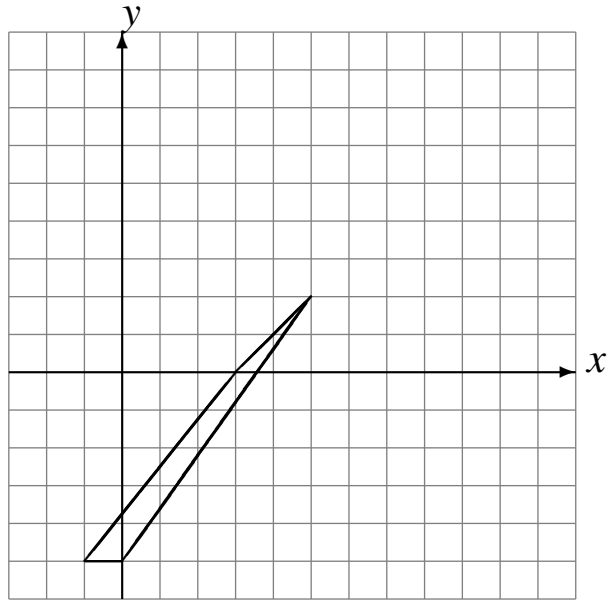

Traslade (-3, -3).

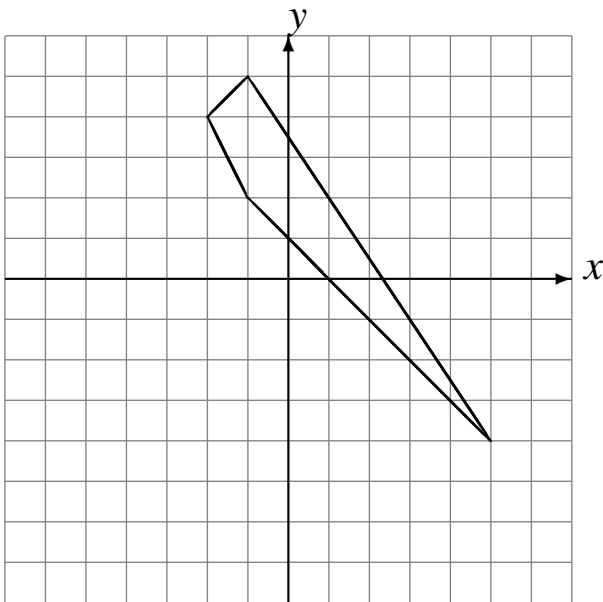

Traslade (4, -6).

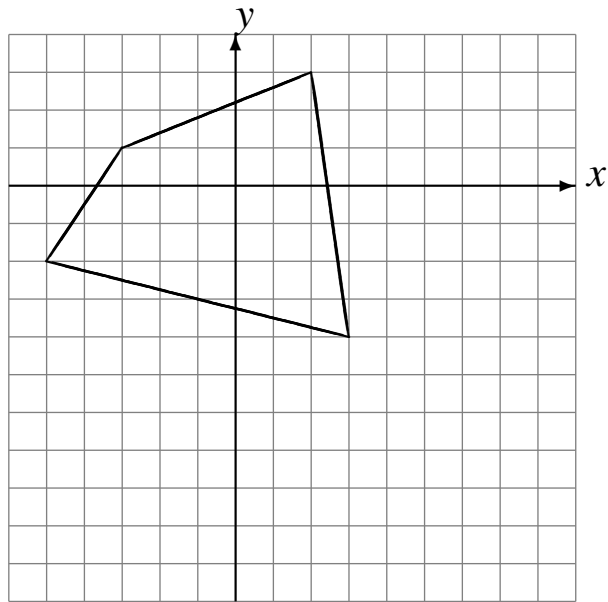

Traslaciones (H) Respuestas

Dibuje cada figura trasladada.

Traslade (4, 6).

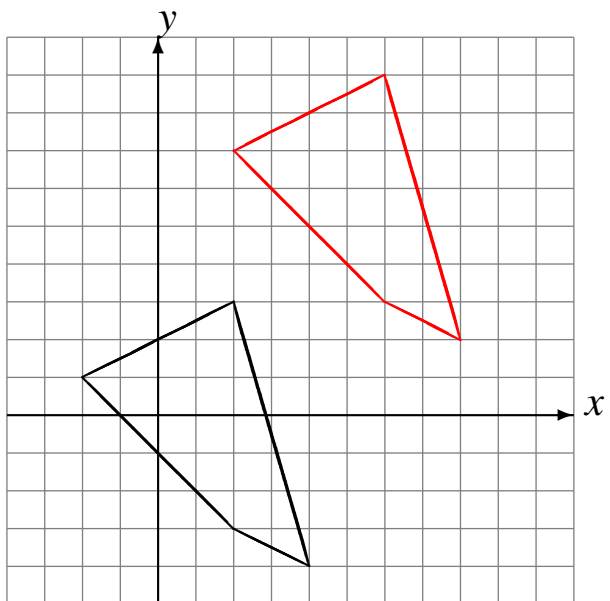

Traslade (4, 6).

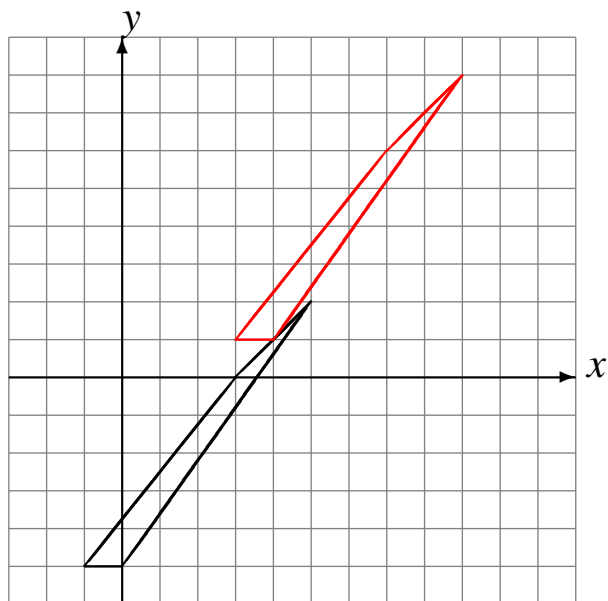

Traslade (-3, -3).

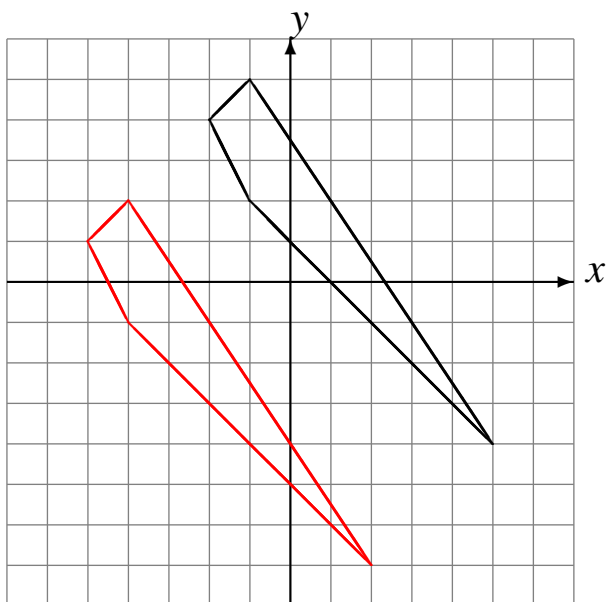

Traslade (4, -6).

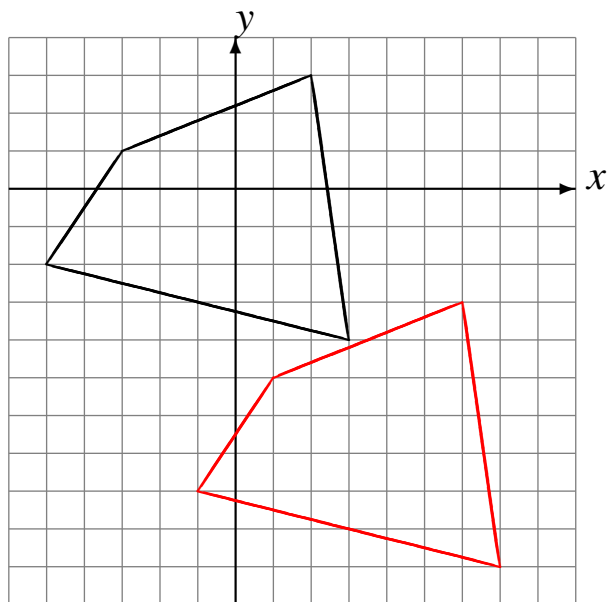

Traslaciones (I)

Dibuje cada figura trasladada.

Traslade (4, 2).

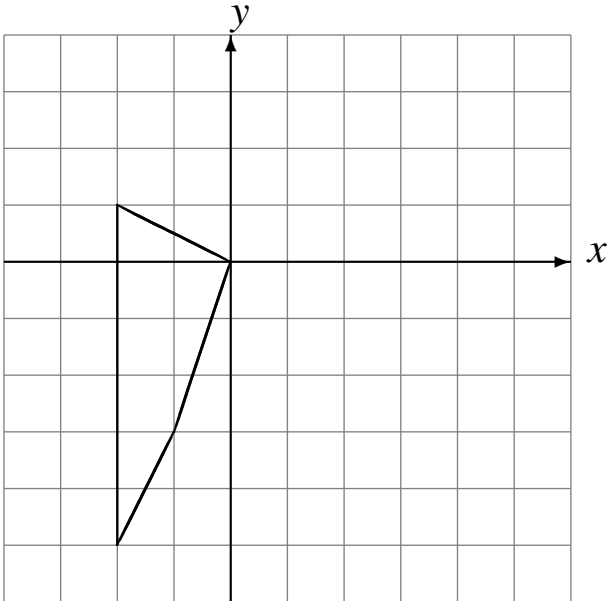

Traslade (-2, -4).

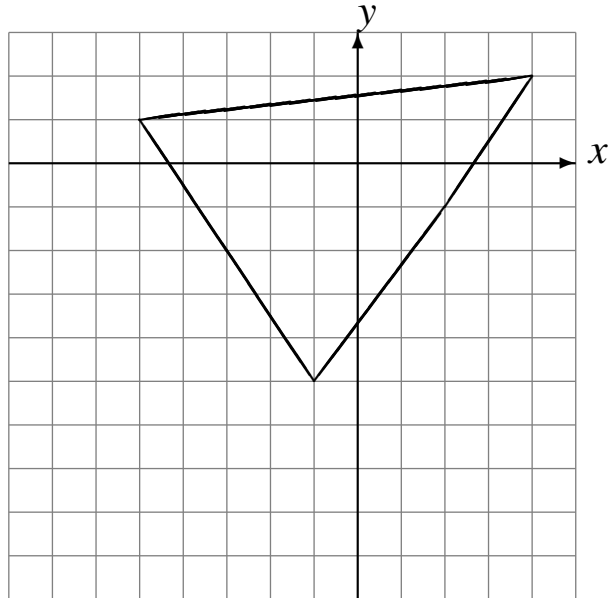

Traslade (2, -5).

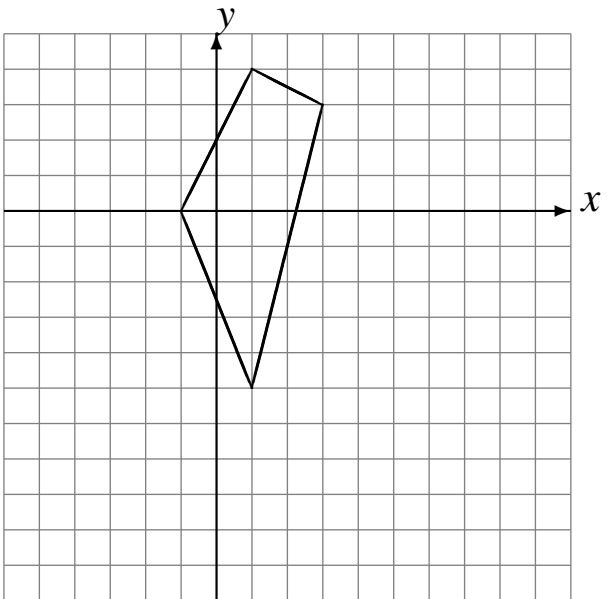

Traslade (1, 3).

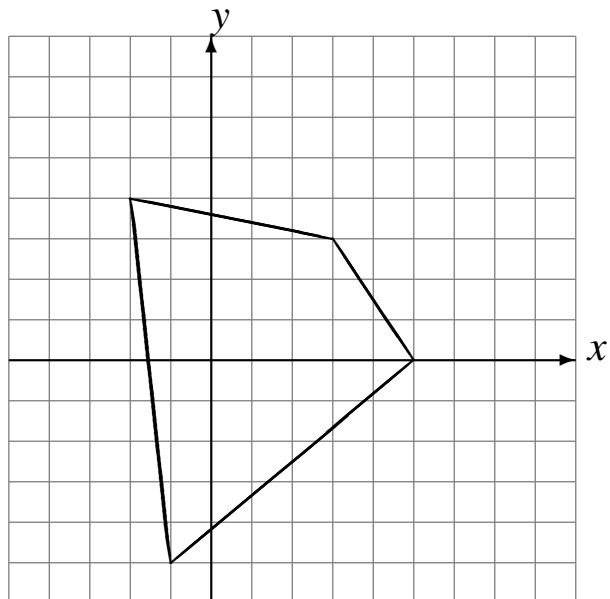

Traslaciones (I) Respuestas

Dibuje cada figura trasladada.

Traslade (4, 2).

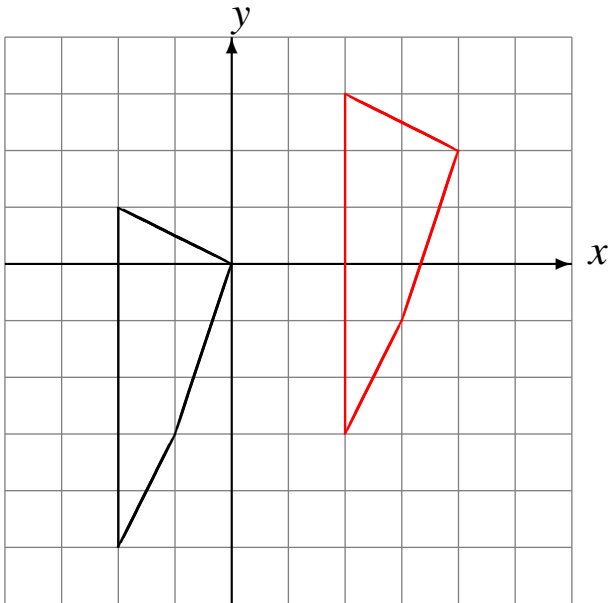

Traslade (-2, -4).

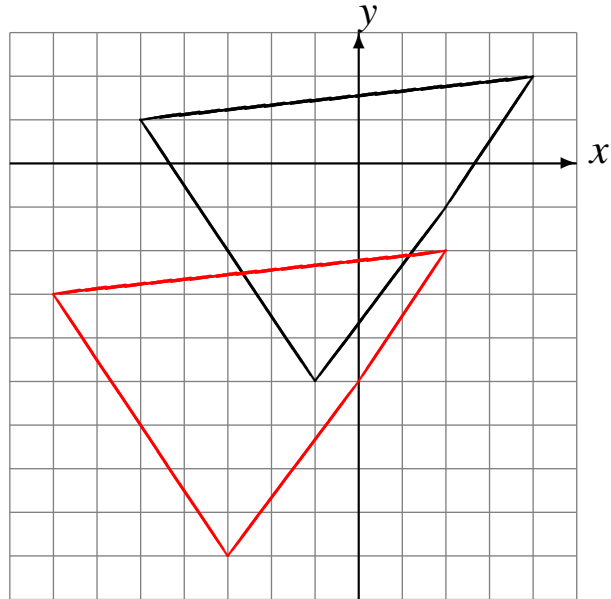

Traslade (2, -5).

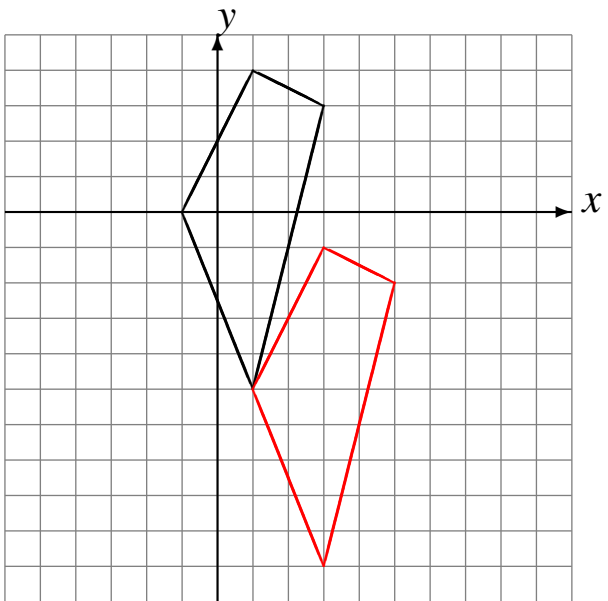

Traslade (1, 3).

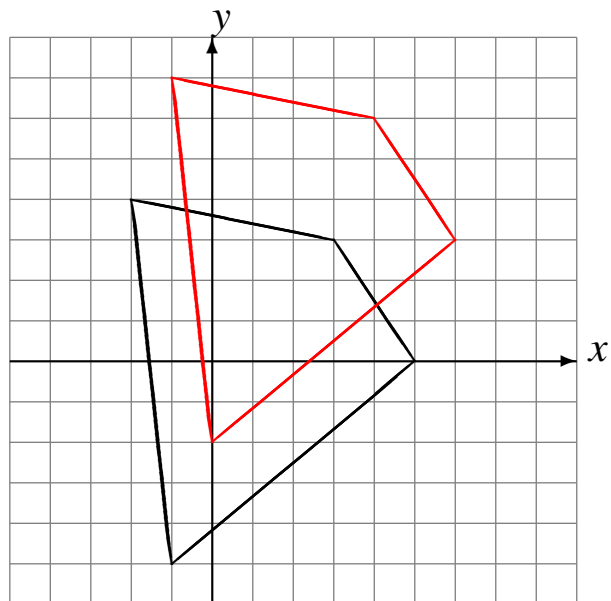

Traslaciones (J)

Dibuje cada figura trasladada.

Traslade (-5, 6).

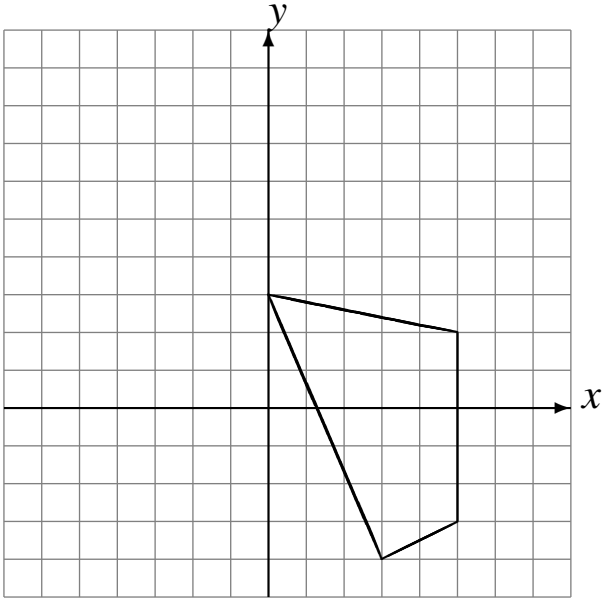

Traslade (4, -4).

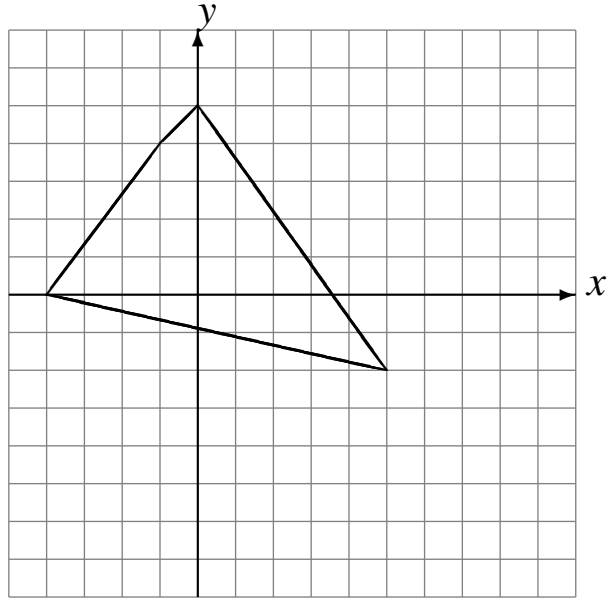

Traslade (-2, 2).

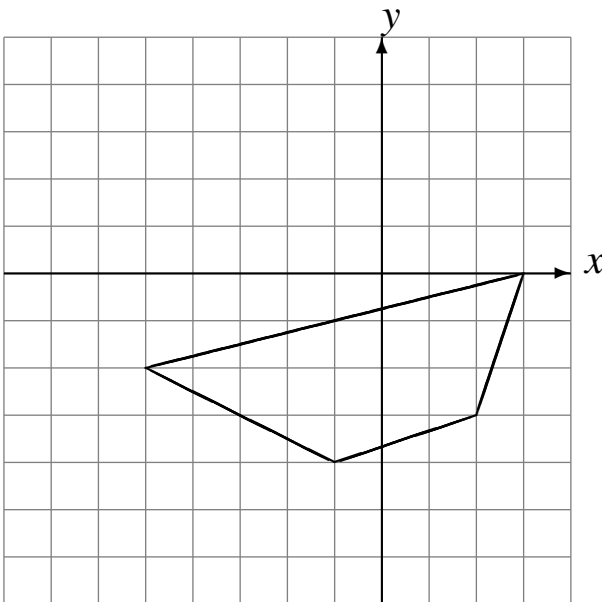

Traslade (3, -5).

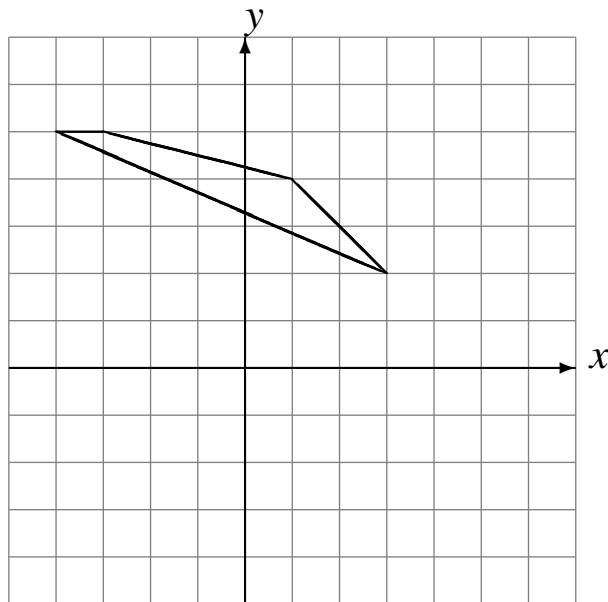

Traslaciones (J) Respuestas

Dibuje cada figura trasladada.

Traslade $(-5, 6)$.

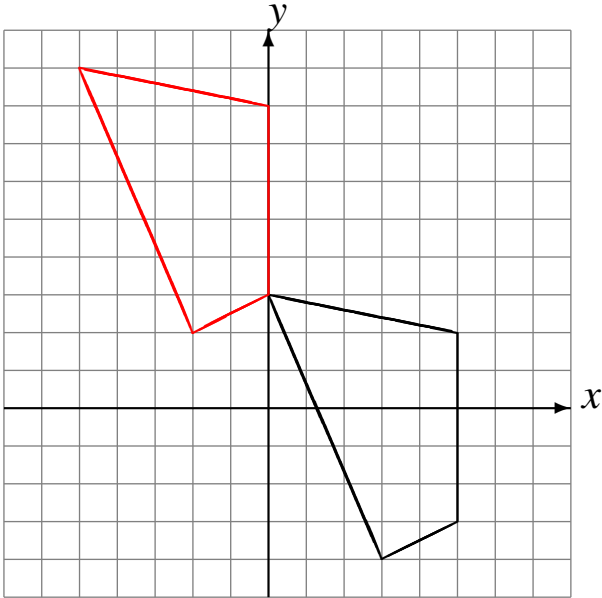

Traslade $(4, -4)$.

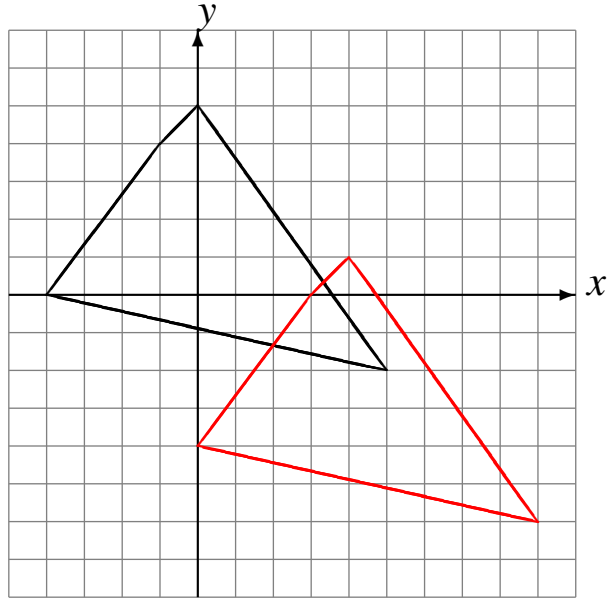

Traslade $(-2, 2)$.

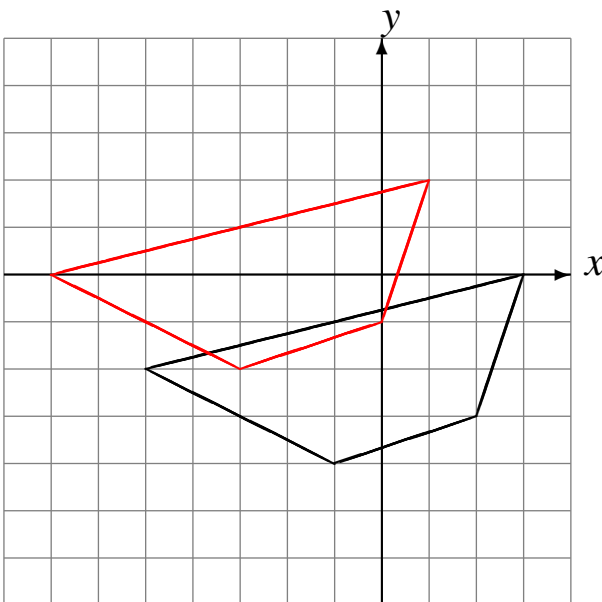

Traslade $(3, -5)$.

