

# Traslaciones (A)

Dibuje cada figura trasladada.

Traslade  $(1, -2)$ .

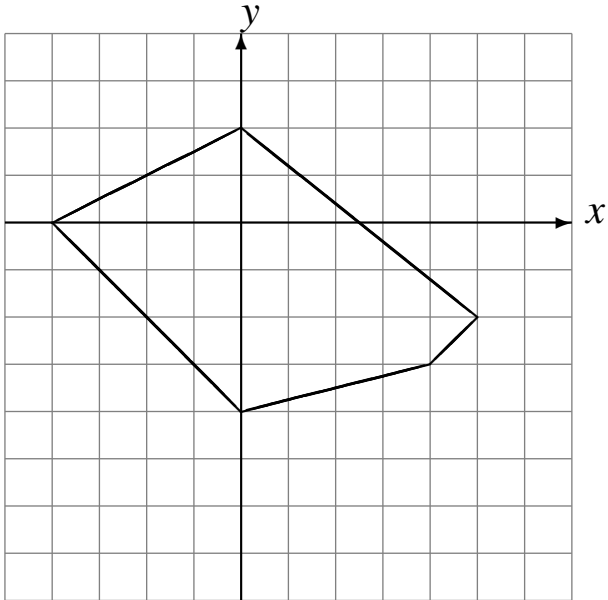

Traslade  $(-6, 0)$ .

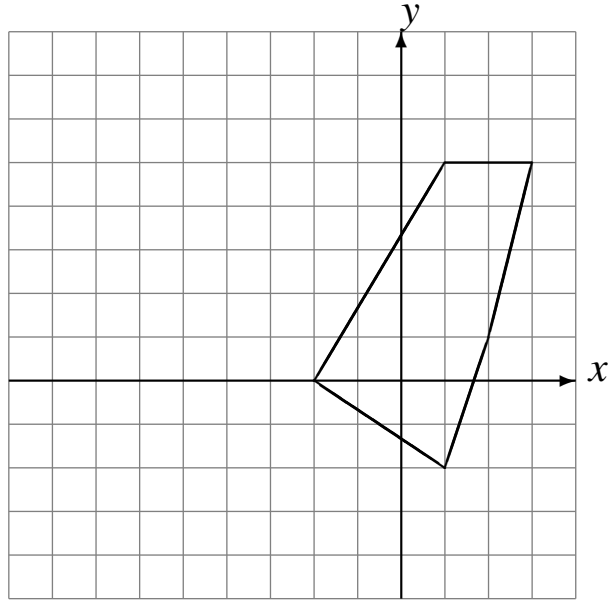

Traslade  $(-5, 6)$ .

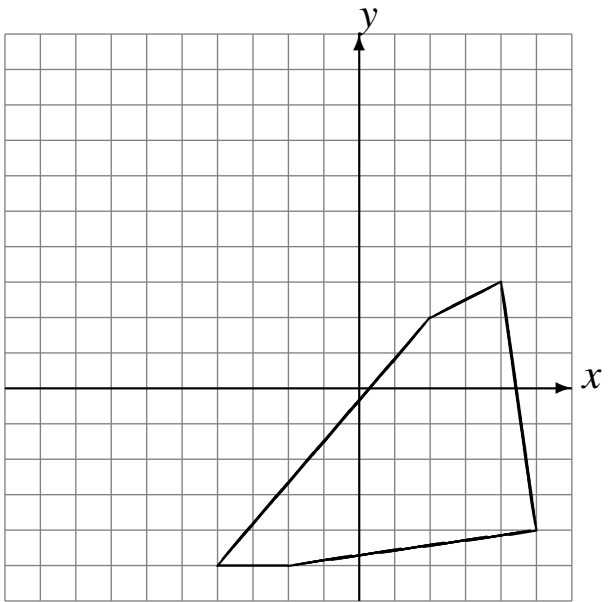

Traslade  $(0, 5)$ .

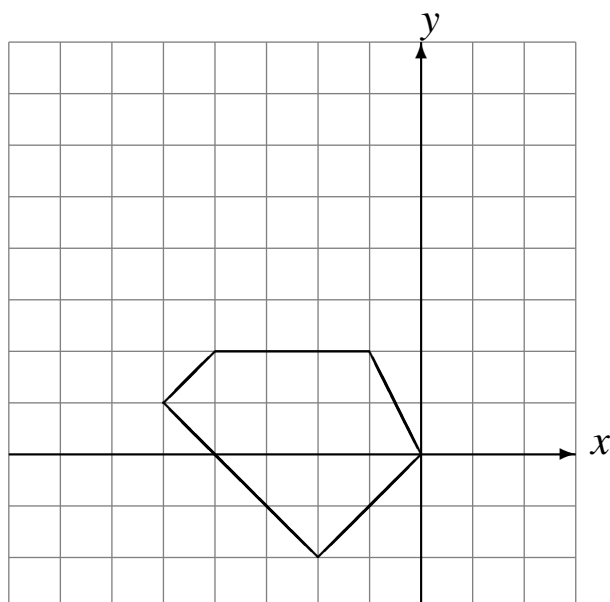

# Traslaciones (A) Respuestas

Dibuje cada figura trasladada.

Traslade  $(1, -2)$ .

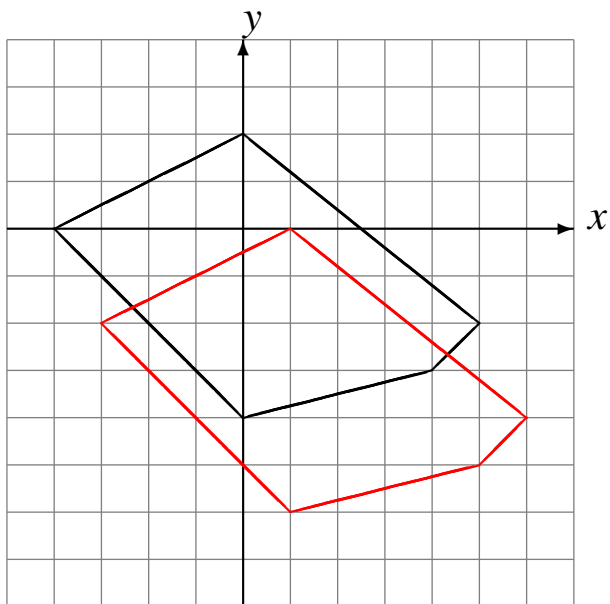

Traslade  $(-6, 0)$ .

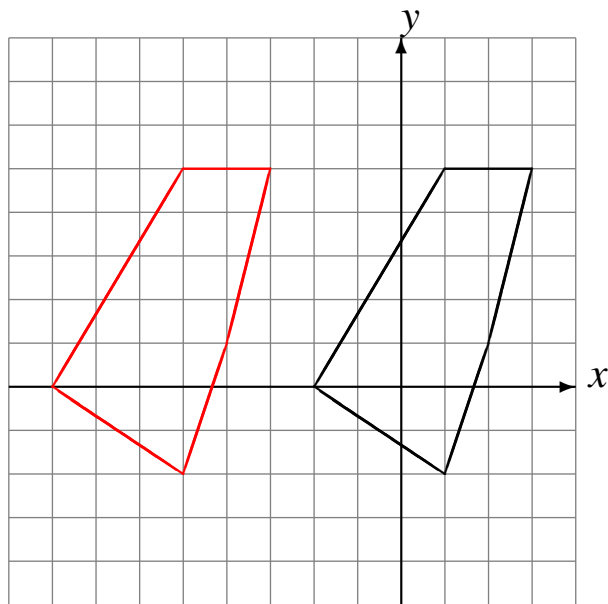

Traslade  $(-5, 6)$ .

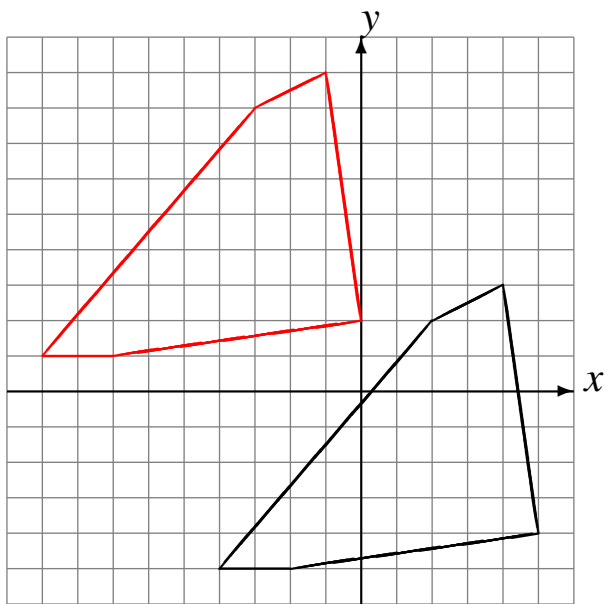

Traslade  $(0, 5)$ .

